

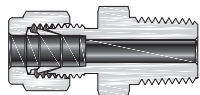

Обжимные фитинги

Двухкольцевые

Содержание



Штуцер с внешней резьбой

8

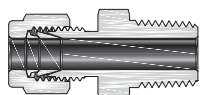

Фитинги с внешней резьбой для термопар

21

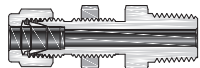

Штуцер с внешней резьбой и монтажом на панель

23

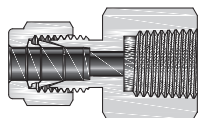

Фитинг с внутренней резьбой

25

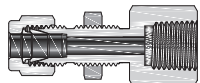

Фитинг с внутренней резьбой с креплением на панель

30

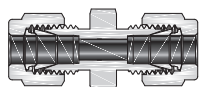

Муфты

3F



Муфты с монтажом на панель

31

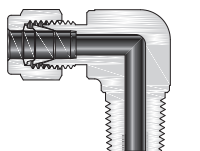

Угольник с внешней резьбой

35

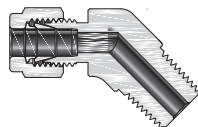

Угольник под 45° с внешней резьбой

38

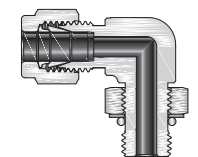

Позиционируемый угольник с внешней резьбой

39

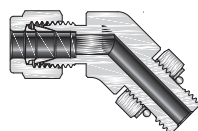

Позиционируемый угольник под 45° с внутренней резьбой

41

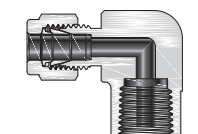

Угольник с внутренней резьбой

42

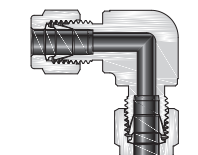

Соединительный угольник

43

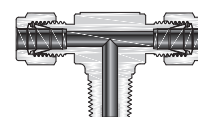

Тройник с внешней резьбой снизу

45

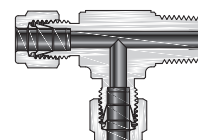

Тройник с внешней резьбой сбоку

46

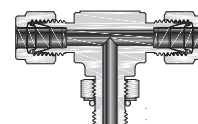

Позиционируемый тройник с внешней резьбой снизу

47

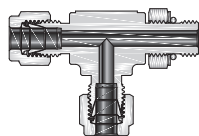

Позиционируемый тройник с внешней резьбой сбоку

47

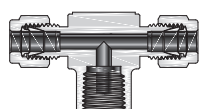

Тройник с внутренней резьбой снизу

49

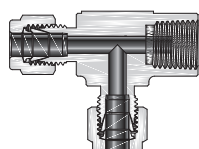

Тройник с внутренней резьбой сбоку

50

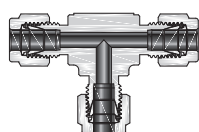

Соединительный тройник

51

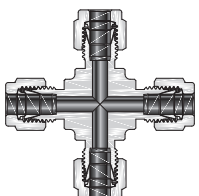

Соединительная крестовина

54

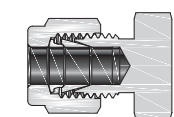

Колпак

55

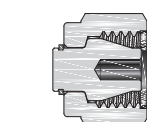

Заглушка

55

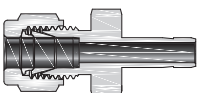

Переходник с трубным адаптером

56

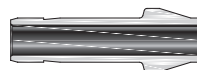

Соединитель для фитингов

58

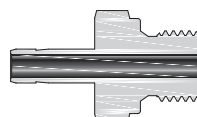

Трубный адаптер с внешней резьбой

59

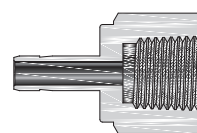

Трубный адаптер с внутренней резьбой

64

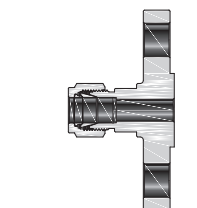

Фланцевый переходник

67

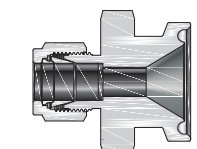

Переходник с санитарного фланца

68

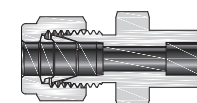

Штуцер под приварку

69

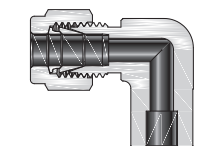

Угольник под приварку



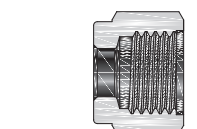





70

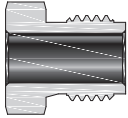

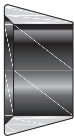
Гайка

71

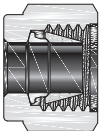
Содержание

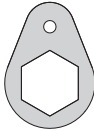
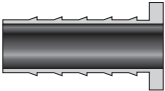
| | | | |
|---|---------------------------------|---|---|
|  | Гайки |  | Комбинированные уплотнительные кольца |
| 72 | | 75 | |
|  | Передние обжимные кольца |  | Уплотнительные медные кольца для внешней резьбы |
| 72 | | 75 | |
|  | Задние обжимные кольца |  | Уплотнительные медные кольца для манометрической резьбы |
| 72 | | 76 | |
|  | Комплект обжимных колец и гайки |  | Уплотнительные кольца из эластомеров |
| 73 | | 77 | |
|  | Набор обжимных колец |  | Фиксатор для монтажа на панель |
| 73 | | 78 | |
|  | Вставки для мягких трубок | | |
| 74 | | | |

Характеристики

- ❖ Обжимные фитинги уплотняются металл по металлу без использования каких-либо эластомеров
- ❖ Обжимные фитинги CIR-LOK спроектированы для работы при давлении значительно превышающем давление трубки
- ❖ Стандартный дизайн для всего диапазона размеров трубок
- ❖ Жёсткость трубок не должна превышать 85 по Роквеллу
- ❖ Доступны размеры фитингов от 1/16 до 2 дюймов и от 2 до 50 мм.
- ❖ Фитинги могут быть изготовлены из нержавеющей стали, углеродистой стали, латуни, алюминия, Хастеллоя, Инкоя и других сплавов.
- ❖ Подсеребрённая резьба на гайке фитинга для уменьшения усилия при затяжке и исключения эффекта холодной сварки.
- ❖ Фитинги прекрасно работают в вакуумных системах и в системах с сильной вибрацией.

Производительность

- ❖ Гидравлический тест (превышение рабочего давления в 1.5 раза): утечек нет
- ❖ Сборка разборка фитингов 50 раз: утечек нет
- ❖ Тест на четырёхкратное превышение давления: утечек нет
- ❖ Тестирование вакуумом при $1 \cdot 10^{-8}$: утечки нет
- ❖ Тестирование азотом при полуторакратном превышении давления: утечек нет
- ❖ Тестирование с импульсной и вибрационной нагрузкой (импульсы 0,5 - 1.7 Гц, вибрация 23-47 Гц): Утечек нет
- ❖ Тест на термоцикличность. Нагрев системы до +80 °С резкое охлаждение до -25 °С и тест на герметичность: утечек нет
- ❖ Герметичность при вибрации. Система вибрирует с частотой 45 Гц под давлением $20 \cdot 10^6$ циклов: утечек нет
- ❖ Воздействие открытым огнём (согласно стандарту BS ISO 19921): утечек нет
- ❖ Тест на коррозию в течении 168ч: Видимых следов коррозии нет
- ❖ Подводный тест (эквивалент глубины 3048): Утечки гелия нет

Стандартные используемые материалы

| Материал | Заготовка ⁽¹⁾ | Поковки ⁽²⁾ |
|-----------------------------------|------------------------------------|-------------------------------------|
| Нержавеющая сталь марки 316 | ASTM A276 ASME SA479, EN 1.4401 | ASTM A182 ASME SA182, EN 1.4401 |
| Сплав 20 | ASTM B473 | ASTM B462 |
| Сплав 400/R-405 | ASTM B164, ASME SB164 | ASTM B564, ASME SB564 |
| Сплав 600 | ASTM B166, ASME SB166 | ASTM B564, ASME SB564 |
| Сплав 625 | ASTM B446 ⁽³⁾ | ASTM B564, ASMESB564 ⁽⁴⁾ |
| Сплав 825 | ASTM B425 | ASTM B564, ASME SB564 |
| Сплав C-276 | ASTM B574 | ASTM B564 |
| Алюминий | ASTM B211 | ASTM B247 |
| Латунь | ASTM B16 ASTM B453 | ASTM B283 |
| Углеродистая сталь ⁽⁵⁾ | ASTM A108 | — |
| Дуплекс 2507 | ASTM A479 | ASTM A182 |
| Титан | ASTM B348 | ASTM B381 |
| Тефлон (PFA) | — | ASTM D3307 Type I |
| Тефлон (PTFE) | ASTM D1710 | ASTM D3294 |

- ① Прямые фитинги и переходники для трубок
- ② Отводы, крестовины и тройники
- ③ Все прямые фитинги и переходники для трубок диаметром 1/4 и 3/8 дюйма; Отводы, крестовины и тройники диаметром 6 и 10 мм.
- ④ Отводы, крестовины и тройники диаметром более 3/8 дюйма и 10 мм.
- ⑤ Все трубные фитинги CIR-LOK из углеродистой стали поставляются с задними обжимными кольцами из нержавеющей стали 316.

Спецификация по резьбам

| Тип резьбы | Справочная спецификация |
|--|-----------------------------------|
| NPT | ASME B1.20.1, SAE AS71051 |
| ISO/BSP(Цилиндрическая) (На основе DIN 3852) (Фитинги CIR-LOK PPT, BP и BS) | ISO 7-1, BS EN 10226-1, JIS B0203 |
| ISO/BSP(Коническая) (На основе DIN 3852) (Фитинги CIR-LOK BT) | ISO 228-1, JIS B0202 |
| Унифицированная (SAE) (CIR-LOK SA фитинги) | ASME B1.1 |
| Метрическая | ISO 261 |

Параметры рабочей температуры

| Материал | Рабочая температура, °F (°C) |
|---------------------------------|------------------------------|
| Нерж. ст. 316 | -321 (-196) до 1200 (649) |
| Латунь | -321 (-196) до 400 (204) |
| Углеродистая сталь | -65 (-53) до 375 (190) |
| Прокладки BS (FKM) | -5 (-15) до 400 (204) |
| Прокладки BG BP (медь) | -325 (-198) до 1200 (649) |
| Уплотнительные кольца SAE (FKM) | -20 (-28) до 400 (204) |

❖ Температура системы может быть ограничена герметиком для резьбы или, если применимо, материалом прокладки или уплотнительного кольца.

Герметики для трубной резьбы

❖ При сборке конической резьбы всегда следует использовать герметик резьбы или ленту из PTFE.

Метрические трубные фитинги CIR-LOK

❖ Метрические и дюймовые трубные фитинги внешне схожи. Во избежание путаницы и для облегчения идентификации трубные фитинги с метрической резьбой имеют ступенчатый выступ на шестиграннике корпуса и шестигранную гайку.

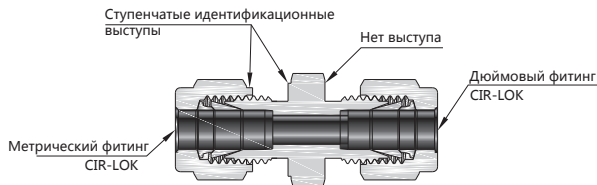

Параметры давления трубных фитингов CIR-LOK

❖ Концы трубных фитингов CIR-LOK рассчитаны на рабочее давление трубок, указанное в данных о трубках CIR-LOK.

Рабочее давление резьбы NPT/ISO

❖ Давление при комнатной температуре по стандарту ASME B31.3

| Размер трубы NPT/ISO | Нержавеющая и углеродистая сталь | | | | Латунь | | | |
|----------------------|----------------------------------|-----|---------------|-----|---------------|-----|---------------|-----|
| | Внешняя | | Внутренняя | | Внешняя | | Внутренняя | |
| | фунт/кв. дюйм | Бар | фунт/кв. дюйм | Бар | фунт/кв. дюйм | Бар | фунт/кв. дюйм | Бар |
| 1/16 | 11000 | 760 | 6700 | 460 | 5500 | 380 | 3300 | 230 |
| 1/8 | 10000 | 690 | 6500 | 440 | 5000 | 340 | 3200 | 220 |
| 1/4 | 8000 | 550 | 6600 | 450 | 4000 | 270 | 3300 | 220 |
| 3/8 | 7800 | 540 | 5300 | 360 | 3900 | 270 | 2600 | 180 |
| 1/2 | 7700 | 530 | 4900 | 330 | 3800 | 260 | 2400 | 160 |
| 3/4 | 7300 | 500 | 4600 | 320 | 3600 | 250 | 2300 | 160 |
| 1 | 5300 | 370 | 4400 | 300 | 2600 | 180 | 2200 | 150 |
| 1 1/4 | 6000 | 410 | 5000 | 350 | 3000 | 200 | 2500 | 170 |
| 1 1/2 | 5000 | 340 | 4600 | 310 | 2500 | 170 | 2300 | 150 |
| 2 | 3900 | 270 | 3900 | 270 | 1900 | 130 | 1900 | 130 |

Для уточнения давлений по стандарту ASME B31.1:
 Для нержавеющей стали коэффициент 0,94
 Для углеродистой стали коэффициент 0,85
 Для Латунни коэффициент остаётся тем же.

Унифицированная резьба SAE/MS

Рабочие давления по стандарту SAE J1926/3

| SAE/MS Размер резьбы | Нержавеющая и углеродистая сталь | | | |
|-------------------------|----------------------------------|-----|-----------------|-----|
| | Непозиционируемые | | Позиционируемые | |
| | фунт/кв. дюйм | Бар | фунт/кв. дюйм | Бар |
| 5/16-24 | 4568 | 315 | 4568 | 315 |
| 7/16-20 | | | | |
| 1/2-20 | | | | |
| 9/16-18 | | | 3626 | 250 |
| 3/4-16 | | | | |
| 7/8-14 | 3626 | 250 | 2900 | 200 |
| 1 1/16-12 | 2900 | 200 | 2320 | 160 |
| 1 3/16-12 | | | | |
| 1 5/16-12 | | | | |
| 1 5/8-12 | 2320 | 160 | 1813 | 125 |
| 1 7/8-12 | | | | |
| 2 1/2-12 | 1813 | 125 | 1450 | 100 |

Фитинги с уплотнительным кольцом из эластомеров имеют меньшие рабочие давления.

Позиционируемые, ISO/BSP Рабочее давление

Давления при комнатной температуре

| ISO/BSP Размер внешней трубы, дюйм | Нержавеющая и углеродистая сталь | |
|---|-------------------------------------|-----|
| | фунт/кв. дюйм | Бар |
| 1/8 | 4568 | 315 |
| 1/4 | | |
| 3/8 | | |
| 1/2 | 2320 | 160 |
| 3/4 | | |
| 1 | | |

Виды уплотнения цилиндрических резьб

1. Уплотнение комбинированной прокладкой

- Внешняя резьба по стандарту DIN 3852-2 тип A
- Внутренняя резьба по стандарту DIN 3852-2 тип X

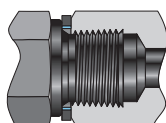

2. Уплотнение медной прокладкой

- Внешнее уплотнение по стандарту DIN 3852-2 тип B
- Внутреннее уплотнение по стандарту DIN 3852-2 тип X
- Медные прокладки используются только с фитингами типа BS.

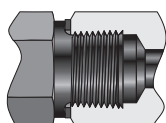

3. Уплотнение манометрических резьб медными кольцами

- Медные прокладки используются только с фитингами типа BS.

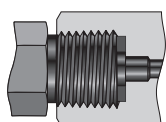

4. Уплотнение позиционируемой резьбы

- Внешнее уплотнение по стандарту DIN 3852-2 тип X

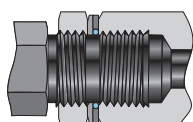

Штуцер с внешней резьбой

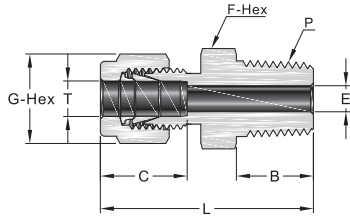

Дюймовая трубка

Резьба NPT

| Трубка, дюйм | Резьба P-NPT | Артикул для заказа | Размеры, мм | | | | | |
|--------------|--------------|--------------------|-------------|------|------|------|------|------|
| | | | L | B | C | E | G | F |
| 1/16 | 1/16 | F1-MC-NPT1- | 23.9 | 9.7 | 8.6 | 1.3 | 7.9 | 7.9 |
| 1/16 | 1/8 | F1-MC-NPT2- | 26.2 | 9.7 | 8.6 | 1.3 | 7.9 | 11.1 |
| 1/16 | 1/4 | F1-MC-NPT4- | 31.0 | 14.2 | 8.6 | 1.3 | 7.9 | 14.3 |
| 1/8 | 1/16 | F2-MC-NPT1- | 29.7 | 9.7 | 12.7 | 2.3 | 11.1 | 11.1 |
| 1/8 | 1/8 | F2-MC-NPT2- | 30.5 | 9.7 | 12.7 | 2.3 | 11.1 | 11.1 |
| 1/8 | 1/4 | F2-MC-NPT4- | 35.6 | 14.2 | 12.7 | 2.3 | 11.1 | 14.3 |
| 1/8 | 3/8 | F2-MC-NPT6- | 35.8 | 14.2 | 12.7 | 2.3 | 11.1 | 17.5 |
| 1/8 | 1/2 | F2-MC-NPT8- | 42.2 | 19.1 | 12.7 | 2.3 | 11.1 | 22.2 |
| 3/16 | 1/16 | F3-MC-NPT1- | 31.2 | 9.7 | 13.7 | 2.3 | 12.7 | 11.1 |
| 3/16 | 1/8 | F3-MC-NPT2- | 31.2 | 9.7 | 13.7 | 3.0 | 12.7 | 11.1 |
| 3/16 | 1/4 | F3-MC-NPT4- | 36.3 | 14.2 | 13.7 | 3.0 | 12.7 | 14.3 |
| 1/4 | 1/16 | F4-MC-NPT1- | 32.8 | 9.7 | 15.2 | 3.0 | 14.3 | 12.7 |
| 1/4 | 1/8 | F4-MC-NPT2- | 32.8 | 9.7 | 15.2 | 4.8 | 14.3 | 12.7 |
| 1/4 | 1/4 | F4-MC-NPT4- | 37.8 | 14.2 | 15.2 | 4.8 | 14.3 | 14.3 |
| 1/4 | 3/8 | F4-MC-NPT6- | 38.4 | 14.2 | 15.2 | 4.8 | 14.3 | 17.5 |
| 1/4 | 1/2 | F4-MC-NPT8- | 44.7 | 19.1 | 15.2 | 4.8 | 14.3 | 22.2 |
| 1/4 | 3/4 | F4-MC-NPT12- | 46.2 | 19.1 | 15.2 | 4.8 | 14.3 | 27.0 |
| 5/16 | 1/8 | F5-MC-NPT2- | 34.0 | 9.7 | 16.3 | 4.8 | 15.9 | 14.3 |
| 5/16 | 1/4 | F5-MC-NPT4- | 38.6 | 9.7 | 16.3 | 6.4 | 15.9 | 14.3 |
| 5/16 | 3/8 | F5-MC-NPT6- | 39.1 | 14.2 | 16.3 | 6.4 | 15.9 | 17.5 |
| 5/16 | 1/2 | F5-MC-NPT8- | 45.5 | 19.1 | 16.3 | 6.4 | 15.9 | 22.2 |
| 3/8 | 1/8 | F6-MC-NPT2- | 35.3 | 9.7 | 16.8 | 4.8 | 17.5 | 15.9 |
| 3/8 | 1/4 | F6-MC-NPT4- | 39.9 | 14.2 | 16.8 | 7.1 | 17.5 | 15.9 |
| 3/8 | 3/8 | F6-MC-NPT6- | 39.9 | 14.2 | 16.8 | 7.1 | 17.5 | 17.5 |
| 3/8 | 1/2 | F6-MC-NPT8- | 46.2 | 19.1 | 16.8 | 7.1 | 17.5 | 22.2 |
| 3/8 | 3/4 | F6-MC-NPT12- | 47.8 | 19.1 | 16.8 | 7.1 | 17.5 | 27.0 |
| 3/8 | 1 | F6-MC-NPT16- | 47.0 | 23.9 | 16.8 | 7.1 | 17.5 | 34.9 |
| 1/2 | 1/8 | F8-MC-NPT2- | 38.9 | 9.7 | 22.9 | 4.8 | 22.2 | 20.6 |
| 1/2 | 1/4 | F8-MC-NPT4- | 43.4 | 14.2 | 22.9 | 7.1 | 22.2 | 20.6 |
| 1/2 | 3/8 | F8-MC-NPT6- | 43.4 | 14.2 | 22.9 | 9.7 | 22.2 | 20.6 |
| 1/2 | 1/2 | F8-MC-NPT8- | 49.0 | 19.1 | 22.9 | 10.4 | 22.2 | 22.2 |
| 1/2 | 3/4 | F8-MC-NPT12- | 50.5 | 19.1 | 22.9 | 10.4 | 22.2 | 27.0 |
| 1/2 | 1 | F8-MC-NPT16- | 57.2 | 23.9 | 22.9 | 10.4 | 22.2 | 34.9 |
| 5/8 | 1/4 | F10-MC-NPT4- | 44.2 | 14.2 | 24.4 | 7.1 | 25.4 | 23.8 |
| 5/8 | 3/8 | F10-MC-NPT6- | 44.2 | 14.2 | 24.4 | 9.7 | 25.4 | 23.8 |
| 5/8 | 1/2 | F10-MC-NPT8- | 49.0 | 19.1 | 24.4 | 11.9 | 25.4 | 23.8 |
| 5/8 | 3/4 | F10-MC-NPT12- | 50.5 | 19.1 | 24.4 | 12.7 | 25.4 | 27.0 |
| 3/4 | 3/8 | F12-MC-NPT6- | 45.7 | 14.2 | 24.4 | 10.4 | 28.6 | 27.0 |
| 3/4 | 1/2 | F12-MC-NPT8- | 50.5 | 19.1 | 24.4 | 11.9 | 28.6 | 27.0 |
| 3/4 | 3/4 | F12-MC-NPT12- | 50.5 | 19.1 | 24.4 | 15.7 | 28.6 | 27.0 |
| 3/4 | 1 | F12-MC-NPT16- | 57.2 | 23.9 | 24.4 | 15.7 | 28.6 | 34.9 |
| 7/8 | 1/2 | F14-MC-NPT8- | 50.5 | 19.1 | 25.9 | 11.9 | 31.8 | 30.2 |
| 7/8 | 3/4 | F14-MC-NPT12- | 50.5 | 19.1 | 25.9 | 15.7 | 31.8 | 30.2 |
| 7/8 | 1 | F14-MC-NPT16- | 57.2 | 23.9 | 25.9 | 18.3 | 31.8 | 34.9 |
| 1 | 1/2 | F16-MC-NPT8- | 57.4 | 19.1 | 31.2 | 11.9 | 38.1 | 34.9 |
| 1 | 3/4 | F16-MC-NPT12- | 57.4 | 19.1 | 31.2 | 15.7 | 38.1 | 34.9 |
| 1 | 1 | F16-MC-NPT16- | 62.2 | 23.9 | 31.2 | 22.4 | 38.1 | 34.9 |
| 1 1/8 | 1 | F18-MC-NPT16- | 62.2 | 23.9 | 31.2 | 22.4 | 46.0 | 41.3 |
| 1 1/4 | 1 | F20-MC-NPT16- | 77.2 | 23.9 | 41.1 | 22.4 | 47.6 | 44.5 |
| 1 1/4 | 1 1/4 | F20-MC-NPT20- | 77.2 | 23.9 | 41.1 | 27.7 | 47.6 | 44.5 |
| 1 1/2 | 1 1/2 | F24-MC-NPT24- | 88.9 | 26.2 | 50.0 | 34.0 | 57.2 | 54.0 |

Штуцер с внешней резьбой

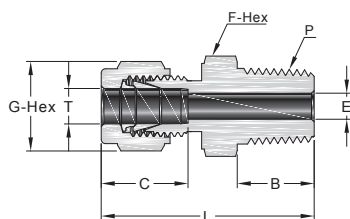

Метрическая трубка

Резьба NPT

| Трубка, мм | Р-NPT Резьба | Артикул для заказа | Размеры, мм | | | | | |
|------------|--------------|--------------------|-------------|------|------|------|----|----|
| | | | L | B | C | E | G | F |
| 2 | 1/8 | M2-MC-NPT2- | 30.5 | 9.7 | 12.9 | 1.7 | 12 | 12 |
| 3 | 1/8 | M3-MC-NPT2- | 30.5 | 9.7 | 12.9 | 2.4 | 12 | 12 |
| 3 | 1/4 | M3-MC-NPT4- | 35.6 | 14.2 | 12.9 | 2.4 | 12 | 14 |
| 4 | 1/8 | M4-MC-NPT2- | 31.2 | 9.7 | 13.7 | 2.4 | 12 | 12 |
| 4 | 1/4 | M4-MC-NPT4- | 36.3 | 14.2 | 13.7 | 2.4 | 12 | 14 |
| 6 | 1/8 | M6-MC-NPT2- | 32.8 | 9.7 | 15.3 | 4.8 | 14 | 14 |
| 6 | 1/4 | M6-MC-NPT4- | 37.9 | 14.2 | 15.3 | 4.8 | 14 | 14 |
| 6 | 3/8 | M6-MC-NPT6- | 38.4 | 14.2 | 15.3 | 4.8 | 14 | 18 |
| 6 | 1/2 | M6-MC-NPT8- | 44.7 | 19.1 | 15.3 | 4.8 | 14 | 22 |
| 8 | 1/8 | M8-MC-NPT2- | 34.2 | 9.7 | 16.2 | 4.8 | 16 | 15 |
| 8 | 1/4 | M8-MC-NPT4- | 38.7 | 14.2 | 16.2 | 6.4 | 16 | 15 |
| 8 | 3/8 | M8-MC-NPT6- | 39.3 | 14.2 | 16.2 | 6.4 | 16 | 18 |
| 8 | 1/2 | M8-MC-NPT8- | 45.6 | 19.1 | 16.2 | 6.4 | 16 | 22 |
| 10 | 1/8 | M10-MC-NPT2- | 36.3 | 9.7 | 17.2 | 4.8 | 19 | 18 |
| 10 | 1/4 | M10-MC-NPT4- | 40.9 | 14.2 | 17.2 | 7.1 | 19 | 18 |
| 10 | 3/8 | M10-MC-NPT6- | 40.9 | 14.2 | 17.2 | 7.9 | 19 | 18 |
| 10 | 1/2 | M10-MC-NPT8- | 46.5 | 19.1 | 17.2 | 7.9 | 19 | 22 |
| 10 | 3/4 | M10-MC-NPT12- | 48.0 | 19.1 | 17.2 | 7.9 | 19 | 27 |
| 10 | 1 | M10-MC-NPT16- | 54.6 | 23.9 | 17.2 | 7.9 | 19 | 35 |
| 12 | 1/8 | M12-MC-NPT2- | 38.8 | 9.7 | 22.8 | 4.8 | 22 | 22 |
| 12 | 1/4 | M12-MC-NPT4- | 43.4 | 14.2 | 22.8 | 7.1 | 22 | 22 |
| 12 | 3/8 | M12-MC-NPT6- | 43.4 | 14.2 | 22.8 | 9.5 | 22 | 22 |
| 12 | 1/2 | M12-MC-NPT8- | 49.0 | 19.1 | 22.8 | 9.5 | 22 | 22 |
| 12 | 3/4 | M12-MC-NPT12- | 50.5 | 19.1 | 22.8 | 9.5 | 22 | 27 |
| 14 | 1/8 | M14-MC-NPT2- | 38.8 | 9.7 | 24.4 | 4.8 | 25 | 24 |
| 14 | 1/4 | M14-MC-NPT4- | 44.1 | 14.2 | 24.4 | 7.1 | 25 | 24 |
| 14 | 3/8 | M14-MC-NPT6- | 44.1 | 14.2 | 24.4 | 9.5 | 25 | 24 |
| 14 | 1/2 | M14-MC-NPT8- | 49.0 | 19.1 | 24.4 | 11.1 | 25 | 24 |
| 14 | 3/4 | M14-MC-NPT12- | 50.5 | 19.1 | 24.4 | 11.1 | 25 | 27 |
| 15 | 1/2 | M15-MC-NPT8- | 49.0 | 19.1 | 24.4 | 11.9 | 25 | 24 |
| 15 | 3/4 | M15-MC-NPT12- | 50.5 | 19.1 | 24.4 | 11.9 | 25 | 27 |
| 15 | 1 | M15-MC-NPT16- | 57.1 | 23.9 | 24.4 | 11.9 | 25 | 35 |
| 16 | 1/4 | M16-MC-NPT4- | 44.1 | 14.2 | 24.4 | 7.1 | 25 | 24 |
| 16 | 3/8 | M16-MC-NPT6- | 44.1 | 14.2 | 24.4 | 9.5 | 25 | 24 |
| 16 | 1/2 | M16-MC-NPT8- | 49.0 | 19.1 | 24.4 | 11.9 | 25 | 24 |
| 16 | 3/4 | M16-MC-NPT12- | 50.5 | 19.1 | 24.4 | 12.7 | 25 | 27 |
| 18 | 3/8 | M18-MC-NPT6- | 45.6 | 14.2 | 24.4 | 9.5 | 30 | 27 |
| 18 | 1/2 | M18-MC-NPT8- | 50.5 | 19.1 | 24.4 | 11.9 | 30 | 27 |
| 18 | 3/4 | M18-MC-NPT12- | 50.5 | 19.1 | 24.4 | 15.1 | 30 | 27 |
| 20 | 1/2 | M20-MC-NPT8- | 52.3 | 19.1 | 26.0 | 11.9 | 32 | 30 |
| 20 | 3/4 | M20-MC-NPT12- | 52.3 | 19.1 | 26.0 | 15.9 | 32 | 30 |
| 20 | 1 | M20-MC-NPT16- | 57.1 | 23.9 | 26.0 | 15.9 | 32 | 35 |
| 22 | 1/2 | M22-MC-NPT8- | 52.3 | 19.1 | 26.0 | 11.9 | 32 | 30 |
| 22 | 3/4 | M22-MC-NPT12- | 52.3 | 19.1 | 26.0 | 15.9 | 32 | 30 |
| 22 | 1 | M22-MC-NPT16- | 57.1 | 23.9 | 26.0 | 18.3 | 32 | 35 |
| 25 | 1/2 | M25-MC-NPT8- | 57.5 | 19.1 | 31.3 | 11.9 | 38 | 35 |
| 25 | 3/4 | M25-MC-NPT12- | 57.5 | 19.1 | 31.3 | 15.9 | 38 | 35 |
| 25 | 1 | M25-MC-NPT16- | 62.3 | 23.9 | 31.3 | 21.8 | 38 | 35 |
| 28 | 1 | M28-MC-NPT16- | 72.4 | 23.9 | 36.6 | 21.8 | 46 | 41 |
| 28 | 1 1/4 | M28-MC-NPT20- | 73.1 | 23.9 | 36.6 | 21.8 | 46 | 46 |
| 30 | 1 1/4 | M30-MC-NPT20- | 77.2 | 23.9 | 39.6 | 26.2 | 50 | 46 |
| 32 | 1 1/4 | M32-MC-NPT20- | 79.6 | 23.9 | 42.0 | 28.6 | 50 | 46 |
| 38 | 1 1/2 | M38-MC-NPT24- | 91.6 | 26.2 | 49.4 | 33.7 | 60 | 55 |

Штуцер с внешней резьбой

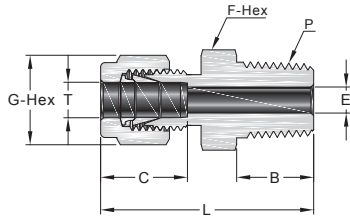

Дюймовая трубка

Коническая резьба ISO (BSPT)

| Трубка, дюйм | P-BSPT Резьба | Артикул для заказа | Размеры, мм | | | | | |
|--------------|---------------|--------------------|-------------|------|------|------|------|------|
| | | | L | B | C | E | G | F |
| 1/8 | 1/8 | F2-MC-MBT2- | 30.5 | 9.7 | 12.7 | 2.3 | 11.1 | 11.1 |
| 1/8 | 1/4 | F2-MC-MBT4- | 35.6 | 14.2 | 12.7 | 2.3 | 11.1 | 14.3 |
| 1/4 | 1/8 | F4-MC-MBT2- | 32.8 | 9.7 | 15.2 | 4.8 | 14.3 | 12.7 |
| 1/4 | 1/4 | F4-MC-MBT4- | 37.8 | 14.2 | 15.2 | 4.8 | 14.3 | 14.3 |
| 1/4 | 3/8 | F4-MC-MBT6- | 38.4 | 14.2 | 15.2 | 4.8 | 14.3 | 17.5 |
| 1/4 | 1/2 | F4-MC-MBT8- | 44.7 | 19.1 | 15.2 | 4.8 | 14.3 | 22.2 |
| 5/16 | 1/8 | F5-MC-MBT2- | 34.0 | 9.7 | 16.3 | 4.8 | 15.9 | 14.3 |
| 5/16 | 1/4 | F5-MC-MBT4- | 38.6 | 9.7 | 16.3 | 6.4 | 15.9 | 14.3 |
| 3/8 | 1/8 | F6-MC-MBT2- | 35.3 | 9.7 | 16.8 | 4.8 | 17.5 | 15.9 |
| 3/8 | 1/4 | F6-MC-MBT4- | 39.9 | 14.2 | 16.8 | 7.1 | 17.5 | 15.9 |
| 3/8 | 3/8 | F6-MC-MBT6- | 39.9 | 14.2 | 16.8 | 7.1 | 17.5 | 17.5 |
| 3/8 | 1/2 | F6-MC-MBT8- | 46.2 | 19.1 | 16.8 | 7.1 | 17.5 | 22.2 |
| 3/8 | 3/4 | F6-MC-MBT12- | 47.8 | 19.1 | 16.8 | 7.1 | 17.5 | 27.0 |
| 1/2 | 1/4 | F8-MC-MBT4- | 43.4 | 14.2 | 22.9 | 7.1 | 22.2 | 20.6 |
| 1/2 | 3/8 | F8-MC-MBT6- | 43.4 | 14.2 | 22.9 | 9.7 | 22.2 | 20.6 |
| 1/2 | 1/2 | F8-MC-MBT8- | 49.0 | 19.1 | 22.9 | 10.4 | 22.2 | 22.2 |
| 1/2 | 3/4 | F8-MC-MBT12- | 50.5 | 19.1 | 22.9 | 10.4 | 22.2 | 27.0 |
| 5/8 | 1/2 | F10-MC-MBT8- | 49.0 | 19.1 | 24.4 | 11.9 | 25.4 | 23.8 |
| 3/4 | 3/4 | F12-MC-MBT12- | 50.5 | 19.1 | 24.4 | 15.7 | 28.6 | 27.0 |
| 3/4 | 1 | F12-MC-MBT16- | 57.2 | 23.9 | 24.4 | 15.7 | 28.6 | 34.9 |
| 1 | 3/4 | F16-MC-MBT12- | 57.4 | 19.1 | 31.2 | 15.7 | 38.1 | 34.9 |
| 1 | 1 | F16-MC-MBT16- | 62.2 | 23.9 | 31.2 | 22.4 | 38.1 | 34.9 |

Штуцер с внешней резьбой

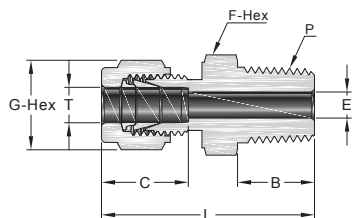

Метрическая трубка

Коническая резьба ISO (BSPT)

| Трубка, мм | P-BSPT Резьба | Артикул для заказа | Размеры, мм | | | | | |
|------------|---------------|--------------------|-------------|------|------|------|----|----|
| | | | L | B | C | E | G | F |
| 2 | 1/8 | M2-MC-MBT2- | 30.5 | 9.7 | 12.9 | 1.7 | 12 | 12 |
| 3 | 1/8 | M3-MC-MBT2- | 30.5 | 9.7 | 12.9 | 2.4 | 12 | 12 |
| 3 | 1/4 | M3-MC-MBT4- | 35.6 | 14.2 | 12.9 | 2.4 | 12 | 14 |
| 4 | 1/8 | M4-MC-MBT2- | 31.2 | 9.7 | 13.7 | 2.4 | 12 | 12 |
| 4 | 1/4 | M4-MC-MBT4- | 36.3 | 14.2 | 13.7 | 2.4 | 12 | 14 |
| 6 | 1/8 | M6-MC-MBT2- | 32.8 | 9.7 | 15.3 | 4.8 | 14 | 14 |
| 6 | 1/4 | M6-MC-MBT4- | 37.9 | 14.2 | 15.3 | 4.8 | 14 | 14 |
| 6 | 3/8 | M6-MC-MBT6- | 38.4 | 14.2 | 15.3 | 4.8 | 14 | 18 |
| 6 | 1/2 | M6-MC-MBT8- | 44.7 | 19.1 | 15.3 | 4.8 | 14 | 22 |
| 8 | 1/8 | M8-MC-MBT2- | 34.2 | 9.7 | 16.2 | 4.8 | 16 | 15 |
| 8 | 1/4 | M8-MC-MBT4- | 38.7 | 14.2 | 16.2 | 6.4 | 16 | 15 |
| 8 | 3/8 | M8-MC-MBT6- | 39.2 | 14.2 | 16.2 | 6.4 | 16 | 18 |
| 8 | 1/2 | M8-MC-MBT8- | 45.6 | 19.1 | 16.2 | 6.4 | 16 | 22 |
| 10 | 1/8 | M10-MC-MBT2- | 36.3 | 9.7 | 17.2 | 4.8 | 19 | 18 |
| 10 | 1/4 | M10-MC-MBT4- | 40.9 | 14.2 | 17.2 | 7.1 | 19 | 18 |
| 10 | 3/8 | M10-MC-MBT6- | 40.9 | 14.2 | 17.2 | 7.9 | 19 | 18 |
| 10 | 1/2 | M10-MC-MBT8- | 46.5 | 19.1 | 17.2 | 7.9 | 19 | 22 |
| 10 | 3/4 | M10-MC-MBT12- | 48.0 | 19.1 | 17.2 | 7.9 | 19 | 27 |
| 12 | 1/8 | M12-MC-MBT2- | 38.3 | 9.7 | 22.8 | 4.8 | 22 | 22 |
| 12 | 1/4 | M12-MC-MBT4- | 43.4 | 14.2 | 22.8 | 7.1 | 22 | 22 |
| 12 | 3/8 | M12-MC-MBT6- | 43.4 | 14.2 | 22.8 | 9.5 | 22 | 22 |
| 12 | 1/2 | M12-MC-MBT8- | 49.0 | 19.1 | 22.8 | 9.5 | 22 | 22 |
| 12 | 3/4 | M12-MC-MBT12- | 50.5 | 19.1 | 22.8 | 9.5 | 22 | 27 |
| 14 | 1/8 | M14-MC-MBT2- | 38.8 | 9.7 | 24.4 | 4.8 | 25 | 24 |
| 14 | 1/4 | M14-MC-MBT4- | 44.1 | 14.2 | 24.4 | 7.1 | 25 | 24 |
| 14 | 3/8 | M14-MC-MBT6- | 44.1 | 14.2 | 24.4 | 7.9 | 25 | 24 |
| 14 | 1/2 | M14-MC-MBT8- | 49.0 | 19.1 | 24.4 | 11.1 | 25 | 24 |
| 14 | 3/4 | M14-MC-MBT12- | 50.5 | 19.1 | 24.4 | 11.1 | 25 | 27 |
| 15 | 1/2 | M15-MC-MBT8- | 49.0 | 19.1 | 24.4 | 11.9 | 25 | 24 |
| 16 | 1/4 | M16-MC-MBT4- | 44.1 | 14.2 | 24.4 | 7.1 | 25 | 24 |
| 16 | 3/8 | M16-MC-MBT6- | 44.1 | 14.2 | 24.4 | 9.5 | 25 | 24 |
| 16 | 1/2 | M16-MC-MBT8- | 49.0 | 19.1 | 24.4 | 11.9 | 25 | 24 |
| 16 | 3/4 | M16-MC-MBT12- | 50.5 | 19.1 | 24.4 | 12.7 | 25 | 27 |
| 18 | 1/2 | M18-MC-MBT8- | 50.5 | 19.1 | 24.4 | 11.9 | 30 | 27 |
| 18 | 3/4 | M18-MC-MBT12- | 50.5 | 19.1 | 24.4 | 15.1 | 30 | 27 |
| 20 | 1/2 | M20-MC-MBT8- | 52.3 | 19.1 | 26.0 | 11.9 | 32 | 30 |
| 20 | 3/4 | M20-MC-MBT12- | 52.3 | 19.1 | 26.0 | 15.9 | 32 | 30 |
| 22 | 3/4 | M22-MC-MBT12- | 52.3 | 19.1 | 26.0 | 15.9 | 32 | 30 |
| 22 | 1 | M22-MC-MBT16- | 57.1 | 23.9 | 26.0 | 18.3 | 32 | 35 |
| 25 | 1/2 | M25-MC-MBT8- | 57.5 | 19.1 | 31.3 | 11.9 | 38 | 35 |
| 25 | 3/4 | M25-MC-MBT12- | 57.5 | 19.1 | 31.3 | 15.9 | 38 | 35 |
| 25 | 1 | M25-MC-MBT16- | 62.3 | 23.9 | 31.3 | 21.8 | 38 | 35 |
| 28 | 1 | M28-MC-MBT16- | 72.4 | 23.9 | 36.6 | 21.8 | 46 | 41 |
| 28 | 1 1/4 | M28-MC-MBT20- | 73.1 | 23.9 | 36.6 | 21.8 | 46 | 46 |
| 30 | 1 1/4 | M30-MC-MBT20- | 77.2 | 23.9 | 39.6 | 26.2 | 50 | 46 |
| 32 | 1 1/4 | M32-MC-MBT20- | 79.6 | 23.9 | 42.0 | 28.6 | 50 | 46 |
| 38 | 1 1/2 | M38-MC-MBT24- | 91.6 | 26.2 | 49.4 | 33.7 | 60 | 55 |

Штуцер с внешней резьбой

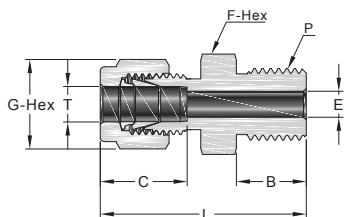

Дюймовая трубка

ISO Цилиндрическая резьба (BG)

| Трубка, дюйм | P-BG Резьба | Артикул для заказа | Размеры, мм | | | | | |
|--------------|-------------|--------------------|-------------|------|------|-----|------|------|
| | | | L | B | C | E | G | F |
| 1/4 | 3/8 | F4-MC-MBP6- | 38.4 | 14.2 | 15.2 | 4.8 | 14.3 | 17.5 |
| 3/8 | 3/8 | F6-MC-MBP6- | 39.9 | 14.2 | 16.8 | 7.1 | 17.5 | 17.5 |

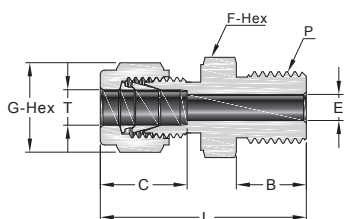

Метрическая трубка

ISO Цилиндрическая резьба (BG)

| Трубка, мм | P-BG Резьба | Артикул для заказа | Размеры, мм | | | | | |
|------------|-------------|--------------------|-------------|------|------|-----|----|----|
| | | | L | B | C | E | G | F |
| 6 | 1/4 | M6-MC-MBP4- | 36.9 | 12.9 | 15.3 | 4.8 | 14 | 14 |
| 6 | 3/8 | M6-MC-MBP6- | 39.5 | 14.2 | 15.3 | 4.8 | 14 | 18 |
| 8 | 1/8 | M8-MC-MBP2- | 33.9 | 9.8 | 16.2 | 4.0 | 16 | 14 |
| 8 | 1/4 | M8-MC-MBP4- | 37.0 | 12.9 | 16.2 | 6.4 | 16 | 14 |
| 8 | 3/8 | M8-MC-MBP6- | 39.3 | 14.2 | 16.2 | 6.4 | 16 | 18 |
| 8 | 1/2 | M8-MC-MBP8- | 45.4 | 18.8 | 16.2 | 6.4 | 16 | 22 |
| 10 | 1/4 | M10-MC-MBP4- | 39.5 | 12.9 | 17.2 | 5.9 | 19 | 18 |
| 10 | 1/2 | M10-MC-MBP8- | 46.3 | 18.8 | 17.2 | 7.9 | 19 | 22 |
| 12 | 3/8 | M12-MC-MBP6- | 44.2 | 14.2 | 22.8 | 7.9 | 22 | 22 |
| 12 | 1/2 | M12-MC-MBP8- | 49.0 | 18.8 | 22.8 | 9.5 | 22 | 22 |
| 14 | 1/4 | M14-MC-MBP4- | 42.9 | 12.9 | 24.4 | 5.9 | 25 | 24 |
| 16 | 3/8 | M16-MC-MBP6- | 43.4 | 14.2 | 24.4 | 7.9 | 25 | 24 |
| 16 | 1/2 | M16-MC-MBP8- | 47.9 | 18.8 | 24.4 | 9.5 | 25 | 24 |
| 18 | 1/2 | M18-MC-MBP8- | 49.8 | 18.8 | 24.4 | 9.5 | 30 | 27 |

Штуцер с внешней резьбой

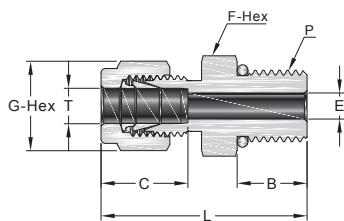

Адаптер по стандартам SAE J1926-1, ISO 11926-1 и MS 16142.

Дюймовая трубка

Прямая резьба SAE/MS с уплотнением

| Трубка, дюйм | P-SAE/MS Размер резьбы | Артикул для заказа | Размеры, мм | | | | | |
|--------------|------------------------------|-----------------------|-------------|------|------|------|------|------|
| | | | L | B | C | E | G | F |
| 1/16 | 5/16-24 | F1-MC-OST5- | 23.4 | 7.6 | 8.6 | 1.3 | 7.9 | 11.1 |
| 1/8 | 5/16-24 | F2-MC-OST5- | 30.0 | 7.6 | 12.7 | 2.3 | 11.1 | 11.1 |
| 1/8 | 7/16-20 | F2-MC-OST7- | 31.5 | 9.1 | 12.7 | 2.3 | 11.1 | 14.3 |
| 1/8 | 9/16-18 | F2-MC-OST9- | 33.3 | 9.9 | 12.7 | 2.3 | 11.1 | 17.5 |
| 3/16 | 3/8-24 | F3-MC-OST6- | 30.5 | 7.6 | 13.7 | 3.0 | 12.7 | 12.7 |
| 1/4 | 5/16-24 | F4-MC-OST5- | 32.3 | 7.6 | 15.2 | 2.3 | 14.3 | 12.7 |
| 1/4 | 7/16-20 | F4-MC-OST7- | 34.0 | 9.1 | 15.2 | 4.8 | 14.3 | 14.3 |
| 1/4 | 9/16-18 | F4-MC-OST9- | 35.6 | 9.9 | 15.2 | 4.8 | 14.3 | 17.5 |
| 1/4 | 3/4-16 | F4-MC-OST12- | 37.6 | 11.2 | 15.2 | 4.8 | 14.3 | 22.2 |
| 1/4 | 7/8-14 | F4-MC-OST14- | 40.6 | 12.7 | 15.2 | 4.8 | 15.9 | 25.4 |
| 5/16 | 1/2-20 | F5-MC-OST8- | 34.8 | 9.1 | 16.3 | 6.4 | 17.5 | 15.9 |
| 3/8 | 7/16-20 | F6-MC-OST7- | 35.6 | 9.1 | 16.8 | 5.1 | 17.5 | 15.9 |
| 3/8 | 9/16-18 | F6-MC-OST9- | 37.1 | 9.9 | 16.8 | 7.1 | 17.5 | 17.5 |
| 3/8 | 3/4-16 | F6-MC-OST12- | 39.1 | 11.2 | 16.8 | 7.1 | 17.5 | 22.2 |
| 3/8 | 7/8-14 | F6-MC-OST14- | 42.2 | 12.7 | 22.9 | 7.1 | 17.5 | 25.4 |
| 1/2 | 9/16-18 | F8-MC-OST9- | 39.1 | 9.9 | 22.9 | 7.1 | 22.2 | 20.6 |
| 1/2 | 3/4-16 | F8-MC-OST12- | 41.9 | 11.2 | 22.9 | 10.4 | 22.2 | 22.2 |
| 1/2 | 7/8-14 | F8-MC-OST14- | 45.0 | 12.7 | 22.9 | 10.4 | 22.2 | 25.4 |
| 1/2 | 1 1/16-12 | F8-MC-OST17- | 49.0 | 15.0 | 22.9 | 10.4 | 22.2 | 31.8 |
| 5/8 | 3/4-16 | F10-MC-OST12- | 41.9 | 11.2 | 24.4 | 10.7 | 25.4 | 23.8 |
| 5/8 | 7/8-14 | F10-MC-OST14- | 45.2 | 12.7 | 24.4 | 12.7 | 25.4 | 25.4 |
| 3/4 | 3/4-16 | F12-MC-OST12- | 46.0 | 11.2 | 24.4 | 10.7 | 28.6 | 27.0 |
| 3/4 | 1 1/16-12 | F12-MC-OST17- | 49.0 | 15.0 | 24.4 | 15.7 | 28.6 | 31.8 |
| 3/4 | 1 5/16-12 | F12-MC-OST21- | 49.8 | 15.0 | 24.4 | 16.0 | 28.6 | 38.1 |
| 7/8 | 1 3/16-12 | F14-MC-OST19- | 49.0 | 15.0 | 25.9 | 18.3 | 31.8 | 34.9 |
| 1 | 1 1/16-12 | F16-MC-OST17- | 53.3 | 15.0 | 31.2 | 16.8 | 38.1 | 34.9 |
| 1 | 1 5/16-12 | F16-MC-OST21- | 54.4 | 15.0 | 31.2 | 22.4 | 38.1 | 38.1 |
| 1 1/4 | 1 5/8-12 | F20-MC-OST26- | 68.3 | 15.0 | 41.1 | 27.7 | 47.6 | 47.6 |
| 1 1/2 | 1 7/8-12 | F24-MC-OST30- | 77.7 | 15.0 | 50.0 | 34.0 | 57.2 | 54.0 |

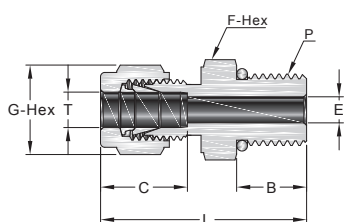

Адаптер по стандартам SAE J1926-1, ISO 11926-1 и MS 16142.

Метрическая трубка

Цилиндрическая резьба SAE/MS

| Трубка, мм | P-SAE/MS Размер резьбы | Артикул для заказа | Размеры, мм | | | | | |
|------------|------------------------------|-----------------------|-------------|------|------|-----|----|----|
| | | | L | B | C | E | G | F |
| 6 | 9/16-18 | M6-MC-OST9- | 35.6 | 9.9 | 15.3 | 4.8 | 14 | 18 |
| 10 | 9/16-18 | M10-MC-OST9- | 37.3 | 9.9 | 17.2 | 7.1 | 19 | 22 |
| 10 | 3/4-16 | M10-MC-OST12- | 39.4 | 11.2 | 17.2 | 7.9 | 19 | 22 |
| 12 | 7/16-20 | M12-MC-OST7- | 40.6 | 9.1 | 22.8 | 5.2 | 22 | 22 |
| 12 | 9/16-18 | M12-MC-OST9- | 39.9 | 9.9 | 22.8 | 7.1 | 22 | 22 |

Штуцер с внешней резьбой

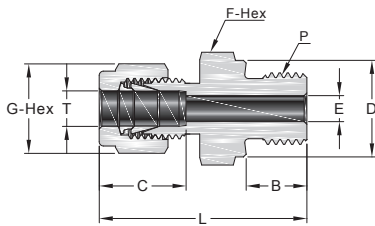

Дюймовая трубка

Цилиндрическая резьба ISO (BP)

| Трубка, дюйм | P-ВР Резьба | Артикул для заказа | Размеры, мм | | | | | | |
|--------------|-------------|--------------------|-------------|------|------|------|------|------|------|
| | | | L | B | C | E | G | F | D |
| 1/8 | 1/8 | F2-MC-PMBP2- | 30.0 | 7.1 | 12.7 | 2.3 | 11.1 | 14.3 | 13.7 |
| 1/8 | 1/4 | F2-MC-PMBP4- | 35.3 | 11.2 | 12.7 | 2.3 | 11.1 | 19.1 | 18.0 |
| 1/4 | 1/8 | F4-MC-PMBP2- | 32.3 | 7.1 | 15.2 | 4.1 | 14.3 | 14.3 | 13.8 |
| 1/4 | 1/4 | F4-MC-PMBP4- | 37.6 | 11.2 | 15.2 | 4.8 | 14.3 | 19.1 | 18.0 |
| 1/2 | 3/8 | F8-MC-PMBP6- | 40.4 | 11.2 | 22.9 | 7.9 | 22.2 | 22.2 | 21.8 |
| 1/2 | 1/2 | F8-MC-PMBP8- | 49.0 | 14.2 | 22.9 | 10.4 | 22.2 | 27.0 | 25.9 |
| 3/4 | 1/2 | F12-MC-PMBP8- | 49.0 | 14.2 | 24.4 | 11.9 | 28.6 | 27.0 | 25.9 |
| 3/4 | 3/4 | F12-MC-PMBP12- | 52.9 | 15.7 | 24.4 | 15.7 | 28.6 | 33.3 | 32 |
| 1 | 1 | F16-MC-PMBP16- | 59.9 | 18.3 | 31.2 | 19.8 | 38.1 | 41.3 | 39.1 |

Штуцер с внешней резьбой

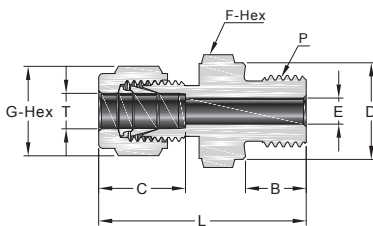

Метрическая трубка

Цилиндрическая резьба ISO (BP)

| Трубка, мм | P-ВР Резьба | Артикул для заказа | Размеры, мм | | | | | | |
|------------|-------------|--------------------|-------------|------|------|------|----|----|------|
| | | | L | B | C | E | G | F | D |
| 3 | 1/8 | M3-MC-PMBP2- | 30.0 | 7.1 | 12.9 | 2.4 | 12 | 14 | 13.8 |
| 3 | 1/4 | M3-MC-PMBP4- | 35.3 | 11.2 | 12.9 | 2.4 | 12 | 19 | 18.0 |
| 4 | 1/8 | M4-MC-PMBP2- | 30.7 | 7.1 | 13.7 | 2.4 | 12 | 14 | 13.8 |
| 6 | 1/8 | M6-MC-PMBP2- | 32.3 | 7.1 | 15.3 | 4.0 | 14 | 14 | 13.8 |
| 6 | 1/4 | M6-MC-PMBP4- | 37.6 | 11.2 | 15.3 | 4.8 | 14 | 19 | 18.0 |
| 6 | 3/8 | M6-MC-PMBP6- | 38.9 | 11.2 | 15.3 | 4.8 | 14 | 22 | 21.8 |
| 6 | 1/2 | M6-MC-PMBP8- | 44.7 | 14.2 | 15.3 | 4.8 | 14 | 27 | 26.0 |
| 8 | 1/8 | M8-MC-PMBP2- | 33.3 | 7.1 | 16.2 | 4.0 | 16 | 15 | 13.8 |
| 8 | 1/4 | M8-MC-PMBP4- | 38.5 | 11.2 | 16.2 | 5.9 | 16 | 19 | 18.0 |
| 8 | 3/8 | M8-MC-PMBP6- | 39.8 | 11.2 | 16.2 | 6.4 | 16 | 22 | 21.8 |
| 8 | 1/2 | M8-MC-PMBP8- | 45.6 | 14.2 | 16.2 | 6.4 | 16 | 27 | 26.0 |
| 10 | 1/4 | M10-MC-PMBP4- | 39.4 | 11.2 | 17.2 | 5.9 | 19 | 19 | 18.0 |
| 10 | 3/8 | M10-MC-PMBP6- | 40.6 | 11.2 | 17.2 | 7.9 | 19 | 22 | 21.8 |
| 10 | 1/2 | M10-MC-PMBP8- | 46.5 | 14.2 | 17.2 | 7.9 | 19 | 27 | 26.0 |
| 12 | 1/4 | M12-MC-PMBP4- | 42.6 | 11.2 | 22.8 | 5.9 | 22 | 22 | 18.0 |
| 12 | 3/8 | M12-MC-PMBP6- | 43.1 | 11.2 | 22.8 | 7.9 | 22 | 22 | 21.8 |
| 12 | 1/2 | M12-MC-PMBP8- | 49.0 | 14.2 | 22.8 | 9.5 | 22 | 27 | 26.0 |
| 12 | 3/4 | M12-MC-PMBP12- | 52.8 | 15.7 | 22.8 | 9.5 | 22 | 35 | 32.0 |
| 15 | 1/2 | M15-MC-PMBP8- | 49.0 | 14.2 | 24.4 | 11.9 | 25 | 27 | 26.0 |
| 16 | 3/8 | M16-MC-PMBP6- | 43.9 | 11.2 | 24.4 | 7.9 | 25 | 24 | 21.8 |
| 16 | 1/2 | M16-MC-PMBP8- | 49.0 | 14.2 | 24.4 | 11.9 | 25 | 27 | 26.0 |
| 18 | 1/2 | M18-MC-PMBP8- | 49.0 | 14.2 | 24.4 | 11.9 | 30 | 27 | 26.0 |
| 18 | 3/4 | M18-MC-PMBP12- | 52.8 | 15.7 | 24.4 | 15.1 | 30 | 35 | 32.0 |
| 20 | 1/2 | M20-MC-PMBP8- | 50.5 | 14.2 | 26.0 | 11.9 | 32 | 30 | 26.0 |
| 20 | 3/4 | M20-MC-PMBP12- | 52.8 | 15.7 | 26.0 | 15.9 | 32 | 35 | 32.0 |
| 22 | 3/4 | M22-MC-PMBP12- | 52.8 | 15.7 | 26.0 | 15.9 | 32 | 35 | 32.0 |
| 22 | 1 | M22-MC-PMBP16- | 55.3 | 18.3 | 26.0 | 18.3 | 32 | 41 | 39.0 |
| 25 | 3/4 | M25-MC-PMBP12- | 57.5 | 15.7 | 31.3 | 15.9 | 38 | 35 | 32.0 |
| 25 | 1 | M25-MC-PMBP16- | 60.1 | 18.3 | 31.3 | 19.8 | 38 | 41 | 39.0 |
| 28 | 1 | M28-MC-PMBP16- | 70.1 | 18.3 | 36.6 | 19.8 | 46 | 41 | 39.0 |
| 28 | 1 1/4 | M28-MC-PMBP20- | 73.9 | 19.8 | 36.6 | 21.8 | 46 | 50 | 49.0 |
| 30 | 1 1/4 | M30-MC-PMBP20- | 76.5 | 19.8 | 39.6 | 26.2 | 50 | 50 | 49.0 |
| 32 | 1 1/4 | M32-MC-PMBP20- | 78.9 | 19.8 | 42.0 | 28.6 | 50 | 50 | 49.0 |
| 38 | 1 1/2 | M38-MC-PMBP24- | 89.3 | 20.6 | 49.4 | 31.8 | 60 | 55 | 54.7 |

Штуцер с внешней резьбой

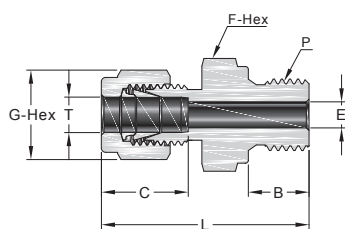

Дюймовая трубка

Цилиндрическая резьба ISO (BS)

| Трубка, дюйм | P-BS Резьба | Артикул для заказа | Размеры, мм | | | | | | |
|--------------|-------------|--------------------|-------------|------|------|------|------|------|------|
| | | | L | B | C | E | G | F | D |
| 1/8 | 1/8 | F2-MC-MBS2- | 30.0 | 7.1 | 12.7 | 2.3 | 11.1 | 14.3 | 13.7 |
| 1/8 | 1/4 | F2-MC-MBS4- | 35.3 | 11.2 | 12.7 | 2.3 | 11.1 | 19.1 | 18.0 |
| 1/8 | 3/8 | F2-MC-MBS6- | 36.3 | 11.2 | 12.7 | 2.3 | 11.1 | 22.2 | 21.8 |
| 1/4 | 1/8 | F4-MC-MBS2- | 32.3 | 7.1 | 15.2 | 4.0 | 14.3 | 14.3 | 13.7 |
| 1/4 | 1/4 | F4-MC-MBS4- | 37.6 | 11.2 | 15.2 | 4.8 | 14.3 | 19.1 | 18.0 |
| 1/4 | 3/8 | F4-MC-MBS6- | 38.9 | 11.2 | 15.2 | 4.8 | 14.3 | 22.2 | 21.8 |
| 1/4 | 1/2 | F4-MC-MBS8- | 44.7 | 14.2 | 15.2 | 4.8 | 14.3 | 27.0 | 25.9 |
| 3/8 | 1/8 | F6-MC-MBS2- | 37.8 | 7.1 | 16.8 | 4.0 | 17.5 | 15.9 | 13.7 |
| 3/8 | 1/4 | F6-MC-MBS4- | 39.1 | 11.2 | 16.8 | 5.9 | 17.5 | 19.1 | 18.0 |
| 3/8 | 3/8 | F6-MC-MBS6- | 40.4 | 11.2 | 16.8 | 7.1 | 17.5 | 22.2 | 21.8 |
| 3/8 | 1/2 | F6-MC-MBS8- | 46.2 | 14.2 | 16.8 | 7.1 | 17.5 | 27.0 | 25.9 |
| 1/2 | 1/4 | F8-MC-MBS4- | 42.7 | 11.2 | 22.9 | 5.9 | 22.2 | 20.6 | 18.0 |
| 1/2 | 3/8 | F8-MC-MBS6- | 43.2 | 11.2 | 22.9 | 7.9 | 22.2 | 22.2 | 21.8 |
| 1/2 | 1/2 | F8-MC-MBS8- | 49.0 | 14.2 | 22.9 | 10.4 | 22.2 | 27.0 | 25.9 |
| 3/4 | 1/2 | F12-MC-MBS8- | 49.0 | 14.2 | 24.4 | 11.9 | 28.6 | 27.0 | 25.9 |
| 3/4 | 3/4 | F12-MC-MBS12- | 52.9 | 15.7 | 24.4 | 15.7 | 28.6 | 33.3 | 32.0 |
| 1 | 1/2 | F16-MC-MBS8- | 55.5 | 14.2 | 31.2 | 11.9 | 38.1 | 34.9 | 25.9 |
| 1 | 3/4 | F16-MC-MBS12- | 57.7 | 15.7 | 31.2 | 16.0 | 38.1 | 34.9 | 32.0 |
| 1 | 1 | F16-MC-MBS16- | 59.9 | 18.3 | 31.2 | 19.8 | 38.1 | 41.3 | 39.1 |

Штуцер с внешней резьбой

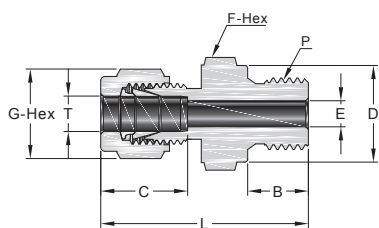

Метрическая трубка

Цилиндрическая резьба ISO (BS)

| Трубка, мм | P-BS Резьба | Артикул для заказа | Размеры, мм | | | | | | |
|------------|-------------|--------------------|-------------|------|------|------|----|----|------|
| | | | L | B | C | E | G | F | D |
| 2 | 1/8 | M2-MC-MBS2- | 30.0 | 7.1 | 12.9 | 1.7 | 12 | 14 | 13.7 |
| 3 | 1/8 | M3-MC-MBS2- | 30.0 | 7.1 | 12.9 | 2.4 | 12 | 14 | 13.7 |
| 3 | 1/4 | M3-MC-MBS4- | 35.3 | 11.2 | 12.9 | 2.4 | 12 | 19 | 18.0 |
| 4 | 1/8 | M4-MC-MBS2- | 30.7 | 7.1 | 13.7 | 2.4 | 12 | 14 | 13.7 |
| 4 | 1/4 | M4-MC-MBS4- | 36.0 | 11.2 | 13.7 | 2.4 | 12 | 19 | 18.0 |
| 6 | 1/8 | M6-MC-MBS2- | 32.3 | 7.1 | 15.3 | 4.0 | 14 | 14 | 13.7 |
| 6 | 1/4 | M6-MC-MBS4- | 37.6 | 11.2 | 15.3 | 4.8 | 14 | 19 | 18.0 |
| 6 | 3/8 | M6-MC-MBS6- | 38.9 | 11.2 | 15.3 | 4.8 | 14 | 22 | 21.6 |
| 6 | 1/2 | M6-MC-MBS8- | 44.7 | 14.2 | 15.3 | 4.8 | 14 | 27 | 25.9 |
| 8 | 1/8 | M8-MC-MBS2- | 33.2 | 7.1 | 16.2 | 4.0 | 16 | 15 | 14.5 |
| 8 | 1/4 | M8-MC-MBS4- | 38.5 | 11.2 | 16.2 | 6.4 | 16 | 19 | 18.0 |
| 8 | 3/8 | M8-MC-MBS6- | 39.8 | 11.2 | 16.2 | 6.4 | 16 | 22 | 21.6 |
| 8 | 1/2 | M8-MC-MBS8- | 45.6 | 14.2 | 16.2 | 6.4 | 16 | 27 | 25.9 |
| 8 | 3/4 | M8-MC-MBS12- | 49.5 | 15.7 | 16.2 | 6.4 | 16 | 35 | 32.0 |
| 10 | 1/4 | M10-MC-MBS4- | 39.4 | 11.2 | 17.2 | 5.9 | 19 | 19 | 18.0 |
| 10 | 3/8 | M10-MC-MBS6- | 40.6 | 11.2 | 17.2 | 7.9 | 19 | 22 | 21.6 |
| 10 | 1/2 | M10-MC-MBS8- | 46.5 | 14.2 | 17.2 | 7.9 | 19 | 27 | 25.9 |
| 12 | 1/4 | M12-MC-MBS4- | 42.6 | 11.2 | 22.8 | 5.9 | 22 | 22 | 21.6 |
| 12 | 3/8 | M12-MC-MBS6- | 43.1 | 11.2 | 22.8 | 7.9 | 22 | 22 | 21.6 |
| 12 | 1/2 | M12-MC-MBS8- | 49.0 | 14.2 | 22.8 | 9.5 | 22 | 27 | 25.9 |
| 12 | 3/4 | M12-MC-MBS12- | 52.8 | 15.7 | 22.8 | 9.5 | 22 | 35 | 32.0 |
| 14 | 1/4 | M14-MC-MBS4- | 42.9 | 11.2 | 24.4 | 7.1 | 25 | 24 | 18.0 |
| 14 | 3/8 | M14-MC-MBS6- | 43.9 | 11.2 | 24.4 | 7.9 | 25 | 24 | 21.6 |
| 14 | 1/2 | M14-MC-MBS8- | 49.0 | 14.2 | 24.4 | 11.1 | 25 | 27 | 25.9 |
| 14 | 3/4 | M14-MC-MBS12- | 52.8 | 15.7 | 24.4 | 11.1 | 25 | 35 | 32.0 |
| 15 | 3/8 | M15-MC-MBS6- | 43.9 | 11.2 | 24.4 | 7.9 | 25 | 24 | 21.6 |
| 15 | 1/2 | M15-MC-MBS8- | 49.0 | 14.2 | 24.4 | 11.9 | 25 | 27 | 25.9 |
| 15 | 3/4 | M15-MC-MBS12- | 52.8 | 15.7 | 24.4 | 11.9 | 25 | 35 | 32.0 |
| 16 | 3/8 | M16-MC-MBS6- | 43.9 | 11.2 | 24.4 | 7.9 | 25 | 24 | 21.6 |
| 16 | 1/2 | M16-MC-MBS8- | 49.0 | 14.2 | 24.4 | 11.9 | 25 | 27 | 25.9 |
| 16 | 3/4 | M16-MC-MBS12- | 52.8 | 15.7 | 24.4 | 12.7 | 25 | 35 | 32.0 |
| 18 | 1/2 | M18-MC-MBS8- | 49.0 | 14.2 | 24.4 | 11.9 | 30 | 27 | 25.9 |
| 18 | 3/4 | M18-MC-MBS12- | 52.8 | 15.7 | 24.4 | 15.1 | 30 | 35 | 32.0 |
| 20 | 1/2 | M20-MC-MBS8- | 50.5 | 14.2 | 26.0 | 11.9 | 32 | 30 | 25.9 |
| 20 | 3/4 | M20-MC-MBS12- | 52.8 | 15.7 | 26.0 | 15.9 | 32 | 35 | 32.0 |
| 22 | 3/4 | M22-MC-MBS12- | 52.8 | 15.7 | 26.0 | 15.9 | 32 | 35 | 32.0 |
| 22 | 1 | M22-MC-MBS16- | 55.3 | 18.3 | 26.0 | 18.3 | 32 | 41 | 39.1 |
| 25 | 3/4 | M25-MC-MBS12- | 57.5 | 15.7 | 31.3 | 15.9 | 38 | 35 | 32.0 |
| 25 | 1 | M25-MC-MBS16- | 60.1 | 18.3 | 31.3 | 19.8 | 38 | 41 | 39.1 |
| 28 | 1 | M28-MC-MBS16- | 70.1 | 18.3 | 36.6 | 19.8 | 46 | 41 | 39.1 |
| 28 | 1 1/4 | M28-MC-MBS20- | 73.9 | 19.8 | 36.6 | 21.8 | 46 | 50 | 49.0 |
| 30 | 1 1/4 | M30-MC-MBS20- | 76.5 | 19.8 | 39.6 | 25.0 | 50 | 50 | 49.0 |
| 32 | 1 1/4 | M32-MC-MBS20- | 78.9 | 19.8 | 42.0 | 25.0 | 50 | 50 | 49.0 |
| 38 | 1 1/2 | M38-MC-MBS24- | 90.8 | 22.1 | 49.4 | 31.8 | 60 | 55 | 54.7 |

Штуцер с внешней резьбой

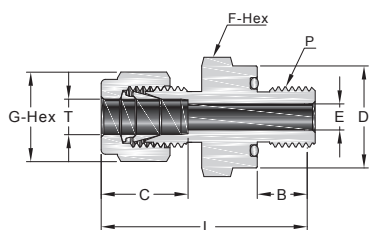

Дюймовая трубка

Прямая резьба SAE/MS с уплотнением

| Трубка, дюйм | P-SAE/MS Размер резьбы | Артикул для заказа | Размеры, мм | | | | | | | |
|--------------|------------------------------|-----------------------|-------------|------|------|------|------|------|------|--|
| | | | L | B | C | E | G | F | D | |
| 1/16 | 5/16-24 | F1-MC-STO5- | 26.7 | 8.6 | 8.6 | 1.3 | 7.9 | 14.3 | 14.0 | |
| 1/8 | 5/16-24 | F2-MC-STO5- | 32.8 | 8.6 | 12.7 | 2.3 | 11.1 | 14.3 | 14.0 | |
| 3/16 | 3/8-24 | F3-MC-STO6- | 34.3 | 9.7 | 13.7 | 3.0 | 12.7 | 15.9 | 15.7 | |
| 1/4 | 7/16-20 | F4-MC-STO7- | 38.4 | 10.4 | 15.2 | 4.8 | 14.3 | 19.1 | 18.8 | |
| 5/16 | 1/2-20 | F5-MC-STO8- | 40.6 | 11.2 | 16.3 | 6.4 | 15.9 | 22.2 | 21.8 | |
| 3/8 | 9/16-18 | F6-MC-STO9- | 42.4 | 11.9 | 16.8 | 7.1 | 17.5 | 23.8 | 23.6 | |
| 1/2 | 3/4-16 | F8-MC-STO12- | 46.0 | 11.9 | 22.9 | 10.4 | 22.2 | 28.6 | 28.4 | |
| 3/4 | 1 1/16-12 | F12-MC-STO17- | 52.3 | 14.2 | 24.4 | 15.7 | 28.6 | 38.1 | 37.8 | |
| 1 | 1 5/16-12 | F16-MC-STO21- | 58.2 | 14.2 | 31.2 | 22.4 | 38.1 | 44.5 | 44.2 | |

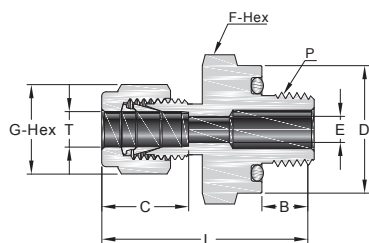

Дюймовая трубка

Резьба NPT с уплотнением

| Трубка, дюйм | P-NPT Резьба | Артикул для заказа | Размеры, мм | | | | | | | |
|--------------|-----------------|-----------------------|-------------|------|------|------|------|------|------|--|
| | | | L | B | C | E | G | F | D | |
| 1/8 | 1/8 | F2-MC-NPT02- | 32.8 | 7.1 | 8.6 | 2.3 | 11.1 | 19.1 | 18.8 | |
| 1/4 | 1/8 | F4-MC-NPT02- | 35.1 | 7.1 | 15.2 | 4.8 | 14.3 | 19.1 | 18.8 | |
| 1/4 | 1/4 | F4-MC-NPT04- | 38.4 | 9.7 | 15.2 | 4.8 | 14.3 | 23.8 | 23.6 | |
| 3/8 | 1/4 | F6-MC-NPT04- | 39.9 | 9.7 | 16.8 | 7.1 | 17.5 | 23.8 | 23.6 | |
| 3/8 | 3/8 | F6-MC-NPT06- | 41.4 | 10.4 | 16.8 | 7.1 | 17.5 | 28.6 | 28.4 | |
| 3/8 | 1/2 | F6-MC-NPT08- | 47.0 | 13.5 | 16.8 | 7.1 | 17.5 | 33.3 | 33.0 | |
| 1/2 | 1/2 | F8-MC-NPT08- | 49.8 | 13.5 | 22.9 | 10.4 | 22.2 | 33.3 | 33.0 | |

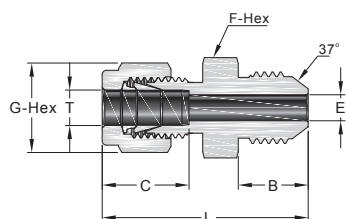

Дюймовая трубка

AN резьба 37°

| Трубка, дюйм | Размер резьбы AN | Артикул для заказа | Размеры, мм | | | | | |
|--------------|------------------------|-----------------------|-------------|------------|------------|------------|------------|------------|
| | | | L | B | C | E | G | F |
| 1/16 | 1/8 | F1-MC-AN2- | 1.07(27.2) | 0.45(11.4) | 0.34(8.6) | 0.05(1.3) | 0.31(7.9) | 0.44(11.1) |
| 1/8 | 1/8 | F2-MC-AN2- | 1.27(32.3) | 0.45(11.4) | 0.50(12.7) | 0.06(1.5) | 0.44(11.1) | 0.44(11.1) |
| 1/8 | 1/4 | F2-MC-AN4- | 1.38(35.1) | 0.55(14.0) | 0.50(12.7) | 0.09(2.3) | 0.44(11.1) | 0.50(12.7) |
| 3/16 | 3/16 | F3-MC-AN3- | 1.32(33.5) | 0.48(12.2) | 0.54(13.7) | 0.09(2.3) | 0.50(12.7) | 0.44(11.1) |
| 1/4 | 1/4 | F4-MC-AN4- | 1.48(37.6) | 0.55(14.0) | 0.60(15.2) | 0.17(4.3) | 0.56(14.3) | 0.50(12.7) |
| 5/16 | 5/16 | F5-MC-AN5- | 1.51(38.4) | 0.55(14.0) | 0.64(16.2) | 0.23(5.8) | 0.63(15.9) | 0.56(14.3) |
| 3/8 | 1/4 | F6-MC-AN4- | 1.56(39.6) | 0.55(14.0) | 0.66(16.8) | 0.17(4.3) | 0.69(17.5) | 0.63(15.9) |
| 3/8 | 3/8 | F6-MC-AN6- | 1.56(39.6) | 0.56(14.1) | 0.66(16.8) | 0.28(7.1) | 0.69(17.5) | 0.63(15.9) |
| 1/2 | 1/2 | F8-MC-AN8- | 1.81(46.0) | 0.66(16.7) | 0.90(22.8) | 0.39(9.9) | 0.87(22.2) | 0.81(20.6) |
| 5/8 | 5/8 | F10-MC-AN10- | 1.93(49.0) | 0.76(19.3) | 0.96(24.5) | 0.48(12.3) | 1.00(25.4) | 0.94(23.8) |
| 3/4 | 3/4 | F12-MC-AN12- | 2.10(53.3) | 0.86(21.9) | 0.96(24.4) | 0.61(15.5) | 1.13(28.6) | 1.13(28.6) |
| | 1 | F16-MC-AN16- | 2.42(61.5) | 0.91(23.1) | 1.23(31.2) | 0.84(21.3) | 1.50(38.1) | 1.37(34.9) |

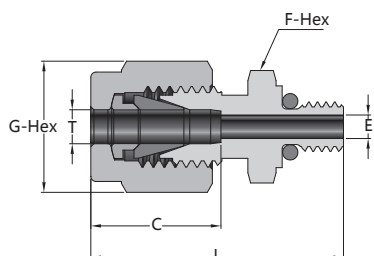

Дюймовая трубка

Резьба 10-32

| Трубка, дюйм | Артикул для заказа | Размеры, мм | | | | |
|--------------|-----------------------|-------------|------|-----|------|------|
| | | L | C | E | G | F |
| 1/8 | F2-MC-UNFD10 | 24.1 | 12.7 | 2.3 | 11.1 | 9.5 |
| 1/4 | F4-MC-UNFD10 | 27.4 | 15.2 | 2.3 | 14.3 | 12.7 |

Штуцер с внешней резьбой

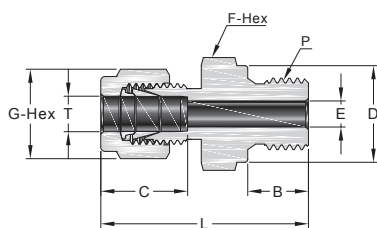

Дюймовая трубка

Метрическая резьба (BSMS)

| Трубка, дюйм | Р-размер метрической резьбы | Артикул для заказа | Размеры, мм | | | | | | |
|--------------|-----------------------------|--------------------|-------------|----|------|------|------|------|----|
| | | | L | B | C | E | G | F | D |
| 1/8 | M14x1.5 | F2-MC-BSMS14- | 36.7 | 12 | 12.7 | 2.3 | 11.1 | 19.1 | 19 |
| 1/8 | M16x1.5 | F2-MC-BSMS16- | 37.5 | 12 | 12.7 | 2.3 | 11.1 | 22.2 | 21 |
| 1/8 | M18x1.5 | F2-MC-BSMS18- | 38.5 | 12 | 12.7 | 2.3 | 11.1 | 23.8 | 23 |
| 1/8 | M20x1.5 | F2-MC-BSMS20- | 41.1 | 14 | 12.7 | 2.3 | 11.1 | 25.4 | 25 |
| 1/4 | M14x1.5 | F4-MC-BSMS14- | 38.0 | 12 | 15.2 | 4.8 | 14.3 | 19.1 | 19 |
| 1/4 | M16x1.5 | F4-MC-BSMS16- | 39.9 | 12 | 15.2 | 4.8 | 14.3 | 22.2 | 21 |
| 1/4 | M18x1.5 | F4-MC-BSMS18- | 40.8 | 12 | 15.2 | 4.8 | 14.3 | 23.8 | 23 |
| 1/4 | M20x1.5 | F4-MC-BSMS20- | 43.6 | 14 | 15.2 | 4.8 | 14.3 | 25.4 | 25 |
| 3/8 | M14x1.5 | F6-MC-BSMS14- | 41.3 | 12 | 16.8 | 7.1 | 17.5 | 19.1 | 19 |
| 3/8 | M16x1.5 | F6-MC-BSMS16- | 41.3 | 12 | 16.8 | 7.1 | 17.5 | 22.2 | 21 |
| 3/8 | M18x1.5 | F6-MC-BSMS18- | 41.8 | 12 | 16.8 | 7.1 | 17.5 | 23.8 | 23 |
| 3/8 | M20x1.5 | F6-MC-BSMS20- | 45.1 | 14 | 16.8 | 7.1 | 17.5 | 25.4 | 25 |
| 1/2 | M16x1.5 | F8-MC-BSMS16- | 44.0 | 12 | 22.9 | 9.0 | 22.2 | 22.2 | 21 |
| 1/2 | M18x1.5 | F8-MC-BSMS18- | 44.0 | 12 | 22.9 | 10.0 | 22.2 | 23.8 | 23 |
| 1/2 | M20x1.5 | F8-MC-BSMS20- | 47.9 | 14 | 22.9 | 10.4 | 22.2 | 25.4 | 25 |
| 1/2 | M22x1.5 | F8-MC-BSMS22- | 48.5 | 14 | 22.9 | 10.4 | 22.2 | 27.0 | 27 |

Метрическая трубка

Метрическая резьба (BSMS)

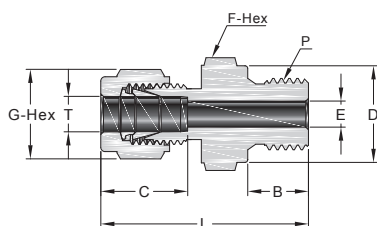

| Трубка, мм | Р-размер метрической резьбы | Артикул для заказа | Размеры, мм | | | | | | |
|------------|-----------------------------|--------------------|-------------|----|------|------|----|----|----|
| | | | L | B | C | E | G | F | D |
| 6 | M8 x 1 | M6-MC-BSMS8- | 33.3 | 8 | 15.3 | 3.0 | 14 | 14 | 12 |
| 6 | M10 x 1 | M6-MC-BSMS10- | 36.3 | 8 | 15.3 | 4.0 | 14 | 14 | 14 |
| 6 | M12 x 1.5 | M6-MC-BSMS12- | 38.2 | 12 | 15.3 | 4.8 | 14 | 18 | 17 |
| 6 | M14 x 1.5 | M6-MC-BSMS14- | 39.7 | 12 | 15.3 | 4.8 | 14 | 19 | 19 |
| 8 | M8 x 1 | M8-MC-BSMS8- | 34.1 | 8 | 16.2 | 3.0 | 16 | 14 | 12 |
| 8 | M10 x 1 | M8-MC-BSMS10- | 34.1 | 8 | 16.2 | 5.0 | 16 | 15 | 14 |
| 8 | M12 x 1.5 | M8-MC-BSMS12- | 40.4 | 12 | 16.2 | 6.0 | 16 | 18 | 17 |
| 8 | M14 x 1.5 | M8-MC-BSMS14- | 40.4 | 12 | 16.2 | 6.4 | 16 | 19 | 19 |
| 10 | M12 x 1.5 | M10-MC-BSMS12- | 40.7 | 12 | 17.2 | 6.0 | 19 | 18 | 17 |
| 10 | M14 x 1.5 | M10-MC-BSMS14- | 41.5 | 12 | 17.2 | 7.9 | 19 | 19 | 19 |
| 12 | M16 x 1.5 | M12-MC-BSMS16- | 45.5 | 12 | 22.8 | 9 | 22 | 22 | 21 |
| 12 | M20 x 1.5 | M12-MC-BSMS20- | 48.0 | 14 | 22.8 | 9.5 | 22 | 25 | 25 |
| 12 | M22 x 1.5 | M12-MC-BSMS22- | 49.5 | 14 | 22.8 | 9.5 | 22 | 27 | 27 |
| 14 | M14 x 1.5 | M14-MC-BSMS14- | 44.9 | 12 | 24.4 | 8 | 25 | 24 | 19 |
| 14 | M20 x 1.5 | M14-MC-BSMS20- | 48.0 | 14 | 24.4 | 11.1 | 25 | 25 | 25 |
| 16 | M20 x 1.5 | M16-MC-BSMS20- | 48.0 | 14 | 24.4 | 12 | 25 | 25 | 25 |
| 18 | M20 x 1.5 | M18-MC-BSMS20- | 48.5 | 14 | 24.4 | 12 | 30 | 27 | 25 |
| 20 | M20 x 1.5 | M20-MC-BSMS20- | 50.0 | 14 | 26.0 | 12 | 32 | 30 | 25 |
| 22 | M24 x 1.5 | M22-MC-BSMS24- | 50.5 | 14 | 26.0 | 15 | 32 | 30 | 29 |
| 25 | M27 x 2 | M25-MC-BSMS27- | 57.5 | 16 | 31.3 | 16.8 | 38 | 35 | 32 |

Штуцер с внешней резьбой

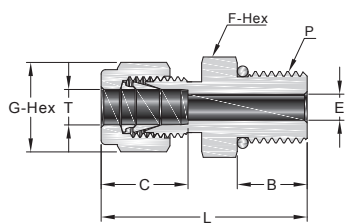

Adapt to straight thread boss of ISO 6149-1.

Дюймовая трубка

Метрическая резьба (OMS)

| Трубка, дюйм | Р-размер метрической резьбы | Артикул для заказа | Размеры, мм | | | | | |
|--------------|-----------------------------|--------------------|-------------|----|------|------|------|------|
| | | | L | B | C | E | G | F |
| 1/4 | M14X1.5 | F4-MC-OMS14- | 35.2 | 11 | 15.2 | 4.8 | 14.3 | 19.1 |
| 3/8 | M14X1.5 | F6-MC-OMS14- | 36.7 | 11 | 16.8 | 7.1 | 17.5 | 19.1 |
| 3/8 | M20X1.5 | F6-MC-OMS20- | 41.2 | 14 | 16.8 | 7.1 | 17.5 | 27.0 |
| 1/2 | M14X1.5 | F8-MC-OMS14- | 40.2 | 11 | 22.9 | 7.5 | 22.2 | 20.6 |
| 1/2 | M20X1.5 | F8-MC-OMS20- | 44.0 | 14 | 22.9 | 10.4 | 22.2 | 27.0 |

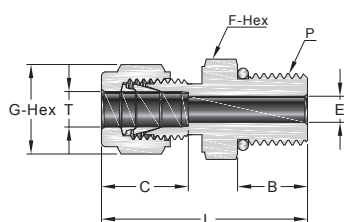

Адаптер по стандарту ISO 6149-1.

Метрическая трубка

Метрическая резьба (OMS)

| Трубка, мм | Р-размер метрической резьбы | Артикул для заказа | Размеры, мм | | | | | |
|------------|-----------------------------|--------------------|-------------|----|------|------|----|----|
| | | | L | B | C | E | G | F |
| 6 | M14 x 1.5 | M6-MC-OMS14- | 35.2 | 11 | 15.3 | 4.8 | 14 | 19 |
| 10 | M14 x 1.5 | M10-MC-OMS14- | 36.7 | 11 | 17.2 | 7.5 | 19 | 19 |
| 10 | M20 x 1.5 | M10-MC-OMS20- | 41.2 | 14 | 17.2 | 7.9 | 19 | 27 |
| 12 | M14 x 1.5 | M12-MC-OMS14- | 40.2 | 11 | 22.8 | 7.5 | 22 | 22 |
| 12 | M20 x 1.5 | M12-MC-OMS20- | 44.0 | 14 | 22.8 | 10.4 | 22 | 27 |

Дюймовая трубка

Метрическая резьба (MS)

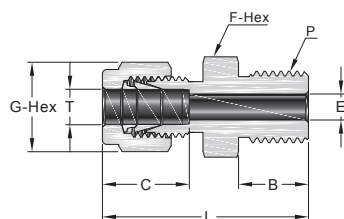

| Трубка, дюйм | Р-размер метрической резьбы | Артикул для заказа | Размеры, мм | | | | | |
|--------------|-----------------------------|--------------------|-------------|----|------|------|------|------|
| | | | L | B | C | E | G | F |
| 1/16 | M5x0.8 | F1-MC-MS5- | 21.8 | 8 | 8.6 | 1.3 | 7.9 | 7.9 |
| 1/8 | M14x1.5 | F2-MC-MS14- | 34.8 | 13 | 12.7 | 2.3 | 11.1 | 15.9 |
| 1/8 | M16x1.5 | F2-MC-MS16- | 35.8 | 14 | 12.7 | 2.3 | 11.1 | 17.5 |
| 1/8 | M18x1.5 | F2-MC-MS18- | 37.2 | 15 | 12.7 | 2.3 | 11.1 | 19.1 |
| 1/8 | M20x1.5 | F2-MC-MS20- | 38.2 | 16 | 12.7 | 2.3 | 11.1 | 22.2 |
| 1/4 | M14x1.5 | F4-MC-MS14- | 36.9 | 13 | 15.2 | 4.8 | 14.3 | 15.9 |
| 1/4 | M16x1.5 | F4-MC-MS16- | 38.1 | 14 | 15.2 | 4.8 | 14.3 | 17.5 |
| 1/4 | M18x1.5 | F4-MC-MS18- | 39.5 | 15 | 15.2 | 4.8 | 14.3 | 19.1 |
| 1/4 | M20x1.5 | F4-MC-MS20- | 40.7 | 16 | 15.2 | 4.8 | 14.3 | 22.2 |
| 3/8 | M10x1.0 | F4-MC-MS10- | 36.4 | 11 | 16.8 | 4.8 | 17.5 | 15.9 |
| 3/8 | M14x1.5 | F6-MC-MS14- | 39.3 | 13 | 16.8 | 7.1 | 17.5 | 15.9 |
| 3/8 | M16x1.5 | F6-MC-MS16- | 39.7 | 14 | 16.8 | 7.1 | 17.5 | 17.5 |
| 3/8 | M18x1.5 | F6-MC-MS18- | 41.5 | 15 | 16.8 | 7.1 | 17.5 | 19.1 |
| 3/8 | M20x1.5 | F6-MC-MS20- | 42.3 | 16 | 16.8 | 7.1 | 17.5 | 22.2 |
| 1/2 | M16x1.5 | F8-MC-MS16- | 43.2 | 14 | 22.9 | 8.4 | 22.2 | 20.6 |
| 1/2 | M18x1.5 | F8-MC-MS18- | 43.7 | 15 | 22.9 | 9.6 | 22.2 | 20.6 |
| 1/2 | M20x1.5 | F8-MC-MS20- | 44.9 | 16 | 22.9 | 10.4 | 22.2 | 22.2 |
| 1/2 | M22x1.5 | F8-MC-MS22- | 47.0 | 17 | 22.9 | 10.4 | 22.2 | 23.8 |

Штуцер с внешней резьбой

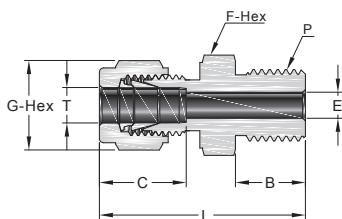

Метрическая трубка

Метрическая резьба (MS)

| Трубка, дюйм | Р-размер метрической резьбы | Артикул для заказа | Размеры, мм | | | | | |
|--------------|-----------------------------|--------------------|-------------|----|------|------|----|----|
| | | | L | B | C | E | G | F |
| 6 | M6 x 1 | M6-MC-MS6- | 32.4 | 8 | 15.3 | 2.0 | 14 | 14 |
| 6 | M8 x 1 | M6-MC-MS8- | 32.4 | 9 | 15.3 | 3.0 | 14 | 14 |
| 6 | M10 x 1 | M6-MC-MS10- | 35.2 | 11 | 15.3 | 4.7 | 14 | 14 |
| 6 | M12 x 1.5 | M6-MC-MS12- | 36.4 | 12 | 15.3 | 4.8 | 14 | 14 |
| 6 | M14 x 1.5 | M6-MC-MS14- | 37.4 | 13 | 15.3 | 4.8 | 14 | 16 |
| 6 | M16 x 1.5 | M6-MC-MS16- | 38.4 | 14 | 15.3 | 4.8 | 14 | 18 |
| 6 | M18 x 1.5 | M6-MC-MS18- | 40.0 | 15 | 15.3 | 4.8 | 14 | 19 |
| 6 | M20 x 1.5 | M6-MC-MS20- | 41.7 | 16 | 15.3 | 4.8 | 14 | 22 |
| 8 | M8 x 1 | M8-MC-MS8- | 34.5 | 9 | 16.2 | 3.0 | 16 | 14 |
| 8 | M10 x 1 | M8-MC-MS10- | 35.6 | 11 | 16.2 | 4.7 | 16 | 14 |
| 8 | M12 x 1.5 | M8-MC-MS12- | 36.6 | 12 | 16.2 | 6.0 | 16 | 14 |
| 8 | M14 x 1.5 | M8-MC-MS14- | 37.7 | 13 | 16.2 | 6.4 | 16 | 16 |
| 8 | M20 x 1.5 | M8-MC-MS20- | 42.5 | 16 | 16.2 | 6.4 | 16 | 22 |
| 10 | M12 x 1.5 | M10-MC-MS12- | 38.7 | 12 | 17.2 | 6.0 | 19 | 18 |
| 10 | M14 x 1.5 | M10-MC-MS14- | 39.7 | 13 | 17.2 | 7.2 | 19 | 18 |
| 10 | M20 x 1.5 | M10-MC-MS20- | 43.5 | 16 | 17.2 | 7.9 | 19 | 22 |
| 12 | M12 x 1.5 | M12-MC-MS12- | 41.2 | 12 | 22.8 | 6.0 | 22 | 22 |
| 12 | M16 x 1.5 | M12-MC-MS16- | 43.2 | 14 | 22.8 | 9.5 | 22 | 22 |
| 12 | M18 x 1.5 | M12-MC-MS18- | 44.2 | 15 | 22.8 | 9.5 | 22 | 22 |
| 12 | M20 x 1.5 | M12-MC-MS20- | 45.2 | 16 | 22.8 | 9.5 | 22 | 22 |
| 14 | M14 x 1.5 | M14-MC-MS14- | 42.5 | 13 | 24.4 | 7.2 | 25 | 24 |
| 14 | M16 x 1.5 | M14-MC-MS16- | 43.9 | 14 | 24.4 | 8.4 | 25 | 24 |
| 14 | M20 x 1.5 | M14-MC-MS20- | 45.1 | 16 | 24.4 | 10.8 | 25 | 24 |
| 16 | M20 x 1.5 | M16-MC-MS20- | 46.1 | 16 | 24.4 | 10.8 | 25 | 24 |
| 18 | M20 x 1.5 | M18-MC-MS20- | 47.5 | 16 | 24.4 | 10.8 | 30 | 27 |
| 18 | M22 x 1.5 | M18-MC-MS22- | 48.5 | 17 | 24.4 | 12 | 30 | 27 |
| 20 | M20 x 1.5 | M20-MC-MS20- | 49.5 | 16 | 26.0 | 10.8 | 32 | 30 |
| 22 | M24 x 1.5 | M22-MC-MS24- | 50.5 | 17 | 26.0 | 14.4 | 32 | 30 |
| 25 | M27 x 2 | M22-MC-MS27- | 57.0 | 18 | 31.3 | 16.1 | 38 | 35 |

Фитинги с внешней резьбой для термопар

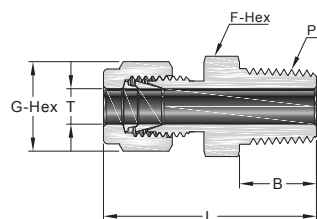

Дюймовая трубка

Резьба NPT

| Трубка, дюйм | P-NPT резьба | Артикул для заказа | Размеры, мм | | | |
|--------------|--------------|--------------------|-------------|------|------|------|
| | | | L | B | G | F |
| 1/16 | 1/16 | F1-TC-NPT1- | 23.9 | 9.7 | 7.9 | 7.9 |
| 1/16 | 1/8 | F1-TC-NPT2- | 26.2 | 9.7 | 7.9 | 11.1 |
| 1/16 | 1/4 | F1-TC-NPT4- | 31.0 | 14.2 | 7.9 | 14.3 |
| 1/8 | 1/16 | F2-TC-NPT1- | 29.7 | 9.7 | 11.1 | 11.1 |
| 1/8 | 1/8 | F2-TC-NPT2- | 30.5 | 9.7 | 11.1 | 11.1 |
| 1/8 | 1/4 | F2-TC-NPT4- | 35.6 | 14.2 | 11.1 | 14.3 |
| 3/16 | 1/8 | F3-TC-NPT2- | 31.2 | 9.7 | 12.7 | 11.1 |
| 3/16 | 1/4 | F3-TC-NPT4- | 36.3 | 14.2 | 12.7 | 14.3 |
| 1/4 | 1/8 | F4-TC-NPT2- | 32.8 | 9.7 | 14.3 | 12.7 |
| 1/4 | 1/4 | F4-TC-NPT4- | 37.8 | 14.2 | 14.3 | 14.3 |
| 1/4 | 3/8 | F4-TC-NPT6- | 38.4 | 14.2 | 14.3 | 17.5 |
| 1/4 | 1/2 | F4-TC-NPT8- | 44.7 | 19.1 | 14.3 | 22.2 |
| 5/16 | 1/4 | F5-TC-NPT4- | 38.6 | 14.2 | 15.9 | 14.3 |
| 3/8 | 1/4 | F6-TC-NPT4- | 39.9 | 14.2 | 17.5 | 15.9 |
| 3/8 | 3/8 | F6-TC-NPT6- | 39.9 | 14.2 | 17.5 | 17.5 |
| 3/8 | 1/2 | F6-TC-NPT8- | 46.2 | 19.1 | 17.5 | 22.2 |
| 3/8 | 3/4 | F6-TC-NPT12- | 47.8 | 19.1 | 17.5 | 27.0 |
| 1/2 | 1/2 | F8-TC-NPT8- | 49.0 | 19.1 | 22.2 | 22.2 |
| 1/2 | 3/4 | F8-TC-NPT12- | 50.5 | 19.1 | 22.2 | 27.0 |
| 5/8 | 3/4 | F10-TC-NPT12- | 50.5 | 19.1 | 25.4 | 27.0 |
| 3/4 | 3/4 | F12-TC-NPT12- | 50.5 | 19.1 | 28.6 | 27.0 |
| 1 | 1 | F16-TC-NPT16- | 62.2 | 23.9 | 38.1 | 34.9 |

Фитинги с внешней резьбой для терморпар

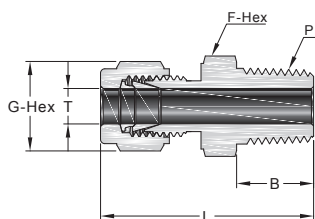

Метрическая трубка

Резьба NPT

| Трубка, мм | P-NPT резьба | Артикул для заказа | Размеры, мм | | | |
|---------------|-----------------|-----------------------|-------------|------|----|----|
| | | | L | B | G | F |
| 2 | 1/8 | M2-TC-NPT2- | 30.5 | 9.7 | 12 | 12 |
| 3 | 1/8 | M3-TC-NPT2- | 30.5 | 9.7 | 12 | 12 |
| 3 | 1/4 | M3-TC-NPT4- | 35.6 | 14.2 | 12 | 14 |
| 4 | 1/8 | M4-TC-NPT2- | 31.2 | 9.7 | 12 | 12 |
| 4 | 1/4 | M4-TC-NPT4- | 36.3 | 14.2 | 12 | 14 |
| 6 | 1/8 | M6-TC-NPT2- | 32.8 | 9.7 | 14 | 14 |
| 6 | 1/4 | M6-TC-NPT4- | 37.9 | 14.2 | 14 | 14 |
| 6 | 3/8 | M6-TC-NPT6- | 38.4 | 14.2 | 14 | 18 |
| 6 | 1/2 | M6-TC-NPT8- | 44.7 | 19.1 | 14 | 22 |
| 8 | 1/4 | M8-TC-NPT4- | 38.7 | 14.2 | 16 | 15 |
| 8 | 3/8 | M8-TC-NPT6- | 39.3 | 14.2 | 16 | 18 |
| 8 | 1/2 | M8-TC-NPT8- | 45.6 | 19.1 | 16 | 22 |
| 10 | 3/8 | M10-TC-NPT6- | 40.9 | 14.2 | 19 | 18 |
| 10 | 1/2 | M10-TC-NPT8- | 46.5 | 19.1 | 19 | 22 |
| 10 | 3/4 | M10-TC-NPT12- | 48.0 | 19.1 | 19 | 27 |
| 10 | 1 | M10-TC-NPT16- | 54.6 | 23.9 | 19 | 35 |
| 12 | 3/8 | M12-TC-NPT6- | 43.4 | 14.2 | 22 | 22 |
| 12 | 1/2 | M12-TC-NPT8- | 49.0 | 19.1 | 22 | 22 |
| 12 | 3/4 | M12-TC-NPT12- | 50.5 | 19.1 | 22 | 27 |
| 14 | 1/2 | M14-TC-NPT8- | 49.0 | 19.1 | 25 | 24 |
| 14 | 3/4 | M14-TC-NPT12- | 50.5 | 19.1 | 25 | 27 |
| 15 | 1/2 | M15-TC-NPT8- | 49.0 | 19.1 | 25 | 24 |
| 15 | 3/4 | M15-TC-NPT12- | 50.5 | 19.1 | 25 | 27 |
| 15 | 1 | M15-TC-NPT16- | 57.1 | 23.9 | 25 | 35 |
| 16 | 3/4 | M16-TC-NPT12- | 50.5 | 19.1 | 25 | 27 |
| 18 | 3/4 | M18-TC-NPT12- | 50.5 | 19.1 | 30 | 27 |
| 20 | 1 | M20-TC-NPT16- | 57.1 | 23.9 | 32 | 35 |
| 22 | 1 | M22-TC-NPT16- | 57.1 | 23.9 | 32 | 35 |
| 25 | 1 | M25-TC-NPT16- | 62.3 | 23.9 | 38 | 35 |

Штуцер с внешней резьбой и монтажом на панель

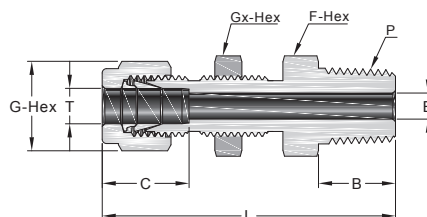

Дюймовая трубка

Резьба NPT

| Трубка, дюйм | P-NPT резьба | Артикул для заказа | Размеры, мм | | | | | | | Диаметр отверстия в панели, мм | Макс. толщина панели, мм |
|-----------------|-----------------|-----------------------|-------------|------|------|------|------|------|------|--------------------------------------|--------------------------------|
| | | | L | B | C | E | G | F | Gx | | |
| 1/16 | 1/16 | F1-BMC-NPT1- | 30.2 | 9.7 | 8.6 | 1.3 | 7.9 | 7.9 | 7.9 | 5.2 | 6.4 |
| 1/16 | 1/8 | F1-BMC-NPT2- | 32.3 | 9.7 | 8.6 | 1.3 | 7.9 | 11.1 | 7.9 | 5.2 | 6.4 |
| 1/8 | 1/8 | F2-BMC-NPT2- | 46.5 | 9.7 | 12.7 | 2.3 | 11.1 | 12.7 | 12.7 | 8.3 | 12.7 |
| 3/16 | 1/8 | F3-BMC-NPT2- | 48.0 | 9.7 | 13.7 | 3.0 | 12.7 | 14.3 | 14.3 | 9.9 | 12.7 |
| 1/4 | 1/8 | F4-BMC-NPT2- | 49.5 | 9.7 | 15.2 | 4.8 | 14.3 | 15.9 | 15.9 | 11.5 | 10.2 |
| 1/4 | 1/4 | F4-BMC-NPT4- | 54.1 | 14.2 | 15.2 | 4.8 | 14.3 | 15.9 | 15.9 | 11.5 | 10.2 |
| 1/4 | 3/8 | F4-BMC-NPT6- | 54.9 | 14.2 | 15.2 | 4.8 | 14.3 | 17.5 | 15.9 | 11.5 | 10.2 |
| 1/4 | 1/2 | F4-BMC-NPT8- | 60.3 | 19.1 | 15.2 | 4.8 | 14.3 | 22.2 | 15.9 | 11.5 | 10.2 |
| 5/16 | 1/8 | F5-BMC-NPT2- | 52.8 | 9.7 | 16.3 | 4.8 | 15.9 | 17.5 | 17.5 | 13.1 | 11.2 |
| 5/16 | 1/4 | F5-BMC-NPT4- | 57.7 | 14.2 | 16.3 | 6.4 | 15.9 | 17.5 | 17.5 | 13.1 | 11.2 |
| 3/8 | 1/8 | F6-BMC-NPT2- | 52.9 | 9.7 | 16.8 | 4.8 | 17.5 | 19.1 | 19.1 | 14.7 | 11.2 |
| 3/8 | 1/4 | F6-BMC-NPT4- | 57.4 | 14.2 | 16.8 | 7.1 | 17.5 | 19.1 | 19.1 | 14.7 | 11.2 |
| 3/8 | 3/8 | F6-BMC-NPT6- | 57.4 | 14.2 | 16.8 | 7.1 | 17.5 | 19.1 | 19.1 | 14.7 | 11.2 |
| 3/8 | 1/2 | F6-BMC-NPT8- | 63.8 | 19.1 | 16.8 | 7.1 | 17.5 | 22.2 | 19.1 | 14.7 | 11.2 |
| 1/2 | 1/8 | F8-BMC-NPT2- | 58.7 | 9.7 | 22.9 | 4.8 | 22.2 | 23.8 | 23.8 | 19.4 | 12.7 |
| 1/2 | 1/4 | F8-BMC-NPT4- | 63.2 | 14.2 | 22.9 | 7.1 | 22.2 | 23.8 | 23.8 | 19.4 | 12.7 |
| 1/2 | 3/8 | F8-BMC-NPT6- | 63.2 | 14.2 | 22.9 | 9.7 | 22.2 | 23.8 | 23.8 | 19.4 | 12.7 |
| 1/2 | 1/2 | F8-BMC-NPT8- | 68.8 | 19.1 | 22.9 | 10.4 | 22.2 | 23.8 | 23.8 | 19.4 | 12.7 |
| 5/8 | 3/8 | F10-BMC-NPT6- | 66.7 | 14.2 | 24.4 | 9.7 | 25.4 | 27.0 | 27.0 | 22.6 | 15.1 |
| 5/8 | 1/2 | F10-BMC-NPT8- | 71.5 | 19.1 | 24.4 | 11.9 | 25.4 | 27.0 | 27.0 | 22.6 | 15.1 |
| 3/4 | 1/2 | F12-BMC-NPT8- | 76.2 | 19.1 | 24.4 | 11.9 | 28.6 | 30.2 | 30.2 | 25.8 | 16.8 |
| 3/4 | 3/4 | F12-BMC-NPT12- | 76.2 | 19.1 | 24.4 | 15.7 | 28.6 | 30.2 | 30.2 | 25.8 | 16.8 |
| 7/8 | 3/4 | F14-BMC-NPT12- | 84.1 | 19.1 | 25.9 | 15.7 | 31.8 | 33.3 | 33.3 | 29.0 | 19.1 |
| 1 | 3/4 | F16-BMC-NPT12- | 88.4 | 19.1 | 31.2 | 15.7 | 38.1 | 41.3 | 41.3 | 33.7 | 19.1 |
| 1 | 1 | F16-BMC-NPT16- | 93.2 | 23.9 | 31.2 | 22.4 | 38.1 | 41.3 | 41.3 | 33.7 | 19.1 |

Метрическая трубка

Резьба NPT

| Трубка, мм | P-NPT резьба | Артикул для заказа | Размеры, мм | | | | | | | Диаметр отверстия в панели, мм | Макс. толщина панели, мм |
|---------------|-----------------|-----------------------|-------------|------|------|-----|----|----|----|--------------------------------------|--------------------------------|
| | | | L | B | C | E | G | F | Gx | | |
| 6 | 1/8 | M6-BMC-NPT2- | 49.6 | 9.7 | 15.3 | 4.8 | 14 | 16 | 16 | 11.5 | 10.2 |
| 6 | 1/4 | M6-BMC-NPT4- | 53.6 | 14.2 | 15.3 | 4.8 | 14 | 16 | 16 | 11.5 | 10.2 |
| 8 | 1/8 | M8-BMC-NPT2- | 52.3 | 9.7 | 16.2 | 4.8 | 16 | 18 | 18 | 13.1 | 11.2 |
| 8 | 1/4 | M8-BMC-NPT4- | 57.5 | 14.2 | 16.2 | 6.4 | 16 | 18 | 18 | 13.1 | 11.2 |
| 10 | 1/4 | M10-BMC-NPT4- | 58.4 | 14.2 | 17.2 | 7.9 | 19 | 22 | 22 | 16.3 | 11.2 |
| 10 | 3/8 | M10-BMC-NPT6- | 58.4 | 14.2 | 17.2 | 7.9 | 19 | 22 | 22 | 16.3 | 11.2 |
| 10 | 1/2 | M10-BMC-NPT8- | 63.1 | 19.1 | 17.2 | 7.9 | 19 | 22 | 22 | 16.3 | 11.2 |
| 12 | 1/4 | M12-BMC-NPT4- | 63.9 | 14.2 | 22.8 | 7.9 | 22 | 24 | 24 | 19.5 | 12.7 |
| 12 | 3/8 | M12-BMC-NPT6- | 63.9 | 14.2 | 22.8 | 9.5 | 22 | 24 | 24 | 19.5 | 12.7 |
| 12 | 1/2 | M12-BMC-NPT8- | 68.8 | 19.1 | 22.8 | 9.5 | 22 | 24 | 24 | 19.5 | 12.7 |

Штуцер с внешней резьбой и монтажом на панель

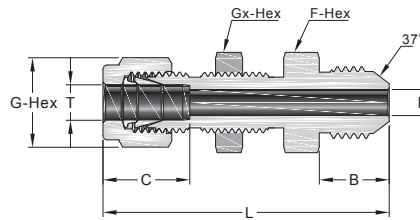

Дюймовая трубка

АН резьба 37°

| Трубка, дюйм | Размер резьбы АН | Артикул для заказа | Размеры, дюйм (мм) | | | | | | | Диаметр отверстия в панели, мм | Макс. толщина панели, мм |
|--------------|------------------|--------------------|--------------------|-------------|-------------|-------------|-------------|-------------|-------------|--------------------------------|--------------------------|
| | | | L | B | C | E | G | F | Gx | | |
| 1/8 | 1/8 | F2-BMC-AN2- | 1.91 (48.5) | 0.45 (11.4) | 0.50 (12.7) | 0.06 (1.5) | 0.44 (11.1) | 0.50 (12.7) | 0.50 (12.7) | 0.33 (8.3) | 0.50 (12.7) |
| 1/8 | 1/4 | F2-BMC-AN4- | 2.04 (51.8) | 0.55 (14.0) | 0.50 (12.7) | 0.09 (2.3) | 0.44 (11.1) | 0.63 (15.9) | 0.50 (12.7) | 0.33 (8.3) | 0.51 (12.7) |
| 3/16 | 3/16 | F3-BMC-AN3- | 1.98 (50.3) | 0.48 (12.2) | 0.54 (13.7) | 0.09 (2.3) | 0.50 (12.7) | 0.56 (14.3) | 0.56 (14.3) | 0.39 (9.9) | 0.50 (12.7) |
| 1/4 | 1/4 | F4-BMC-AN4- | 2.12 (53.8) | 0.55 (14.0) | 0.60 (15.2) | 0.17 (4.3) | 0.56 (14.3) | 0.63 (15.9) | 0.63 (15.9) | 0.45 (11.5) | 0.40 (10.2) |
| 5/16 | 5/16 | F5-BMC-AN5- | 2.21 (56.1) | 0.55 (14.0) | 0.64 (16.2) | 0.23 (5.8) | 0.63 (15.9) | 0.69 (17.5) | 0.69 (17.5) | 0.52 (13.1) | 0.56 (14.3) |
| 3/8 | 1/4 | F6-BMC-AN4- | 2.25 (57.2) | 0.55 (14.0) | 0.66 (16.8) | 0.17 (4.3) | 0.69 (17.5) | 0.75 (19.1) | 0.75 (19.1) | 0.58 (14.7) | 0.44 (11.2) |
| 3/8 | 3/8 | F6-BMC-AN6- | 2.25 (57.2) | 0.56 (14.2) | 0.66 (16.8) | 0.28 (7.1) | 0.69 (17.5) | 0.75 (19.1) | 0.75 (19.1) | 0.58 (14.7) | 0.44 (11.2) |
| 1/2 | 1/2 | F8-BMC-AN8- | 2.59 (65.8) | 0.66 (16.8) | 0.90 (22.8) | 0.39 (9.9) | 0.87 (22.2) | 0.94 (23.8) | 0.94 (23.8) | 0.76 (19.4) | 0.50 (12.7) |
| 5/8 | 5/8 | F10-BMC-AN10- | 2.74 (69.6) | 0.76 (19.3) | 0.96 (24.4) | 0.48 (12.3) | 1.00 (25.4) | 1.06 (27.0) | 1.06 (27.0) | 0.89 (22.6) | 0.59 (15.1) |
| 3/4 | 3/4 | F12-BMC-AN12- | 3.11 (79.0) | 0.86 (21.8) | 0.96 (24.4) | 0.61 (15.5) | 1.13 (28.6) | 1.19 (30.2) | 1.19 (30.2) | 1.02 (25.8) | 0.66 (16.8) |
| 1 | 1 | F16-BMC-AN16- | 3.64 (92.5) | 0.91 (23.1) | 1.23 (31.2) | 0.84 (21.3) | 1.50 (38.1) | 1.63 (41.3) | 1.63 (41.3) | 1.33 (33.7) | 0.75 (19.1) |

Фитинг с внутренней резьбой

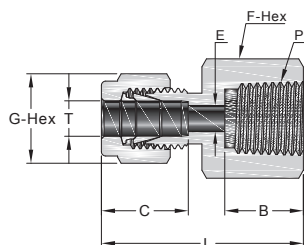

Дюймовая трубка

Резьба NPT

| Трубка, дюйм | P-NPT резьба | Артикул для заказа | Размеры, мм | | | | | |
|--------------|--------------|--------------------|-------------|------|------|------|------|------|
| | | | L | B | C | E | G | F |
| 1/16 | 1/16 | F1-FC-FNPT1- | 23.6 | 9.9 | 8.6 | 1.3 | 7.9 | 11.1 |
| 1/16 | 1/8 | F1-FC-FNPT2- | 24.4 | 10.4 | 8.6 | 1.3 | 7.9 | 14.3 |
| 1/8 | 1/8 | F2-FC-FNPT2- | 28.7 | 10.4 | 12.7 | 2.3 | 11.1 | 14.3 |
| 1/8 | 1/4 | F2-FC-FNPT4- | 33.5 | 15.0 | 12.7 | 2.3 | 11.1 | 19.1 |
| 3/16 | 1/8 | F3-FC-FNPT2- | 29.7 | 10.4 | 13.7 | 3.0 | 12.7 | 14.3 |
| 1/4 | 1/8 | F4-FC-FNPT2- | 31.2 | 10.4 | 15.2 | 4.8 | 14.3 | 14.3 |
| 1/4 | 1/4 | F4-FC-FNPT4- | 35.8 | 15.0 | 15.2 | 4.8 | 14.3 | 19.1 |
| 1/4 | 3/8 | F4-FC-FNPT6- | 37.6 | 15.0 | 15.2 | 4.8 | 14.3 | 22.2 |
| 1/4 | 1/2 | F4-FC-FNPT8- | 42.4 | 19.8 | 15.2 | 4.8 | 14.3 | 27.0 |
| 5/16 | 1/8 | F5-FC-FNPT2- | 32.0 | 10.4 | 16.3 | 6.4 | 15.9 | 14.3 |
| 5/16 | 1/4 | F5-FC-FNPT4- | 36.8 | 15.0 | 16.3 | 6.4 | 15.9 | 19.1 |
| 3/8 | 1/8 | F6-FC-FNPT2- | 32.8 | 10.4 | 16.8 | 7.1 | 17.5 | 15.9 |
| 3/8 | 1/4 | F6-FC-FNPT4- | 37.6 | 15.0 | 16.8 | 7.1 | 17.5 | 19.1 |
| 3/8 | 3/8 | F6-FC-FNPT6- | 39.1 | 15.0 | 16.8 | 7.1 | 17.5 | 22.2 |
| 3/8 | 1/2 | F6-FC-FNPT8- | 43.9 | 19.8 | 16.8 | 7.1 | 17.5 | 27.0 |
| 3/8 | 3/4 | F6-FC-FNPT12- | 47.8 | 20.6 | 16.8 | 7.1 | 17.5 | 33.3 |
| 1/2 | 1/4 | F8-FC-FNPT4- | 40.4 | 15.0 | 22.9 | 10.4 | 22.2 | 20.6 |
| 1/2 | 3/8 | F8-FC-FNPT6- | 41.9 | 15.0 | 22.9 | 10.4 | 22.2 | 22.2 |
| 1/2 | 1/2 | F8-FC-FNPT8- | 46.7 | 19.8 | 22.9 | 10.4 | 22.2 | 27.0 |
| 1/2 | 3/4 | F8-FC-FNPT12- | 48.3 | 20.6 | 22.9 | 10.4 | 22.2 | 33.3 |
| 5/8 | 3/8 | F10-FC-FNPT6- | 41.9 | 15.0 | 24.4 | 12.7 | 25.4 | 23.8 |
| 5/8 | 1/2 | F10-FC-FNPT8- | 46.7 | 19.8 | 24.4 | 12.7 | 25.4 | 27.0 |
| 3/4 | 1/2 | F12-FC-FNPT8- | 46.7 | 19.8 | 24.4 | 15.7 | 28.6 | 27.0 |
| 3/4 | 3/4 | F12-FC-FNPT12- | 48.3 | 20.6 | 24.4 | 15.7 | 28.6 | 33.3 |
| 7/8 | 3/4 | F14-FC-FNPT12- | 49.8 | 20.6 | 25.9 | 18.3 | 31.8 | 33.3 |
| 1 | 3/4 | F16-FC-FNPT12- | 53.3 | 20.6 | 31.2 | 22.4 | 38.1 | 34.9 |
| 1 | 1 | F16-FC-FNPT16- | 62.2 | 25.4 | 31.2 | 22.4 | 38.1 | 41.3 |
| 1 1/4 | 1 1/4 | F20-FC-FNPT20- | 74.7 | 25.4 | 41.1 | 27.7 | 47.6 | 54.0 |
| 1 1/2 | 1 1/2 | F24-FC-FNPT24- | 83.3 | 27.7 | 50.0 | 36.3 | 57.2 | 60.3 |

Фитинг с внутренней резьбой

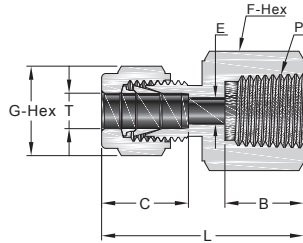

Метрическая трубка

Резьба NPT

| Трубка, мм | P-NPT резьба | Артикул для заказа | Размеры, мм | | | | | |
|------------|--------------|--------------------|-------------|------|------|------|----|----|
| | | | L | B | C | E | G | F |
| 3 | 1/8 | M3-FC-FNPT2- | 28.7 | 10.4 | 12.9 | 2.4 | 12 | 14 |
| 3 | 1/4 | M3-FC-FNPT4- | 33.5 | 15.0 | 12.9 | 2.4 | 12 | 19 |
| 4 | 1/8 | M4-FC-FNPT2- | 29.7 | 10.4 | 13.7 | 2.4 | 12 | 14 |
| 6 | 1/8 | M6-FC-FNPT2- | 31.3 | 10.4 | 15.3 | 4.8 | 14 | 14 |
| 6 | 1/4 | M6-FC-FNPT4- | 35.8 | 15.0 | 15.3 | 4.8 | 14 | 19 |
| 6 | 3/8 | M6-FC-FNPT6- | 37.7 | 15.0 | 15.3 | 4.8 | 14 | 22 |
| 6 | 1/2 | M6-FC-FNPT8- | 42.5 | 19.8 | 15.3 | 4.8 | 14 | 27 |
| 8 | 1/8 | M8-FC-FNPT2- | 32.1 | 10.4 | 16.2 | 6.4 | 16 | 15 |
| 8 | 1/4 | M8-FC-FNPT4- | 37.0 | 15.0 | 16.2 | 6.4 | 16 | 19 |
| 8 | 3/8 | M8-FC-FNPT6- | 38.5 | 15.0 | 16.2 | 6.4 | 16 | 22 |
| 8 | 1/2 | M8-FC-FNPT8- | 43.3 | 19.8 | 16.2 | 6.4 | 16 | 27 |
| 10 | 1/8 | M10-FC-FNPT2- | 33.0 | 10.4 | 17.2 | 6.4 | 19 | 18 |
| 10 | 1/4 | M10-FC-FNPT4- | 37.8 | 15.0 | 17.2 | 7.9 | 19 | 19 |
| 10 | 3/8 | M10-FC-FNPT6- | 39.4 | 15.0 | 17.2 | 7.9 | 19 | 22 |
| 10 | 1/2 | M10-FC-FNPT8- | 44.2 | 19.8 | 17.2 | 7.9 | 19 | 27 |
| 12 | 1/4 | M12-FC-FNPT4- | 40.3 | 15.0 | 22.8 | 7.9 | 22 | 22 |
| 12 | 3/8 | M12-FC-FNPT6- | 41.9 | 15.0 | 22.8 | 9.5 | 22 | 22 |
| 12 | 1/2 | M12-FC-FNPT8- | 46.7 | 19.8 | 22.8 | 9.5 | 22 | 27 |
| 12 | 3/4 | M12-FC-FNPT12- | 49.7 | 20.6 | 22.8 | 9.5 | 22 | 35 |
| 14 | 3/4 | M14-FC-FNPT12- | 49.7 | 20.6 | 24.4 | 11.1 | 25 | 35 |
| 15 | 1/2 | M15-FC-FNPT8- | 46.7 | 19.8 | 24.4 | 11.9 | 25 | 27 |
| 16 | 3/8 | M16-FC-FNPT6- | 41.9 | 15.0 | 24.4 | 9.5 | 25 | 27 |
| 16 | 1/2 | M16-FC-FNPT8- | 46.9 | 19.8 | 24.4 | 11.9 | 25 | 27 |
| 20 | 1/2 | M20-FC-FNPT8- | 47.9 | 19.8 | 26.0 | 11.9 | 32 | 30 |
| 20 | 3/4 | M20-FC-FNPT12- | 49.7 | 20.6 | 26.0 | 15.9 | 32 | 35 |
| 22 | 3/4 | M22-FC-FNPT12- | 49.7 | 20.6 | 26.0 | 15.9 | 32 | 35 |
| 22 | 1 | M22-FC-FNPT16- | 57.9 | 25.4 | 26.0 | 18.3 | 32 | 41 |
| 25 | 3/4 | M25-FC-FNPT12- | 53.4 | 20.6 | 31.3 | 15.9 | 38 | 35 |
| 25 | 1 | M25-FC-FNPT16- | 62.3 | 25.4 | 31.3 | 21.8 | 38 | 41 |

Фитинг с внутренней резьбой

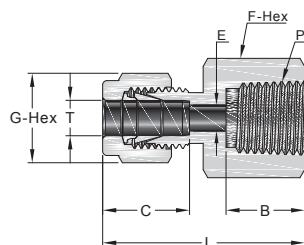

Дюймовая трубка

Коническая резьба ISO (BSPT)

| Трубка, дюйм | P-BSPT Резьба | Артикул для заказа | Размеры, мм | | | | | |
|--------------|---------------|--------------------|-------------|------|------|------|------|------|
| | | | L | B | C | E | G | F |
| 1/4 | 1/8 | F4-FC-FBT2- | 31.2 | 10.4 | 15.2 | 4.8 | 14.3 | 14.3 |
| 1/4 | 1/4 | F4-FC-FBT4- | 35.8 | 15.0 | 15.2 | 4.8 | 14.3 | 19.1 |
| 1/4 | 3/8 | F4-FC-FBT6- | 37.6 | 15.0 | 15.2 | 4.8 | 14.3 | 22.2 |
| 1/4 | 1/2 | F4-FC-FBT8- | 42.4 | 19.8 | 15.2 | 4.8 | 14.3 | 27.0 |
| 3/8 | 1/4 | F6-FC-FBT4- | 37.6 | 15.0 | 16.8 | 7.1 | 17.5 | 19.1 |
| 3/8 | 3/8 | F6-FC-FBT6- | 39.1 | 15.0 | 16.8 | 7.1 | 17.5 | 22.2 |
| 3/8 | 1/2 | F6-FC-FBT8- | 43.9 | 19.8 | 16.8 | 7.1 | 17.5 | 27.0 |
| 1/2 | 1/4 | F8-FC-FBT4- | 40.4 | 15.0 | 22.9 | 10.4 | 22.2 | 20.6 |
| 1/2 | 3/8 | F8-FC-FBT6- | 41.9 | 15.0 | 22.9 | 10.4 | 22.2 | 22.2 |
| 1/2 | 1/2 | F8-FC-FBT8- | 46.7 | 19.8 | 22.9 | 10.4 | 22.2 | 27.0 |

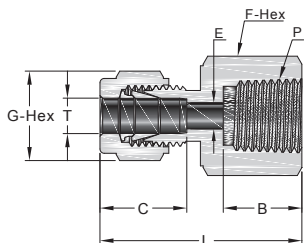

Метрическая трубка

Коническая резьба ISO (BSPT)

| Трубка, мм | P-BSPT Резьба | Артикул для заказа | Размеры, мм | | | | | |
|------------|---------------|--------------------|-------------|------|------|------|----|----|
| | | | L | B | C | E | G | F |
| 3 | 1/8 | M3-FC-FBT2- | 28.7 | 10.4 | 12.9 | 2.4 | 12 | 14 |
| 6 | 1/8 | M6-FC-FBT2- | 31.3 | 10.4 | 15.3 | 4.8 | 14 | 14 |
| 6 | 1/4 | M6-FC-FBT4- | 35.8 | 15.0 | 15.3 | 4.8 | 14 | 19 |
| 6 | 3/8 | M6-FC-FBT6- | 36.9 | 15.0 | 15.3 | 4.8 | 14 | 22 |
| 6 | 1/2 | M6-FC-FBT8- | 42.5 | 19.8 | 15.3 | 4.8 | 14 | 27 |
| 8 | 1/8 | M8-FC-FBT2- | 32.1 | 10.4 | 16.2 | 6.4 | 16 | 15 |
| 8 | 1/4 | M8-FC-FBT4- | 37.0 | 15.0 | 16.2 | 6.4 | 16 | 19 |
| 8 | 3/8 | M8-FC-FBT6- | 38.5 | 15.0 | 16.2 | 6.4 | 16 | 22 |
| 8 | 1/2 | M8-FC-FBT8- | 43.3 | 19.8 | 16.2 | 6.4 | 16 | 27 |
| 10 | 1/8 | M10-FC-FBT2- | 33.0 | 10.4 | 17.2 | 7.9 | 19 | 18 |
| 10 | 1/4 | M10-FC-FBT4- | 37.8 | 15.0 | 17.2 | 7.9 | 19 | 19 |
| 10 | 3/8 | M10-FC-FBT6- | 39.4 | 15.0 | 17.2 | 7.9 | 19 | 22 |
| 10 | 1/2 | M10-FC-FBT8- | 44.2 | 19.8 | 17.2 | 7.9 | 19 | 27 |
| 12 | 1/8 | M12-FC-FBT2- | 35.5 | 10.4 | 22.8 | 8.3 | 22 | 22 |
| 12 | 1/4 | M12-FC-FBT4- | 40.3 | 15.0 | 22.8 | 9.5 | 22 | 22 |
| 12 | 3/8 | M12-FC-FBT6- | 41.9 | 15.0 | 22.8 | 9.5 | 22 | 22 |
| 12 | 1/2 | M12-FC-FBT8- | 46.7 | 19.8 | 22.8 | 9.5 | 22 | 27 |
| 12 | 3/4 | M12-FC-FBT12- | 49.0 | 20.6 | 22.8 | 9.5 | 22 | 35 |
| 15 | 1/2 | M15-FC-FBT8- | 46.7 | 19.8 | 24.4 | 11.9 | 25 | 27 |
| 16 | 1/2 | M16-FC-FBT8- | 48.4 | 19.8 | 24.4 | 11.9 | 25 | 27 |
| 16 | 3/4 | M16-FC-FBT12- | 49.7 | 20.6 | 24.4 | 12.7 | 25 | 35 |
| 20 | 1/2 | M20-FC-FBT8- | 47.9 | 19.8 | 26.0 | 11.9 | 32 | 30 |
| 20 | 3/4 | M20-FC-FBT12- | 49.7 | 20.6 | 26.0 | 15.9 | 32 | 35 |
| 22 | 3/4 | M22-FC-FBT12- | 49.7 | 20.6 | 26.0 | 15.9 | 32 | 35 |
| 22 | 1 | M22-FC-FBT16- | 57.9 | 25.4 | 26.0 | 18.3 | 32 | 41 |
| 25 | 3/4 | M25-FC-FBT12- | 53.4 | 20.6 | 31.3 | 15.9 | 38 | 35 |
| 25 | 1 | M25-FC-FBT16- | 62.3 | 25.4 | 31.3 | 21.8 | 38 | 41 |

Фитинг с внутренней резьбой

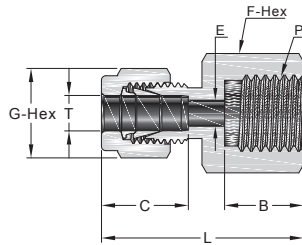

Дюймовая трубка

Цилиндрическая резьба ISO (BG)

| Трубка, дюйм | P-BG Резьба | Артикул для заказа | Размеры, мм | | | | | |
|--------------|-------------|--------------------|-------------|------|------|-----|------|------|
| | | | L | B | C | E | G | F |
| 1/8 | 1/4 | F2-FC-FBP4- | 35.3 | 12.9 | 12.7 | 2.3 | 11.1 | 19.1 |
| 1/8 | 3/8 | F2-FC-FBP6- | 38.7 | 14.2 | 12.7 | 2.3 | 11.1 | 23.8 |
| 1/4 | 1/4 | F4-FC-FBP4- | 37.6 | 12.9 | 15.2 | 4.8 | 14.3 | 19.1 |
| 1/4 | 3/8 | F4-FC-FBP6- | 37.6 | 14.2 | 15.2 | 4.8 | 14.3 | 23.8 |
| 1/4 | 1/2 | F4-FC-FBP8- | 43.4 | 18.8 | 15.2 | 4.8 | 14.3 | 27.0 |
| 5/16 | 1/4 | F5-FC-FBP4- | 38.4 | 12.9 | 16.3 | 5.6 | 15.9 | 19.1 |
| 5/16 | 3/8 | F5-FC-FBP6- | 39.2 | 14.2 | 16.3 | 6.4 | 15.9 | 23.8 |
| 5/16 | 1/2 | F5-FC-FBP8- | 40.9 | 18.8 | 16.3 | 7.1 | 15.9 | 27.0 |
| 3/8 | 1/4 | F6-FC-FBP4- | 39.1 | 12.9 | 16.8 | 5.6 | 17.5 | 19.1 |
| 3/8 | 3/8 | F6-FC-FBP6- | 38.6 | 14.2 | 16.8 | 6.4 | 17.5 | 23.8 |
| 3/8 | 1/2 | F6-FC-FBP8- | 41.9 | 18.8 | 16.8 | 7.1 | 17.5 | 27.0 |
| 1/2 | 1/4 | F8-FC-FBP4- | 41.9 | 12.9 | 22.9 | 5.6 | 22.2 | 22.2 |
| 1/2 | 3/8 | F8-FC-FBP6- | 44.5 | 14.2 | 22.9 | 6.4 | 22.2 | 23.8 |
| 1/2 | 1/2 | F8-FC-FBP8- | 48.3 | 18.8 | 22.9 | 7.1 | 22.2 | 27.0 |

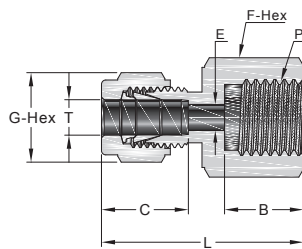

Метрическая трубка

Цилиндрическая резьба ISO (BG)

| Трубка, мм | P-BG Резьба | Артикул для заказа | Размеры, мм | | | | | |
|------------|-------------|--------------------|-------------|------|------|------|----|----|
| | | | L | B | C | E | G | F |
| 3 | 1/4 | M3-FC-FBP4- | 35.3 | 12.9 | 12.9 | 2.4 | 12 | 19 |
| 6 | 1/4 | M6-FC-FBP4- | 37.6 | 12.9 | 15.3 | 4.8 | 14 | 19 |
| 6 | 3/8 | M6-FC-FBP6- | 37.6 | 14.2 | 15.3 | 4.8 | 14 | 24 |
| 6 | 1/2 | M6-FC-FBP8- | 43.5 | 18.8 | 15.3 | 4.8 | 14 | 27 |
| 8 | 1/4 | M8-FC-FBP4- | 38.5 | 12.9 | 16.2 | 6.4 | 16 | 19 |
| 8 | 3/8 | M8-FC-FBP6- | 36.2 | 14.2 | 16.2 | 6.4 | 16 | 24 |
| 8 | 1/2 | M8-FC-FBP8- | 41.0 | 18.8 | 16.2 | 6.4 | 16 | 27 |
| 10 | 1/4 | M10-FC-FBP4- | 39.4 | 12.9 | 17.2 | 5.9 | 19 | 19 |
| 10 | 3/8 | M10-FC-FBP6- | 38.8 | 14.2 | 17.2 | 7.9 | 19 | 24 |
| 10 | 1/2 | M10-FC-FBP8- | 42.1 | 18.8 | 17.2 | 7.9 | 19 | 27 |
| 12 | 1/4 | M12-FC-FBP4- | 41.9 | 12.9 | 22.8 | 5.9 | 22 | 22 |
| 12 | 3/8 | M12-FC-FBP6- | 44.4 | 14.2 | 22.8 | 7.9 | 22 | 24 |
| 12 | 1/2 | M12-FC-FBP8- | 48.2 | 18.8 | 22.8 | 9.5 | 22 | 27 |
| 20 | 1/2 | M20-FC-FBP8- | 54.3 | 18.8 | 26.0 | 11.9 | 32 | 30 |
| 22 | 1/2 | M22-FC-FBP8- | 54.3 | 18.8 | 26.0 | 11.9 | 32 | 30 |

Фитинг с внутренней резьбой

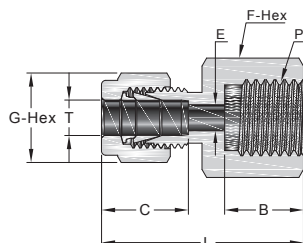

Дюймовая трубка

Метрическая резьба

| Трубка, дюйм | Р-размер метрической резьбы | Артикул для заказа | Размеры, мм | | | | | |
|--------------|-----------------------------|--------------------|-------------|----|------|------|------|------|
| | | | L | B | C | E | G | F |
| 1/8 | M14 x 1.5 | F2-FC-FMS14- | 32.3 | 13 | 12.7 | 2.3 | 11.1 | 19.1 |
| 1/8 | M16 x 1.5 | F2-FC-FMS16- | 33.3 | 14 | 12.7 | 2.3 | 11.1 | 22.2 |
| 1/8 | M18 x 1.5 | F2-FC-FMS18- | 34.3 | 15 | 12.7 | 2.3 | 11.1 | 25.4 |
| 1/8 | M20 x 1.5 | F2-FC-FMS20- | 35.3 | 16 | 12.7 | 2.3 | 11.1 | 27.0 |
| 1/4 | M16 x 1.5 | F4-FC-FMS16- | 35.8 | 14 | 15.2 | 4.8 | 14.3 | 22.2 |
| 1/4 | M18 x 1.5 | F4-FC-FMS18- | 36.8 | 15 | 15.2 | 4.8 | 14.3 | 25.4 |
| 1/4 | M20 x 1.5 | F4-FC-FMS20- | 37.8 | 16 | 15.2 | 4.8 | 14.3 | 27.0 |
| 3/8 | M14 x 1.5 | F6-FC-FMS14- | 37.1 | 13 | 16.8 | 7.1 | 17.5 | 19.1 |
| 3/8 | M16 x 1.5 | F6-FC-FMS16- | 37.5 | 14 | 16.8 | 7.1 | 17.5 | 22.2 |
| 3/8 | M18 x 1.5 | F6-FC-FMS18- | 38.5 | 15 | 16.8 | 7.1 | 17.5 | 25.4 |
| 3/8 | M20 x 1.5 | F6-FC-FMS20- | 39.5 | 16 | 16.8 | 7.1 | 17.5 | 27.0 |
| 1/2 | M16 x 1.5 | F8-FC-FMS16- | 41.4 | 14 | 22.9 | 8.4 | 22.2 | 22.2 |
| 1/2 | M18 x 1.5 | F8-FC-FMS18- | 42.4 | 15 | 22.9 | 9.6 | 22.2 | 25.4 |
| 1/2 | M20 x 1.5 | F8-FC-FMS20- | 43.4 | 16 | 22.9 | 10.4 | 22.2 | 27.0 |
| 1/2 | M22 x 1.5 | F8-FC-FMS22- | 44.4 | 17 | 22.9 | 10.4 | 22.2 | 27.0 |

Метрическая трубка

Метрическая резьба

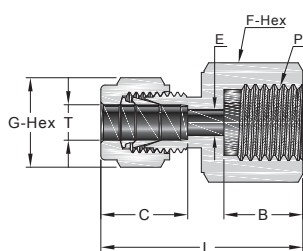

| Трубка, дюйм | Р-размер метрической резьбы | Артикул для заказа | Размеры, мм | | | | | |
|--------------|-----------------------------|--------------------|-------------|----|------|------|----|----|
| | | | L | B | C | E | G | F |
| 6 | M10 x 1 | M6-FC-FMS10- | 32.7 | 11 | 15.3 | 4.0 | 14 | 16 |
| 6 | M14 x 1.5 | M6-FC-FMS14- | 34.7 | 13 | 15.3 | 4.8 | 14 | 19 |
| 6 | M20 x 1.5 | M6-FC-FMS20- | 37.7 | 16 | 15.3 | 4.8 | 14 | 27 |
| 8 | M8 x 1 | M8-FC-FMS8- | 31.6 | 9 | 16.2 | 3.2 | 16 | 14 |
| 8 | M10 x 1 | M8-FC-FMS10- | 33.6 | 11 | 16.2 | 4.0 | 16 | 16 |
| 8 | M14 x 1.5 | M8-FC-FMS14- | 35.6 | 13 | 16.2 | 6.0 | 16 | 19 |
| 8 | M20 x 1.5 | M8-FC-FMS20- | 38.6 | 16 | 16.2 | 6.4 | 16 | 27 |
| 10 | M16 x 1.5 | M10-FC-FMS16- | 38.1 | 14 | 17.2 | 7.9 | 19 | 22 |
| 12 | M20 x 1.5 | M12-FC-FMS20- | 44.9 | 16 | 22.8 | 9.5 | 22 | 27 |
| 14 | M10 x 1 | M14-FC-FMS10- | 42.5 | 11 | 24.4 | 4.0 | 25 | 24 |
| 14 | M20 x 1.5 | M14-FC-FMS20- | 44.9 | 16 | 24.4 | 10.8 | 25 | 27 |
| 14 | M22 x 1.5 | M14-FC-FMS22- | 45.9 | 17 | 24.4 | 11.1 | 25 | 27 |
| 16 | M20 x 1.5 | M16-FC-FMS20- | 44.9 | 16 | 24.4 | 10.8 | 26 | 27 |
| 20 | M20 x 1.5 | M20-FC-FMS20- | 46.5 | 16 | 26.0 | 10.8 | 32 | 30 |
| 25 | M27 x 2 | M25-FC-FMS27- | 54.4 | 18 | 31.3 | 16.1 | 38 | 35 |

Штуцер с внутренней резьбой и монтажом на панель

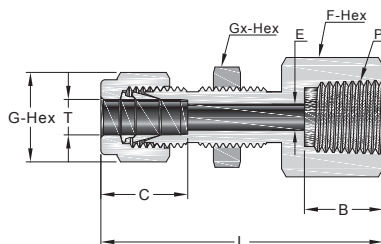

Дюймовая трубка

Резьба NPT

| Трубка, дюйм | P-NPT Резьба | Артикул для заказа | Размеры, мм | | | | | | | Диаметр отверстия в панели, мм | Макс. толщина панели, мм |
|-----------------|-----------------|-----------------------|-------------|------|------|------|------|------|------|--------------------------------------|--------------------------------|
| | | | L | B | C | E | G | F | Gx | | |
| 1/16 | 1/16 | F1-BFC-FNPT1- | 26.2 | 9.9 | 8.6 | 1.3 | 7.9 | 11.1 | 7.9 | 5.2 | 3.2 |
| 1/16 | 1/8 | F1-BFC-FNPT2- | 26.9 | 10.4 | 8.6 | 1.3 | 7.9 | 14.3 | 7.9 | 5.2 | 3.2 |
| 1/8 | 1/8 | F2-BFC-FNPT2- | 44.7 | 10.4 | 12.7 | 2.3 | 11.1 | 14.3 | 12.7 | 8.3 | 12.7 |
| 1/8 | 1/4 | F2-BFC-FNPT4- | 49.6 | 15.0 | 12.7 | 2.3 | 11.1 | 19.1 | 12.7 | 8.3 | 12.7 |
| 3/16 | 1/8 | F3-BFC-FNPT2- | 45.5 | 10.4 | 13.7 | 3.0 | 12.7 | 14.3 | 14.3 | 9.9 | 12.7 |
| 1/4 | 1/8 | F4-BFC-FNPT2- | 47.0 | 10.4 | 15.2 | 4.8 | 14.3 | 15.9 | 15.9 | 11.5 | 10.2 |
| 1/4 | 1/4 | F4-BFC-FNPT4- | 51.8 | 15.0 | 15.2 | 4.8 | 14.3 | 19.1 | 15.9 | 11.5 | 10.2 |
| 1/4 | 3/8 | F4-BFC-FNPT6- | 53.3 | 15.0 | 15.2 | 4.8 | 14.3 | 22.2 | 15.9 | 11.5 | 10.2 |
| 1/4 | 1/2 | F4-BFC-FNPT8- | 58.2 | 19.8 | 15.2 | 4.8 | 14.3 | 27.0 | 15.9 | 11.5 | 10.2 |
| 5/16 | 1/8 | F5-BFC-FNPT2- | 49.8 | 10.4 | 16.3 | 6.4 | 15.9 | 14.3 | 17.5 | 13.1 | 11.2 |
| 5/16 | 1/4 | F5-BFC-FNPT4- | 60.5 | 15.0 | 16.3 | 6.4 | 15.9 | 19.1 | 17.5 | 13.1 | 11.2 |
| 3/8 | 1/8 | F6-BFC-FNPT2- | 50.3 | 10.4 | 16.8 | 7.1 | 17.5 | 15.9 | 19.1 | 14.5 | 11.2 |
| 3/8 | 1/4 | F6-BFC-FNPT4- | 55.1 | 15.0 | 16.8 | 7.1 | 17.5 | 19.1 | 19.1 | 14.5 | 11.2 |
| 3/8 | 3/8 | F6-BFC-FNPT6- | 56.6 | 15.0 | 16.8 | 7.1 | 17.5 | 22.2 | 19.1 | 14.5 | 11.2 |
| 3/8 | 1/2 | F6-BFC-FNPT8- | 61.5 | 19.8 | 16.8 | 7.1 | 17.5 | 27.0 | 19.1 | 14.5 | 11.2 |
| 3/8 | 3/4 | F6-BFC-FNPT12- | 65.3 | 20.6 | 16.8 | 7.1 | 17.5 | 33.3 | 19.1 | 14.5 | 11.2 |
| 1/2 | 1/4 | F8-BFC-FNPT4- | 60.2 | 15.0 | 22.9 | 10.4 | 22.2 | 23.8 | 23.8 | 19.4 | 12.7 |
| 1/2 | 3/8 | F8-BFC-FNPT6- | 61.7 | 15.0 | 22.9 | 10.4 | 22.2 | 23.8 | 23.8 | 19.4 | 12.7 |
| 1/2 | 1/2 | F8-BFC-FNPT8- | 66.5 | 19.8 | 22.9 | 10.4 | 22.2 | 27.0 | 23.8 | 19.4 | 12.7 |
| 1/2 | 3/4 | F8-BFC-FNPT12- | 68.1 | 20.6 | 22.9 | 10.4 | 22.2 | 33.3 | 23.8 | 19.4 | 12.7 |
| 5/8 | 3/8 | F10-BFC-FNPT6- | 62.5 | 15.0 | 24.4 | 12.7 | 25.4 | 23.8 | 27.0 | 22.6 | 15.1 |
| 5/8 | 1/2 | F10-BFC-FNPT8- | 67.3 | 19.8 | 24.4 | 12.7 | 25.4 | 27.0 | 27.0 | 22.6 | 15.1 |
| 3/4 | 1/2 | F12-BFC-FNPT8- | 72.2 | 19.8 | 24.4 | 15.7 | 28.6 | 27.0 | 30.2 | 25.8 | 19.8 |
| 3/4 | 3/4 | F12-BFC-FNPT12- | 73.7 | 20.6 | 24.4 | 15.7 | 28.6 | 33.3 | 30.2 | 25.8 | 19.8 |
| 7/8 | 3/4 | F14-BFC-FNPT12- | 80.8 | 20.6 | 25.9 | 18.3 | 31.8 | 33.3 | 33.3 | 29.0 | 23.8 |
| 1 | 3/4 | F16-BFC-FNPT12- | 84.7 | 20.6 | 31.2 | 22.4 | 38.1 | 41.3 | 41.3 | 33.7 | 23.8 |
| 1 | 1 | F16-BFC-FNPT16- | 93.5 | 25.4 | 31.2 | 22.4 | 38.1 | 41.3 | 41.3 | 33.7 | 23.8 |

Метрическая трубка

Резьба NPT

| Трубка, мм | P-NPT Резьба | Артикул для заказа | Размеры, мм | | | | | | | Диаметр отверстия в панели, мм | Макс. толщина панели, мм |
|---------------|-----------------|-----------------------|-------------|------|------|-----|----|----|----|--------------------------------------|--------------------------------|
| | | | L | B | C | E | G | F | Gx | | |
| 6 | 1/8 | M6-BFC-FNPT2- | 47.2 | 10.4 | 15.3 | 4.8 | 14 | 16 | 16 | 11.5 | 10.2 |
| 6 | 1/4 | M6-BFC-FNPT4- | 51.8 | 15.0 | 15.3 | 4.8 | 14 | 19 | 16 | 11.5 | 10.2 |
| 8 | 1/8 | M8-BFC-FNPT2- | 49.6 | 10.4 | 16.2 | 4.8 | 16 | 18 | 18 | 13.1 | 11.2 |
| 10 | 1/4 | M10-BFC-FNPT4- | 55.2 | 15.0 | 17.2 | 7.9 | 19 | 22 | 22 | 16.3 | 11.2 |
| 12 | 3/8 | M12-BFC-FNPT6- | 60.9 | 15.0 | 22.8 | 9.5 | 22 | 24 | 24 | 19.5 | 12.7 |
| 12 | 1/2 | M12-BFC-FNPT8- | 66.5 | 19.8 | 22.8 | 9.5 | 22 | 27 | 24 | 19.5 | 12.7 |

Муфты

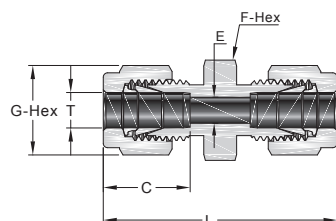

Дюймовая трубка

| Трубка, дюйм | Артикул для заказа | Размеры, мм | | | | |
|--------------|--------------------|-------------|------|------|------|------|
| | | L | C | G | F | E |
| 1/16 | F1-U-F1- | 25.1 | 8.6 | 7.9 | 11.1 | 1.3 |
| 1/8 | F2-U-F2- | 35.6 | 12.7 | 11.1 | 11.1 | 2.3 |
| 3/16 | F3-U-F3- | 37.3 | 13.7 | 12.7 | 12.7 | 3.0 |
| 1/4 | F4-U-F4- | 40.9 | 15.2 | 14.3 | 12.7 | 4.8 |
| 5/16 | F5-U-F5- | 42.9 | 16.2 | 15.9 | 14.3 | 6.4 |
| 3/8 | F6-U-F6- | 45.0 | 16.8 | 17.5 | 15.9 | 7.1 |
| 1/2 | F8-U-F8- | 51.3 | 22.9 | 22.2 | 20.6 | 10.4 |
| 5/8 | F10-U-F10- | 52.1 | 24.4 | 25.4 | 23.9 | 12.7 |
| 3/4 | F12-U-F12- | 53.6 | 24.4 | 28.6 | 27.0 | 15.7 |
| 7/8 | F14-U-F14- | 55.1 | 25.9 | 31.8 | 34.9 | 18.3 |
| 1 | F16-U-F16- | 64.8 | 31.2 | 38.1 | 34.9 | 22.4 |
| 1 1/8 | F18-U-F18- | 64.8 | 31.2 | 44.5 | 41.3 | 24.6 |
| 1 1/4 | F20-U-F20- | 92.2 | 41.1 | 47.6 | 44.5 | 27.7 |
| 1 1/2 | F24-U-F24- | 108 | 50.0 | 57.2 | 54.0 | 34.0 |

Метрическая трубка

| Трубка, мм | Артикул для заказа | Размеры, мм | | | | |
|------------|--------------------|-------------|------|----|----|------|
| | | L | C | G | F | E |
| 2 | M2-U-M2- | 35.6 | 12.9 | 12 | 12 | 1.7 |
| 3 | M3-U-M3- | 35.3 | 12.9 | 12 | 12 | 2.4 |
| 4 | M4-U-M4- | 37.3 | 13.7 | 12 | 12 | 2.4 |
| 6 | M6-U-M6- | 41.0 | 15.3 | 14 | 14 | 4.8 |
| 8 | M8-U-M8- | 43.2 | 16.2 | 16 | 15 | 6.4 |
| 10 | M10-U-M10- | 46.2 | 17.2 | 19 | 18 | 7.9 |
| 12 | M12-U-M12- | 51.2 | 22.8 | 22 | 22 | 9.5 |
| 14 | M14-U-M14- | 52.0 | 24.4 | 25 | 24 | 11.1 |
| 15 | M15-U-M15- | 52.0 | 24.4 | 25 | 24 | 11.9 |
| 16 | M16-U-M16- | 52.0 | 24.4 | 25 | 24 | 12.7 |
| 18 | M18-U-M18- | 53.5 | 24.4 | 30 | 27 | 15.1 |
| 20 | M20-U-M20- | 55.0 | 26.0 | 32 | 30 | 15.9 |
| 22 | M22-U-M22- | 55.0 | 26.0 | 32 | 30 | 18.3 |
| 25 | M25-U-M25- | 65.0 | 31.3 | 38 | 35 | 21.8 |
| 28 | M28-U-M28- | 85.0 | 36.6 | 46 | 41 | 21.8 |
| 30 | M30-U-M30- | 92.7 | 39.6 | 50 | 46 | 26.2 |
| 32 | M32-U-M32- | 97.3 | 42.0 | 50 | 46 | 28.6 |
| 38 | M38-U-M38- | 113.6 | 49.4 | 60 | 55 | 33.7 |

Переходные муфты

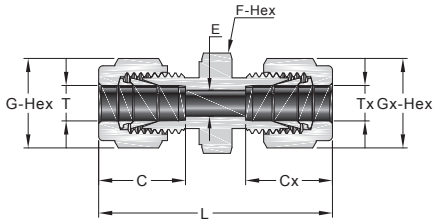

Метрическая трубка

Дюймовая трубка

| Трубка, мм | Трубка, дюйм | Артикул для заказа | Размеры, мм | | | | | | |
|------------|--------------|--------------------|-------------|------|----|----|------|------|------|
| | | | L | C | G | F | E | Cx | Gx |
| 3 | 1/8 | M3-U-F2- | 35.2 | 12.9 | 12 | 12 | 2.4 | 12.7 | 11.1 |
| 4 | 1/8 | M4-U-F2- | 36.5 | 13.7 | 12 | 12 | 2.4 | 12.7 | 11.1 |
| 4 | 1/4 | M4-U-F4- | 39.4 | 13.7 | 12 | 14 | 2.4 | 15.2 | 14.3 |
| 6 | 1/8 | M6-U-F2- | 38.5 | 15.3 | 14 | 14 | 2.4 | 12.7 | 11.1 |
| 6 | 1/4 | M6-U-F4- | 41.0 | 15.3 | 14 | 14 | 4.8 | 15.2 | 14.3 |
| 6 | 5/16 | M6-U-F5- | 42.3 | 15.3 | 14 | 14 | 4.8 | 16.2 | 15.9 |
| 8 | 1/4 | M8-U-F4- | 42.3 | 16.2 | 16 | 15 | 4.8 | 15.2 | 14.3 |
| 8 | 3/8 | M8-U-F6- | 44.3 | 16.2 | 16 | 16 | 6.4 | 16.8 | 17.5 |
| 10 | 1/8 | M10-U-F2- | 41.8 | 17.2 | 19 | 18 | 2.4 | 12.7 | 11.1 |
| 10 | 1/4 | M10-U-F4- | 44.5 | 17.2 | 19 | 18 | 4.8 | 15.2 | 14.3 |
| 10 | 5/16 | M10-U-F5- | 45.1 | 17.2 | 19 | 18 | 6.4 | 16.2 | 15.9 |
| 10 | 3/8 | M10-U-F6- | 45.9 | 17.2 | 19 | 18 | 7.1 | 16.8 | 17.5 |
| 12 | 5/16 | M12-U-F5- | 47.8 | 22.8 | 22 | 22 | 6.4 | 16.2 | 15.9 |
| 12 | 3/8 | M12-U-F6- | 48.4 | 22.8 | 22 | 22 | 7.1 | 16.8 | 17.5 |
| 12 | 1/2 | M12-U-F8- | 51.2 | 22.8 | 22 | 22 | 9.5 | 22.9 | 22.2 |
| 15 | 1/2 | M15-U-F8- | 52.0 | 24.4 | 25 | 24 | 10.4 | 22.9 | 22.2 |
| 16 | 5/8 | M16-U-F10- | 52.0 | 24.4 | 25 | 24 | 12.7 | 24.4 | 25.4 |
| 18 | 3/4 | M18-U-F12- | 53.5 | 24.4 | 30 | 27 | 15.1 | 24.4 | 28.6 |
| 20 | 1/2 | M20-U-F8- | 55.0 | 26.0 | 32 | 30 | 10.4 | 22.9 | 22.2 |
| 20 | 1 | M20-U-F16- | 62.8 | 26.0 | 32 | 35 | 15.9 | 31.2 | 38.1 |
| 25 | 1 | M25-U-F16- | 65.0 | 31.3 | 38 | 35 | 21.8 | 31.2 | 38.1 |

Переходные муфты

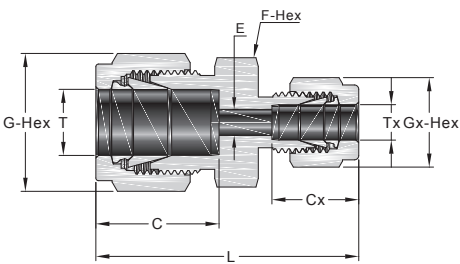

Дюймовая трубка

| Трубка, дюйм | Трубка, дюйм | Артикул для заказа | Размеры, мм | | | | | | |
|--------------|--------------|--------------------|-------------|------|------|------|------|------|------|
| | | | L | C | G | F | E | Cx | Gx |
| 1/8 | 1/16 | F2-U-F1- | 31.0 | 12.7 | 11.1 | 11.1 | 1.3 | 8.6 | 7.9 |
| 3/16 | 1/16 | F3-U-F1- | 32.3 | 13.7 | 12.7 | 11.1 | 1.3 | 8.6 | 7.9 |
| 3/16 | 1/8 | F3-U-F2- | 36.6 | 13.7 | 12.7 | 11.1 | 2.3 | 12.7 | 11.1 |
| 1/4 | 1/16 | F4-U-F1- | 34.3 | 15.2 | 14.3 | 12.7 | 1.3 | 8.6 | 7.9 |
| 1/4 | 1/8 | F4-U-F2- | 38.6 | 15.2 | 14.3 | 12.7 | 2.3 | 12.7 | 11.1 |
| 1/4 | 3/16 | F4-U-F3- | 39.4 | 15.2 | 14.3 | 12.7 | 3.0 | 13.7 | 12.7 |
| 5/16 | 1/8 | F5-U-F2- | 39.6 | 16.2 | 15.9 | 14.3 | 2.3 | 12.7 | 11.1 |
| 5/16 | 1/4 | F5-U-F4- | 42.2 | 16.2 | 15.9 | 14.3 | 4.8 | 15.2 | 14.3 |
| 3/8 | 1/16 | F6-U-F1- | 36.6 | 16.8 | 17.5 | 15.9 | 1.3 | 8.6 | 7.9 |
| 3/8 | 1/8 | F6-U-F2- | 40.9 | 16.8 | 17.5 | 15.9 | 2.3 | 12.7 | 11.1 |
| 3/8 | 1/4 | F6-U-F4- | 43.2 | 16.8 | 17.5 | 15.9 | 4.8 | 15.2 | 14.3 |
| 3/8 | 5/16 | F6-U-F5- | 44.2 | 16.8 | 17.5 | 15.9 | 6.4 | 16.2 | 15.9 |
| 1/2 | 1/8 | F8-U-F2- | 45.2 | 22.8 | 22.2 | 20.6 | 2.3 | 12.7 | 11.1 |
| 1/2 | 1/4 | F8-U-F4- | 47.0 | 22.8 | 22.2 | 20.6 | 4.8 | 15.2 | 14.3 |
| 1/2 | 3/8 | F8-U-F6- | 48.5 | 22.8 | 22.2 | 20.6 | 7.1 | 16.8 | 17.5 |
| 5/8 | 3/8 | F10-U-F6- | 49.3 | 24.4 | 25.4 | 23.9 | 7.1 | 16.8 | 17.5 |
| 5/8 | 1/2 | F10-U-F8- | 52.1 | 24.4 | 25.4 | 23.9 | 10.4 | 22.8 | 22.2 |
| 3/4 | 1/4 | F12-U-F4- | 49.3 | 24.4 | 28.6 | 27.0 | 4.8 | 15.2 | 14.3 |
| 3/4 | 3/8 | F12-U-F6- | 50.8 | 24.4 | 28.6 | 27.0 | 7.1 | 16.8 | 17.5 |
| 3/4 | 1/2 | F12-U-F8- | 53.6 | 24.4 | 28.6 | 27.0 | 10.4 | 22.8 | 22.2 |
| 3/4 | 5/8 | F12-U-F10- | 53.6 | 24.4 | 28.6 | 27.0 | 12.7 | 24.4 | 25.4 |
| 1 | 1/2 | F16-U-F8- | 60.5 | 31.2 | 38.1 | 34.9 | 10.4 | 22.8 | 22.2 |
| 1 | 3/4 | F16-U-F12- | 60.5 | 31.2 | 38.1 | 34.9 | 15.7 | 24.4 | 28.6 |

Переходные муфты

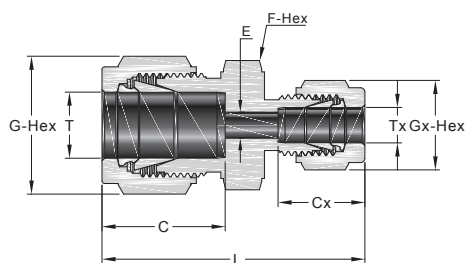

Метрическая трубка

| Трубка, мм | Трубка, мм | Артикул для заказа | Размеры, мм | | | | | | |
|------------|------------|--------------------|-------------|------|----|----|------|------|----|
| | | | L | C | G | F | E | Cx | Gx |
| 3 | 2 | M3-U-M2- | 35.3 | 12.9 | 12 | 12 | 1.7 | 12.9 | 12 |
| 6 | 2 | M6-U-M2- | 38.6 | 15.3 | 14 | 14 | 1.7 | 12.9 | 12 |
| 6 | 3 | M6-U-M3- | 38.6 | 15.3 | 14 | 14 | 2.4 | 12.9 | 12 |
| 6 | 4 | M6-U-M4- | 39.4 | 15.3 | 14 | 14 | 2.4 | 13.7 | 12 |
| 8 | 6 | M8-U-M6- | 42.3 | 16.3 | 16 | 15 | 4.8 | 15.3 | 14 |
| 10 | 6 | M10-U-M6- | 44.5 | 17.2 | 19 | 18 | 4.8 | 15.3 | 14 |
| 10 | 8 | M10-U-M8- | 45.1 | 17.2 | 19 | 18 | 6.4 | 16.3 | 16 |
| 12 | 6 | M12-U-M6- | 47.0 | 22.8 | 22 | 22 | 4.8 | 15.3 | 14 |
| 12 | 8 | M12-U-M8- | 47.8 | 22.8 | 22 | 22 | 6.4 | 16.3 | 16 |
| 12 | 10 | M12-U-M10- | 48.7 | 22.8 | 22 | 22 | 7.9 | 17.2 | 19 |
| 16 | 10 | M16-U-M10- | 49.5 | 24.4 | 25 | 24 | 7.9 | 17.2 | 19 |
| 16 | 12 | M16-U-M12- | 52.0 | 24.4 | 25 | 24 | 9.5 | 22.8 | 22 |
| 18 | 12 | M18-U-M12- | 53.5 | 24.4 | 30 | 27 | 9.5 | 22.8 | 22 |
| 25 | 18 | M25-U-M18- | 61.0 | 31.3 | 38 | 35 | 15.1 | 24.4 | 30 |
| 25 | 20 | M25-U-M20- | 62.3 | 31.3 | 38 | 35 | 15.9 | 26.0 | 32 |
| 30 | 18 | M30-U-M18- | 75.4 | 39.6 | 50 | 46 | 15.1 | 24.4 | 30 |
| 30 | 20 | M30-U-M20- | 75.4 | 39.6 | 50 | 46 | 15.9 | 26.0 | 32 |
| 30 | 25 | M30-U-M25- | 80.1 | 39.6 | 50 | 46 | 21.8 | 31.3 | 38 |
| 32 | 18 | M32-U-M18- | 77.8 | 42.0 | 50 | 46 | 15.1 | 24.4 | 30 |
| 32 | 20 | M32-U-M20- | 77.8 | 42.0 | 50 | 46 | 15.9 | 26.0 | 32 |
| 32 | 25 | M32-U-M25- | 82.3 | 42.0 | 50 | 46 | 21.8 | 31.3 | 38 |
| 38 | 20 | M38-U-M20- | 87.5 | 49.4 | 60 | 55 | 15.9 | 26.0 | 32 |
| 38 | 25 | M38-U-M25- | 92.0 | 49.4 | 60 | 55 | 21.8 | 31.3 | 38 |
| 38 | 30 | M38-U-M30- | 104.6 | 49.4 | 60 | 55 | 26.2 | 39.6 | 50 |

Муфта с монтажом на панель

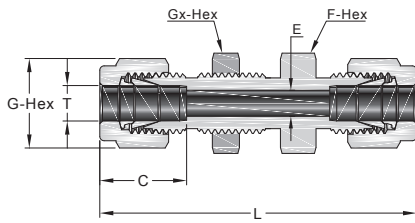

Дюймовая трубка

| Трубка, дюйм | Артикул для заказа | Размеры, мм | | | | | | Диаметр отверстия в панели, мм | Макс. толщина панели, мм |
|--------------|--------------------|-------------|------|------|------|------|------|--------------------------------|--------------------------|
| | | L | C | E | G | F | Gx | | |
| 1/16 | F1-BU-F1- | 31.5 | 8.6 | 1.3 | 7.9 | 7.9 | 7.9 | 5.2 | 3.0 |
| 1/8 | F2-BU-F2- | 51.3 | 12.7 | 2.3 | 11.1 | 12.7 | 12.7 | 8.3 | 12.7 |
| 3/16 | F3-BU-F3- | 53.6 | 13.7 | 3.0 | 12.7 | 14.3 | 14.3 | 9.9 | 12.7 |
| 1/4 | F4-BU-F4- | 57.7 | 15.2 | 4.8 | 14.3 | 15.9 | 15.9 | 11.5 | 10.2 |
| 5/16 | F5-BU-F5- | 60.7 | 16.3 | 6.4 | 15.9 | 17.5 | 17.5 | 13.1 | 11.2 |
| 3/8 | F6-BU-F6- | 62.2 | 16.8 | 7.1 | 17.5 | 19.1 | 19.1 | 14.7 | 11.2 |
| 1/2 | F8-BU-F8- | 71.1 | 22.9 | 10.4 | 22.2 | 23.8 | 23.8 | 19.4 | 12.7 |
| 5/8 | F10-BU-F10- | 72.6 | 24.4 | 12.7 | 25.4 | 27.0 | 27.0 | 22.6 | 12.7 |
| 3/4 | F12-BU-F12- | 79.0 | 24.4 | 15.7 | 28.6 | 30.2 | 30.2 | 25.8 | 16.8 |
| 7/8 | F14-BU-F14- | 84.6 | 25.9 | 18.3 | 31.8 | 34.9 | 34.9 | 29.0 | 19.1 |
| 1 | F16-BU-F16- | 95.8 | 31.2 | 22.4 | 38.1 | 41.3 | 41.3 | 33.7 | 19.1 |
| 1 1/4 | F20-BU-F20- | 123.2 | 41.1 | 27.8 | 47.6 | 47.6 | 47.6 | 41.7 | 19.1 |
| 1 1/2 | F24-BU-F24- | 139.2 | 50.0 | 34.0 | 57.2 | 57.2 | 57.2 | 49.6 | 19.1 |

Метрическая трубка

| Трубка, дюйм | Артикул для заказа | Размеры, мм | | | | | | Диаметр отверстия в панели, мм | Макс. толщина панели, мм |
|--------------|--------------------|-------------|------|------|----|----|----|--------------------------------|--------------------------|
| | | L | C | E | G | F | Gx | | |
| 3 | M3-BU-M3- | 51.3 | 12.9 | 2.4 | 12 | 14 | 14 | 8.3 | 12.7 |
| 4 | M4-BU-M4- | 53.6 | 13.7 | 2.4 | 12 | 14 | 14 | 9.9 | 12.7 |
| 6 | M6-BU-M6- | 57.7 | 15.3 | 4.8 | 14 | 16 | 16 | 11.5 | 10.2 |
| 8 | M8-BU-M8- | 61.0 | 16.2 | 6.4 | 16 | 18 | 18 | 13.1 | 11.2 |
| 10 | M10-BU-M10- | 63.7 | 17.2 | 7.9 | 19 | 22 | 22 | 16.3 | 11.2 |
| 12 | M12-BU-M12- | 71.0 | 22.8 | 9.5 | 22 | 24 | 24 | 19.5 | 12.7 |
| 14 | M14-BU-M14- | 72.5 | 24.4 | 11.1 | 25 | 27 | 27 | 22.5 | 12.7 |
| 15 | M15-BU-M15- | 72.5 | 24.4 | 11.9 | 25 | 27 | 27 | 22.8 | 12.7 |
| 16 | M16-BU-M16- | 72.5 | 24.4 | 12.7 | 25 | 27 | 27 | 22.8 | 12.7 |
| 18 | M18-BU-M18- | 78.9 | 24.4 | 15.1 | 30 | 30 | 30 | 26.0 | 16.8 |
| 20 | M20-BU-M20- | 84.5 | 26.0 | 15.9 | 32 | 35 | 35 | 29.0 | 19.0 |
| 25 | M25-BU-M25- | 96.0 | 31.3 | 21.8 | 38 | 41 | 41 | 34.0 | 19.0 |
| 30 | M30-BU-M30- | 124.0 | 39.6 | 26.2 | 50 | 50 | 50 | 40.5 | 19.0 |
| 32 | M32-BU-M32- | 128.0 | 42.0 | 28.6 | 50 | 50 | 50 | 42.5 | 19.0 |
| 38 | M38-BU-M38- | 145.0 | 49.4 | 33.7 | 60 | 60 | 60 | 50.5 | 19.0 |

Переходная муфта с монтажом на панель

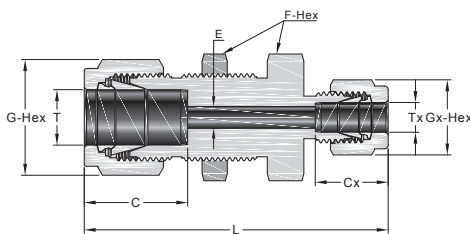

Дюймовая трубка

| Т-Трубка, дюйм | Тх-Трубка, дюйм | Артикул для заказа | Размеры, мм | | | | | | | | Диаметр отверстия в панели, мм | Макс. толщина панели, мм |
|----------------|-----------------|--------------------|-------------|------|-----|------|------|------|------|------|--------------------------------|--------------------------|
| | | | L | C | E | G | F | Cx | Gx | | | |
| 1/4 | 1/8 | F4-BU-F2- | 55.1 | 15.2 | 2.3 | 14.3 | 15.9 | 12.7 | 11.1 | 11.5 | 10.2 | |
| 3/8 | 1/4 | F6-BU-F4- | 60.7 | 16.8 | 4.8 | 17.5 | 19.1 | 15.2 | 14.3 | 14.7 | 11.2 | |
| 1/2 | 1/4 | F8-BU-F4- | 66.8 | 22.9 | 4.8 | 22.2 | 23.8 | 15.2 | 14.3 | 19.4 | 12.7 | |

Bulkhead Reducing Unions

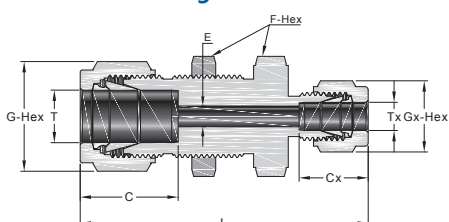

Метрическая трубка

| Т-Трубка, мм | Тх-Трубка, мм | Артикул для заказа | Размеры, мм | | | | | | | | Диаметр отверстия в панели, мм | Макс. толщина панели, мм |
|--------------|---------------|--------------------|-------------|------|-----|----|----|------|----|------|--------------------------------|--------------------------|
| | | | L | C | E | G | F | Cx | Gx | | | |
| 6 | 3 | M6-BU-M3- | 55.1 | 15.3 | 2.4 | 14 | 16 | 12.9 | 12 | 11.5 | 10.2 | |
| 8 | 6 | M8-BU-M6- | 60.1 | 16.2 | 4.8 | 16 | 18 | 15.3 | 14 | 13.1 | 11.2 | |
| 12 | 8 | M12-BU-M8- | 67.6 | 22.8 | 6.4 | 22 | 24 | 16.2 | 16 | 19.5 | 12.7 | |

Угольник с внешней резьбой

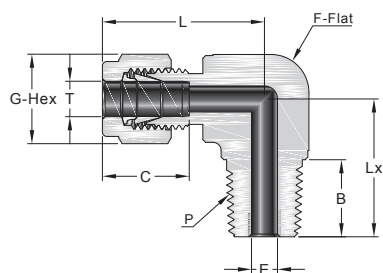

Дюймовая трубка

Резьба NPT

| Трубка, дюйм | P-NPT Резьба | Артикул для заказа | Размеры, мм | | | | | | |
|--------------|--------------|--------------------|-------------|------|------|------|------|------|------|
| | | | L | C | G | F | E | B | Lx |
| 1/16 | 1/16 | F1-ME-NPT1- | 19.1 | 8.6 | 7.9 | 11.1 | 1.3 | 9.7 | 17.8 |
| 1/16 | 1/8 | F1-ME-NPT2- | 19.1 | 8.6 | 7.9 | 11.1 | 1.3 | 9.7 | 17.8 |
| 1/8 | 1/16 | F2-ME-NPT1- | 23.6 | 12.7 | 11.1 | 11.1 | 2.4 | 9.7 | 17.8 |
| 1/8 | 1/8 | F2-ME-NPT2- | 23.6 | 12.7 | 11.1 | 11.1 | 2.4 | 9.7 | 17.8 |
| 1/8 | 1/4 | F2-ME-NPT4- | 24.6 | 12.7 | 11.1 | 12.7 | 2.4 | 14.2 | 23.4 |
| 3/16 | 1/8 | F3-ME-NPT2- | 25.4 | 13.7 | 12.7 | 12.7 | 3.0 | 9.7 | 18.8 |
| 3/16 | 1/4 | F3-ME-NPT4- | 25.4 | 13.7 | 12.7 | 12.7 | 3.0 | 14.2 | 23.4 |
| 1/4 | 1/16 | F4-ME-NPT1- | 26.9 | 15.2 | 14.3 | 12.7 | 3.0 | 9.7 | 18.8 |
| 1/4 | 1/8 | F4-ME-NPT2- | 26.9 | 15.2 | 14.3 | 12.7 | 4.8 | 9.7 | 18.8 |
| 1/4 | 1/4 | F4-ME-NPT4- | 26.9 | 15.2 | 14.3 | 12.7 | 4.8 | 14.2 | 23.4 |
| 1/4 | 3/8 | F4-ME-NPT6- | 29.7 | 15.2 | 14.3 | 17.5 | 4.8 | 14.2 | 26.2 |
| 1/4 | 1/2 | F4-ME-NPT8- | 31.8 | 15.2 | 14.3 | 20.6 | 4.8 | 19.1 | 33.0 |
| 5/16 | 1/8 | F5-ME-NPT2- | 28.7 | 16.3 | 15.9 | 14.3 | 4.8 | 9.7 | 19.8 |
| 5/16 | 1/4 | F5-ME-NPT4- | 28.7 | 16.3 | 15.9 | 14.3 | 6.4 | 14.2 | 24.4 |
| 5/16 | 3/8 | F5-ME-NPT6- | 30.5 | 16.3 | 15.9 | 17.5 | 6.4 | 14.2 | 26.2 |
| 3/8 | 1/8 | F6-ME-NPT2- | 30.5 | 16.8 | 17.5 | 15.9 | 4.8 | 9.7 | 20.8 |
| 3/8 | 1/4 | F6-ME-NPT4- | 30.5 | 16.8 | 17.5 | 15.9 | 7.1 | 14.2 | 25.4 |
| 3/8 | 3/8 | F6-ME-NPT6- | 31.2 | 16.8 | 17.5 | 17.5 | 7.1 | 14.2 | 26.2 |
| 3/8 | 1/2 | F6-ME-NPT8- | 33.3 | 16.8 | 17.5 | 20.6 | 7.1 | 19.1 | 33.0 |
| 3/8 | 3/4 | F6-ME-NPT12- | 37.1 | 16.8 | 17.5 | 27.0 | 7.1 | 19.1 | 36.8 |
| 1/2 | 1/4 | F8-ME-NPT4- | 36.1 | 22.9 | 22.2 | 20.6 | 7.1 | 14.2 | 28.2 |
| 1/2 | 3/8 | F8-ME-NPT6- | 36.1 | 22.9 | 22.2 | 20.6 | 9.7 | 14.2 | 28.2 |
| 1/2 | 1/2 | F8-ME-NPT8- | 36.1 | 22.9 | 22.2 | 20.6 | 10.4 | 19.1 | 33.0 |
| 1/2 | 3/4 | F8-ME-NPT12- | 39.9 | 22.9 | 22.2 | 27.0 | 10.4 | 19.1 | 36.8 |
| 5/8 | 3/8 | F10-ME-NPT6- | 38.1 | 24.4 | 25.4 | 23.8 | 9.7 | 14.2 | 30.2 |
| 5/8 | 1/2 | F10-ME-NPT8- | 38.1 | 24.4 | 25.4 | 23.8 | 11.9 | 19.1 | 35.1 |
| 5/8 | 3/4 | F10-ME-NPT12- | 39.9 | 24.4 | 25.4 | 27.0 | 12.7 | 19.1 | 36.8 |
| 3/4 | 1/2 | F12-ME-NPT8- | 39.9 | 24.4 | 28.6 | 27.0 | 11.9 | 19.1 | 36.8 |
| 3/4 | 3/4 | F12-ME-NPT12- | 39.9 | 24.4 | 28.6 | 27.0 | 15.7 | 19.1 | 36.8 |
| 7/8 | 3/4 | F14-ME-NPT12- | 44.7 | 25.9 | 31.8 | 34.9 | 15.7 | 19.1 | 41.7 |
| 1 | 3/4 | F16-ME-NPT12- | 49.0 | 31.2 | 38.1 | 34.9 | 15.7 | 19.1 | 41.7 |
| 1 | 1 | F16-ME-NPT16- | 49.0 | 31.2 | 38.1 | 34.9 | 22.4 | 23.9 | 46.5 |
| 1 1/4 | 1 1/4 | F20-ME-NPT20- | 66.5 | 41.1 | 47.6 | 42.9 | 27.7 | 23.9 | 52.4 |
| 1 1/2 | 1 1/2 | F24-ME-NPT24- | 78.0 | 50.0 | 57.2 | 50.8 | 34.0 | 26.2 | 60.5 |

Угольник с внешней резьбой

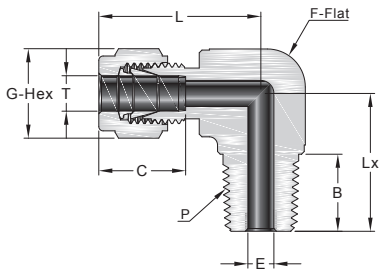

Метрическая трубка

Резьба NPT

| Трубка, мм | P-NPT Резьба | Артикул для заказа | Размеры, мм | | | | | | |
|------------|--------------|--------------------|-------------|------|----|------|------|------|------|
| | | | L | C | G | F | E | B | Lx |
| 3 | 1/8 | M3-ME-NPT2- | 23.6 | 12.9 | 12 | 11.1 | 2.4 | 9.7 | 17.8 |
| 3 | 1/4 | M3-ME-NPT4- | 24.6 | 12.9 | 12 | 12.7 | 2.4 | 14.2 | 23.4 |
| 4 | 1/8 | M4-ME-NPT2- | 25.4 | 13.7 | 12 | 12.7 | 2.4 | 9.7 | 18.8 |
| 4 | 1/4 | M4-ME-NPT4- | 25.4 | 13.7 | 12 | 12.7 | 2.4 | 14.2 | 23.4 |
| 6 | 1/8 | M6-ME-NPT2- | 27.0 | 15.3 | 14 | 12.7 | 4.8 | 9.7 | 18.8 |
| 6 | 1/4 | M6-ME-NPT4- | 27.0 | 15.3 | 14 | 12.7 | 4.8 | 14.2 | 23.4 |
| 6 | 3/8 | M6-ME-NPT6- | 29.8 | 15.3 | 14 | 17.5 | 4.8 | 14.2 | 26.2 |
| 6 | 1/2 | M6-ME-NPT8- | 31.8 | 15.3 | 14 | 20.6 | 4.8 | 19.0 | 33.0 |
| 8 | 1/8 | M8-ME-NPT2- | 28.8 | 16.2 | 16 | 14.3 | 4.8 | 9.7 | 19.8 |
| 8 | 1/4 | M8-ME-NPT4- | 28.8 | 16.2 | 16 | 14.3 | 6.4 | 14.2 | 24.4 |
| 8 | 3/8 | M8-ME-NPT6- | 30.6 | 16.2 | 16 | 17.5 | 6.4 | 14.2 | 26.2 |
| 8 | 1/2 | M8-ME-NPT8- | 32.6 | 16.2 | 16 | 20.6 | 6.4 | 19.1 | 33.0 |
| 10 | 1/8 | M10-ME-NPT2- | 31.5 | 17.2 | 19 | 17.5 | 4.8 | 9.7 | 21.6 |
| 10 | 1/4 | M10-ME-NPT4- | 31.5 | 17.2 | 19 | 17.5 | 7.1 | 14.2 | 26.2 |
| 10 | 3/8 | M10-ME-NPT6- | 31.5 | 17.2 | 19 | 17.5 | 7.9 | 14.2 | 26.2 |
| 10 | 1/2 | M10-ME-NPT8- | 33.5 | 17.2 | 19 | 20.6 | 7.9 | 19.1 | 33.0 |
| 12 | 1/8 | M12-ME-NPT2- | 36.0 | 22.8 | 22 | 20.6 | 4.8 | 9.7 | 23.6 |
| 12 | 1/4 | M12-ME-NPT4- | 36.0 | 22.8 | 22 | 20.6 | 7.1 | 14.2 | 28.2 |
| 12 | 3/8 | M12-ME-NPT6- | 36.0 | 22.8 | 22 | 20.6 | 9.5 | 14.2 | 28.2 |
| 12 | 1/2 | M12-ME-NPT8- | 36.0 | 22.8 | 22 | 20.6 | 9.5 | 19.1 | 33.0 |
| 12 | 3/4 | M12-ME-NPT12- | 39.8 | 22.8 | 22 | 27.0 | 9.5 | 19.1 | 36.8 |
| 15 | 1/2 | M15-ME-NPT8- | 38.0 | 24.4 | 25 | 23.8 | 11.9 | 19.1 | 35.1 |
| 16 | 1/4 | M16-ME-NPT4- | 38.0 | 24.4 | 25 | 23.8 | 7.1 | 14.2 | 30.2 |
| 16 | 3/8 | M16-ME-NPT6- | 38.0 | 24.4 | 25 | 23.8 | 9.5 | 14.2 | 30.2 |
| 16 | 1/2 | M16-ME-NPT8- | 38.0 | 24.4 | 25 | 23.8 | 11.9 | 19.1 | 35.1 |
| 16 | 3/4 | M16-ME-NPT12- | 39.8 | 24.4 | 25 | 27.0 | 12.7 | 19.1 | 36.8 |
| 18 | 1/2 | M18-ME-NPT8- | 39.8 | 24.4 | 30 | 27.0 | 11.9 | 19.1 | 36.8 |
| 18 | 3/4 | M18-ME-NPT12- | 39.8 | 24.4 | 30 | 27.0 | 15.1 | 19.1 | 36.8 |
| 20 | 1/2 | M20-ME-NPT8- | 44.6 | 26.0 | 32 | 34.9 | 11.9 | 19.1 | 41.7 |
| 20 | 3/4 | M20-ME-NPT12- | 44.6 | 26.0 | 32 | 34.9 | 15.9 | 19.1 | 41.7 |
| 22 | 3/4 | M22-ME-NPT12- | 44.6 | 26.0 | 32 | 34.9 | 15.9 | 19.1 | 41.7 |
| 22 | 1 | M22-ME-NPT16- | 44.6 | 26.0 | 32 | 34.9 | 18.3 | 23.9 | 46.5 |
| 25 | 3/4 | M25-ME-NPT12- | 49.1 | 31.3 | 38 | 34.9 | 15.9 | 19.0 | 41.7 |
| 25 | 1 | M25-ME-NPT16- | 49.1 | 31.3 | 38 | 34.9 | 21.8 | 23.9 | 46.5 |
| 30 | 1 1/4 | M30-ME-NPT20- | 69.9 | 39.6 | 50 | 42.9 | 26.2 | 23.9 | 53.1 |
| 32 | 1 1/4 | M32-ME-NPT20- | 72.3 | 42.0 | 50 | 42.9 | 27.8 | 23.9 | 53.1 |
| 38 | 1 1/2 | M38-ME-NPT24- | 84.0 | 49.4 | 60 | 50.8 | 33.7 | 26.2 | 60.4 |

Угольник с внешней резьбой

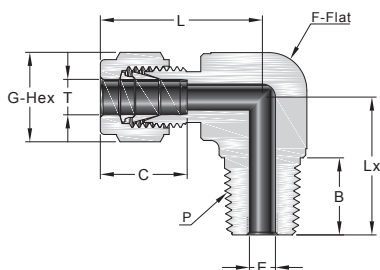

Дюймовая трубка

Коническая резьба ISO (BSPT)

| Трубка, дюйм | P-BSPT Резьба | Артикул для заказа | Размеры, мм | | | | | | |
|--------------|---------------|--------------------|-------------|------|------|------|------|------|------|
| | | | L | C | G | F | E | B | Lx |
| 1/8 | 1/8 | F2-ME-MBT2- | 23.6 | 12.7 | 11.1 | 11.1 | 2.4 | 9.7 | 17.8 |
| 1/8 | 1/4 | F2-ME-MBT4- | 24.6 | 12.7 | 11.1 | 12.7 | 2.4 | 14.2 | 23.4 |
| 1/4 | 1/8 | F4-ME-MBT2- | 26.9 | 15.2 | 14.3 | 12.7 | 4.8 | 9.7 | 18.8 |
| 1/4 | 1/4 | F4-ME-MBT4- | 26.9 | 15.2 | 14.3 | 12.7 | 4.8 | 14.2 | 23.4 |
| 1/4 | 3/8 | F4-ME-MBT6- | 29.7 | 15.2 | 14.3 | 17.5 | 4.8 | 14.2 | 26.2 |
| 1/4 | 1/2 | F4-ME-MBT8- | 31.8 | 15.2 | 14.3 | 20.6 | 4.8 | 19.1 | 33.0 |
| 5/16 | 1/4 | F5-ME-MBT4- | 28.7 | 16.3 | 15.9 | 14.3 | 6.4 | 14.2 | 24.4 |
| 3/8 | 1/8 | F6-ME-MBT2- | 30.5 | 16.8 | 17.5 | 15.9 | 4.8 | 9.7 | 20.8 |
| 3/8 | 1/4 | F6-ME-MBT4- | 30.5 | 16.8 | 17.5 | 15.9 | 7.1 | 14.2 | 25.4 |
| 3/8 | 3/8 | F6-ME-MBT6- | 31.2 | 16.8 | 17.5 | 17.5 | 7.1 | 14.2 | 26.2 |
| 1/2 | 3/8 | F8-ME-MBT6- | 36.1 | 22.9 | 22.2 | 20.6 | 9.7 | 14.2 | 27.9 |
| 1/2 | 1/2 | F8-ME-MBT8- | 36.1 | 22.9 | 22.2 | 20.6 | 10.4 | 19.1 | 33.0 |
| 3/4 | 1/2 | F12-ME-MBT8- | 39.9 | 24.4 | 28.6 | 27.0 | 11.9 | 19.1 | 36.8 |
| 1 | 1 | F16-ME-MBT16- | 49.0 | 31.2 | 38.1 | 34.9 | 22.4 | 23.9 | 46.5 |

Метрическая трубка

Коническая резьба ISO (BSPT)

| Трубка, мм | P-BSPT Резьба | Артикул для заказа | Размеры, мм | | | | | | |
|------------|---------------|--------------------|-------------|------|----|------|------|------|------|
| | | | L | C | G | F | E | B | Lx |
| 3 | 1/8 | M3-ME-MBT2- | 23.6 | 12.9 | 12 | 11.1 | 2.4 | 9.7 | 17.8 |
| 3 | 1/4 | M3-ME-MBT4- | 24.6 | 12.9 | 12 | 12.7 | 2.4 | 14.2 | 23.4 |
| 4 | 1/8 | M4-ME-MBT2- | 25.4 | 13.7 | 12 | 12.7 | 2.4 | 9.7 | 18.8 |
| 4 | 1/4 | M4-ME-MBT4- | 25.4 | 13.7 | 12 | 12.7 | 2.4 | 14.2 | 23.4 |
| 6 | 1/8 | M6-ME-MBT2- | 27.0 | 15.3 | 14 | 12.7 | 4.8 | 9.7 | 18.8 |
| 6 | 1/4 | M6-ME-MBT4- | 27.0 | 15.3 | 14 | 12.7 | 4.8 | 14.2 | 23.4 |
| 6 | 3/8 | M6-ME-MBT6- | 29.8 | 15.3 | 14 | 17.5 | 4.8 | 14.2 | 26.2 |
| 6 | 1/2 | M6-ME-MBT8- | 31.8 | 15.3 | 14 | 20.6 | 4.8 | 19.0 | 33.0 |
| 8 | 1/8 | M8-ME-MBT2- | 28.8 | 16.2 | 16 | 14.3 | 4.8 | 9.7 | 19.8 |
| 8 | 1/4 | M8-ME-MBT4- | 28.8 | 16.2 | 16 | 14.3 | 6.4 | 14.2 | 24.4 |
| 8 | 3/8 | M8-ME-MBT6- | 30.6 | 16.2 | 16 | 17.5 | 6.4 | 14.2 | 26.2 |
| 8 | 1/2 | M8-ME-MBT8- | 32.6 | 16.2 | 16 | 20.6 | 6.4 | 19.1 | 33.0 |
| 10 | 1/8 | M10-ME-MBT2- | 31.5 | 17.2 | 19 | 17.5 | 4.8 | 9.7 | 21.6 |
| 10 | 1/4 | M10-ME-MBT4- | 31.5 | 17.2 | 19 | 17.5 | 7.1 | 14.2 | 26.2 |
| 10 | 3/8 | M10-ME-MBT6- | 31.5 | 17.2 | 19 | 17.5 | 7.9 | 14.2 | 26.2 |
| 10 | 1/2 | M10-ME-MBT8- | 33.5 | 17.2 | 19 | 20.6 | 7.9 | 19.1 | 33.0 |
| 12 | 1/8 | M12-ME-MBT2- | 36.0 | 22.8 | 22 | 20.6 | 4.8 | 9.7 | 23.6 |
| 12 | 1/4 | M12-ME-MBT4- | 36.0 | 22.8 | 22 | 20.6 | 7.1 | 14.2 | 28.2 |
| 12 | 3/8 | M12-ME-MBT6- | 36.0 | 22.8 | 22 | 20.6 | 9.5 | 14.2 | 28.2 |
| 12 | 1/2 | M12-ME-MBT8- | 36.0 | 22.8 | 22 | 20.6 | 9.5 | 19.1 | 33.0 |
| 12 | 3/4 | M12-ME-MBT12- | 39.8 | 22.8 | 22 | 27.0 | 9.5 | 19.1 | 36.8 |
| 14 | 1/2 | M14-ME-MBT8- | 38.1 | 24.4 | 25 | 23.8 | 11.1 | 19.1 | 35.1 |
| 15 | 1/2 | M15-ME-MBT8- | 38.1 | 24.4 | 25 | 23.8 | 11.9 | 19.1 | 35.1 |
| 16 | 1/4 | M16-ME-MBT4- | 38.0 | 24.4 | 25 | 23.8 | 7.1 | 14.2 | 30.2 |
| 16 | 3/8 | M16-ME-MBT6- | 38.0 | 24.4 | 25 | 23.8 | 9.5 | 14.2 | 30.2 |
| 16 | 1/2 | M16-ME-MBT8- | 38.0 | 24.4 | 25 | 23.8 | 11.9 | 19.1 | 35.1 |
| 16 | 3/4 | M16-ME-MBT12- | 39.8 | 24.4 | 25 | 27.0 | 12.7 | 19.1 | 36.8 |
| 18 | 1/2 | M18-ME-MBT8- | 39.8 | 24.4 | 30 | 27.0 | 11.9 | 19.1 | 36.8 |
| 18 | 3/4 | M18-ME-MBT12- | 39.8 | 24.4 | 30 | 27.0 | 15.1 | 19.1 | 36.8 |
| 20 | 1/2 | M20-ME-MBT8- | 44.6 | 26.0 | 32 | 34.9 | 11.9 | 19.1 | 41.7 |
| 20 | 3/4 | M20-ME-MBT12- | 44.6 | 26.0 | 32 | 34.9 | 15.9 | 19.1 | 41.7 |
| 22 | 3/4 | M22-ME-MBT12- | 44.6 | 26.0 | 32 | 34.9 | 15.9 | 19.1 | 41.7 |
| 22 | 1 | M22-ME-MBT16- | 44.6 | 26.0 | 32 | 34.9 | 18.3 | 23.9 | 46.5 |
| 25 | 3/4 | M25-ME-MBT12- | 49.1 | 31.3 | 38 | 34.9 | 15.9 | 19.1 | 41.7 |
| 25 | 1 | M25-ME-MBT16- | 49.1 | 31.3 | 38 | 34.9 | 21.8 | 23.9 | 46.5 |
| 28 | 1 | M28-ME-MBT16- | 64.0 | 36.6 | 46 | 42.9 | 21.8 | 23.9 | 53.1 |

Угольник под 45° с внешней резьбой

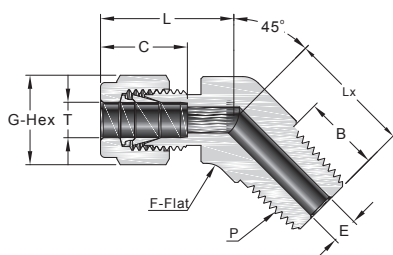

Дюймовая трубка

Резьба NPT

| Трубка, дюйм | P-NPT Резьба | Артикул для заказа | Размеры, мм | | | | | | |
|--------------|--------------|--------------------|-------------|------|------|------|------|------|------|
| | | | L | C | G | F | E | B | Lx |
| 1/16 | 1/16 | F1-45ME-NPT1- | 15.7 | 8.6 | 7.9 | 9.5 | 1.3 | 9.7 | 14.5 |
| 1/8 | 1/8 | F2-45ME-NPT2- | 20.8 | 12.7 | 11.1 | 11.1 | 2.3 | 9.7 | 16.8 |
| 3/16 | 1/8 | F3-45ME-NPT2- | 21.6 | 13.7 | 12.7 | 11.1 | 3.0 | 9.7 | 14.7 |
| 1/4 | 1/8 | F4-45ME-NPT2- | 24.6 | 15.2 | 14.3 | 12.7 | 4.8 | 9.7 | 16.5 |
| 1/4 | 1/4 | F4-45ME-NPT4- | 24.6 | 15.2 | 14.3 | 12.7 | 4.8 | 14.3 | 21.1 |
| 5/16 | 1/8 | F5-45ME-NPT2- | 24.1 | 16.3 | 15.9 | 14.3 | 4.8 | 9.7 | 16.8 |
| 3/8 | 1/8 | F6-45ME-NPT2- | 27.9 | 16.8 | 17.5 | 15.9 | 4.8 | 9.7 | 18.3 |
| 3/8 | 1/4 | F6-45ME-NPT4- | 27.9 | 16.8 | 17.5 | 15.9 | 7.1 | 14.3 | 22.9 |
| 3/8 | 3/8 | F6-45ME-NPT6- | 29.2 | 16.8 | 17.5 | 20.6 | 7.1 | 19.1 | 24.1 |
| 1/2 | 3/8 | F8-45ME-NPT6- | 32.0 | 22.9 | 22.2 | 20.6 | 9.7 | 19.1 | 24.1 |
| 5/8 | 1/2 | F10-45ME-NPT8- | 30.7 | 24.4 | 25.4 | 23.8 | 11.9 | 19.1 | 29.7 |
| 3/4 | 3/4 | F12-45ME-NPT12- | 34.0 | 24.4 | 28.6 | 27.0 | 15.7 | 19.1 | 31.0 |
| 7/8 | 3/4 | F14-45ME-NPT12- | 40.4 | 25.9 | 31.8 | 31.8 | 15.7 | 19.1 | 32.3 |
| 1 | 1 | F16-45ME-NPT16- | 40.4 | 31.2 | 38.1 | 34.9 | 22.4 | 23.9 | 37.8 |

Метрическая трубка

Резьба NPT

| Трубка, мм | P-NPT Резьба | Артикул для заказа | Размеры, мм | | | | | | |
|------------|--------------|--------------------|-------------|------|----|------|------|------|------|
| | | | L | C | G | F | E | B | Lx |
| 6 | 1/8 | M6-45ME-NPT2- | 23.4 | 15.3 | 14 | 12.7 | 4.8 | 9.7 | 16.8 |
| 6 | 1/4 | M6-45ME-NPT4- | 23.4 | 15.3 | 14 | 12.7 | 4.8 | 14.3 | 21.8 |
| 8 | 1/8 | M8-45ME-NPT2- | 24.3 | 16.2 | 16 | 15.9 | 4.8 | 9.7 | 16.8 |
| 10 | 1/4 | M10-45ME-NPT4- | 26.6 | 17.2 | 19 | 17.5 | 7.9 | 14.3 | 24.1 |
| 12 | 3/8 | M12-45ME-NPT6- | 29.1 | 22.8 | 22 | 20.6 | 9.5 | 19.1 | 24.1 |
| 12 | 1/2 | M12-45ME-NPT8- | 30.7 | 22.8 | 22 | 20.6 | 9.5 | 19.1 | 29.7 |
| 16 | 1/2 | M16-45ME-NPT8- | 30.7 | 24.4 | 25 | 23.8 | 11.9 | 19.1 | 29.7 |

Позиционируемый угольник с внешней резьбой

Прямая резьба SAE/MS

Адаптер по стандартам SAE J1926-1, ISO 11926-1 и MS 16142.

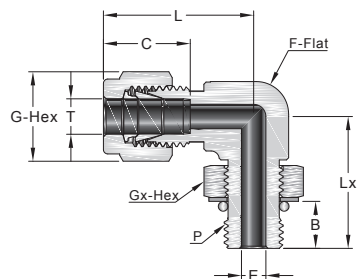

Дюймовая трубка

Прямая резьба SAE/MS

| Трубка, дюйм | P-SAE/MS Резьба | Артикул для заказа | Размеры, мм | | | | | | | |
|--------------|-----------------|--------------------|-------------|------|------|------|------|------|------|------|
| | | | L | B | C | G | E | F | Lx | Gx |
| 1/4 | 7/16-20 | F4-PME-PST7- | 28.4 | 9.9 | 15.2 | 14.3 | 4.8 | 12.7 | 28.4 | 14.3 |
| 1/4 | 9/16-18 | F4-PME-PST9- | 30.5 | 11.2 | 15.2 | 14.3 | 4.8 | 15.9 | 32.3 | 17.5 |
| 5/16 | 1/2-20 | F5-PME-PST8- | 30.2 | 9.9 | 16.3 | 15.9 | 5.8 | 14.3 | 29.5 | 15.9 |
| 3/8 | 7/16-20 | F6-PME-PST7- | 33.3 | 9.9 | 16.8 | 17.5 | 5.1 | 15.9 | 31.5 | 14.3 |
| 3/8 | 9/16-18 | F6-PME-PST9- | 32.0 | 11.2 | 16.8 | 17.5 | 7.1 | 15.9 | 32.3 | 17.5 |
| 3/8 | 3/4-16 | F6-PME-PST12- | 34.8 | 12.7 | 16.8 | 17.5 | 7.1 | 20.6 | 37.8 | 22.2 |
| 1/2 | 9/16-18 | F8-PME-PST9- | 37.6 | 11.2 | 22.9 | 22.2 | 7.1 | 20.6 | 37.5 | 17.5 |
| 1/2 | 3/4-16 | F8-PME-PST12- | 37.6 | 12.7 | 22.9 | 22.2 | 10.4 | 20.6 | 37.8 | 22.2 |
| 5/8 | 7/8-14 | F10-PME-PST14- | 39.6 | 14.2 | 24.4 | 25.4 | 12.7 | 23.8 | 43.4 | 25.4 |
| 3/4 | 1 1/16-12 | F12-PME-PST17- | 41.4 | 16.8 | 24.4 | 28.6 | 15.7 | 27.0 | 48.8 | 31.8 |
| 7/8 | 1 3/16-12 | F14-PME-PST19- | 43.2 | 16.8 | 25.9 | 31.8 | 18.3 | 30.2 | 50.5 | 34.9 |
| 1 | 1 5/16-12 | F16-PME-PST21- | 50.5 | 16.8 | 31.2 | 38.1 | 22.4 | 34.9 | 53.6 | 38.1 |
| 1 1/4 | 1 5/8-12 | F20-PME-PST26- | 67.8 | 16.8 | 41.1 | 47.6 | 27.7 | 42.9 | 58.2 | 47.6 |
| 1 1/2 | 1 7/8-12 | F24-PME-PST30- | 78.0 | 16.8 | 50.0 | 57.2 | 34.0 | 50.8 | 60.5 | 54.0 |

Позиционируемый угольник с внешней резьбой

Цилиндрическая резьба ISO

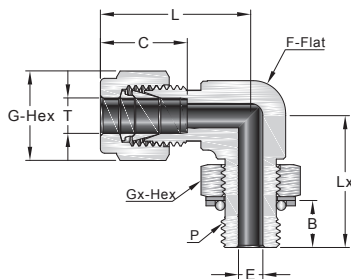

Дюймовая трубка

Цилиндрическая резьба ISO (PPT)

| Трубка, дюйм | P-ISO Цилиндри- ческая резьба | Артикул для заказа | Размеры, мм | | | | | | | |
|--------------|-------------------------------------|-----------------------|-------------|------|------|------|------|------|------|------|
| | | | L | B | C | G | E | F | Lx | Gx |
| 1/4 | 1/8 | F4-PME-PPT2- | 26.9 | 8.1 | 15.2 | 14.3 | 4.1 | 12.7 | 26.4 | 14.3 |
| 1/4 | 1/4 | F4-PME-PPT4- | 29.0 | 9.1 | 15.2 | 14.3 | 4.8 | 15.9 | 32.3 | 19.1 |
| 3/8 | 1/4 | F6-PME-PPT4- | 30.5 | 9.1 | 16.8 | 17.5 | 5.8 | 15.9 | 32.3 | 19.1 |
| 3/8 | 3/8 | F6-PME-PPT6- | 33.3 | 9.4 | 16.8 | 17.5 | 7.1 | 20.6 | 37.1 | 22.2 |
| 1/2 | 1/4 | F8-PME-PPT4- | 36.1 | 9.1 | 22.9 | 22.2 | 5.8 | 20.6 | 35.1 | 19.1 |
| 1/2 | 3/8 | F8-PME-PPT6- | 36.1 | 9.4 | 22.9 | 22.2 | 7.9 | 20.6 | 37.1 | 22.2 |
| 1/2 | 1/2 | F8-PME-PPT8- | 38.1 | 13.0 | 22.9 | 22.2 | 10.4 | 23.8 | 43.4 | 27.0 |
| 5/8 | 1/2 | F10-PME-PPT8- | 38.1 | 13.0 | 24.4 | 25.4 | 11.9 | 23.8 | 43.4 | 27.0 |
| 3/4 | 1/2 | F12-PME-PPT8- | 39.9 | 13.0 | 24.4 | 28.6 | 11.9 | 27.0 | 45.2 | 27.0 |
| 3/4 | 3/4 | F12-PME-PPT12- | 39.9 | 13.0 | 24.4 | 28.6 | 15.7 | 27.0 | 48.8 | 34.9 |
| 1 | 3/4 | F16-PME-PPT12- | 49.0 | 13.0 | 31.2 | 38.1 | 15.7 | 34.9 | 53.3 | 34.9 |
| 1 | 1 | F16-PME-PPT16- | 49.0 | 14.0 | 31.2 | 38.1 | 19.8 | 34.9 | 53.6 | 41.3 |

Метрическая трубка

Цилиндрическая резьба ISO (PPT)

| Трубка, мм | P-ISO Цилиндри- ческая резьба | Артикул для заказа | Размеры, мм | | | | | | | |
|------------|-------------------------------------|-----------------------|-------------|------|------|----|-----|------|------|------|
| | | | L | B | C | G | E | F | Lx | Gx |
| 6 | 1/8 | M6-PME-PPT2- | 27.0 | 8.1 | 15.3 | 14 | 4.0 | 12.7 | 26.4 | 14.3 |
| 6 | 1/4 | M6-PME-PPT4- | 29.0 | 9.1 | 15.3 | 14 | 4.8 | 15.9 | 32.3 | 19.1 |
| 8 | 1/8 | M8-PME-PPT2- | 28.8 | 8.1 | 16.2 | 16 | 4.0 | 14.3 | 27.4 | 14.3 |
| 8 | 1/4 | M8-PME-PPT4- | 29.9 | 9.1 | 16.2 | 16 | 5.9 | 15.9 | 32.2 | 19.1 |
| 10 | 1/4 | M10-PME-PPT4- | 33.5 | 9.1 | 17.2 | 19 | 5.9 | 20.6 | 35.0 | 19.1 |
| 10 | 3/8 | M10-PME-PPT6- | 33.5 | 9.4 | 17.2 | 19 | 7.9 | 20.6 | 37.1 | 22.2 |
| 12 | 1/4 | M12-PME-PPT4- | 36.0 | 9.1 | 22.8 | 22 | 5.9 | 20.6 | 35.0 | 19.1 |
| 12 | 3/8 | M12-PME-PPT6- | 36.0 | 9.4 | 22.8 | 22 | 7.9 | 20.6 | 37.1 | 22.2 |
| 12 | 1/2 | M12-PME-PPT8- | 38.0 | 13.0 | 22.8 | 22 | 9.5 | 23.8 | 43.4 | 27.0 |
| 12 | 3/4 | M12-PME-PPT12- | 39.8 | 13.0 | 22.8 | 22 | 9.5 | 27.0 | 48.8 | 34.9 |

Позиционируемый угольник под 45° с внешней резьбой

Прямая резьба SAE/MS

Адаптер по стандартам SAE J1926-1, ISO 11926-1 и MS 16142.

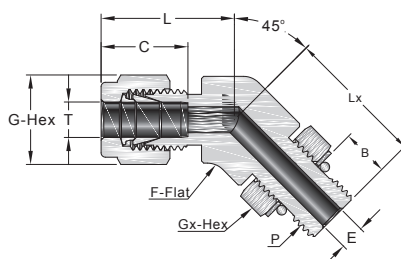

Дюймовая трубка

Прямая резьба SAE/MS

| Трубка, дюйм | P-SAE/MS Резьба | Артикул для заказа | Размеры, мм | | | | | | | |
|--------------|-----------------|--------------------|-------------|------|------|------|------|------|------|------|
| | | | L | B | C | G | E | F | Lx | Gx |
| 1/4 | 7/16-20 | F4-45PME-PST7- | 25.7 | 9.9 | 15.2 | 14.3 | 4.8 | 12.7 | 25.7 | 14.3 |
| 3/8 | 9/16-18 | F6-45PME-PST9- | 27.9 | 11.2 | 16.8 | 17.5 | 7.1 | 15.9 | 28.2 | 17.5 |
| 1/2 | 3/4-16 | F8-45PME-PST12- | 32.0 | 12.7 | 22.9 | 22.2 | 10.4 | 20.6 | 32.3 | 22.2 |
| 3/4 | 1 1/16-12 | F12-45PME-PST17- | 39.9 | 16.8 | 24.4 | 28.6 | 15.7 | 27.0 | 47.2 | 31.8 |
| 1 | 1 5/16-12 | F16-45PME-PST21- | 47.5 | 16.8 | 31.2 | 38.1 | 22.4 | 33.3 | 50.5 | 38.1 |

Угольник с внутренней резьбой

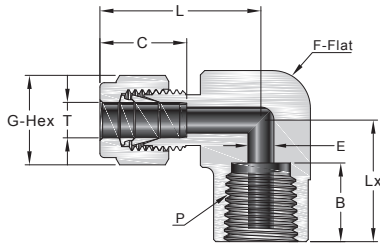

Дюймовая трубка

Резьба NPT

| Трубка, дюйм | P-NPT Резьба | Артикул для заказа | Размеры, мм | | | | | | |
|--------------|--------------|--------------------|-------------|------|------|------|------|------|------|
| | | | L | B | C | G | E | F | Lx |
| 1/16 | 1/16 | F1-FE-FNPT1- | 18.0 | 9.9 | 8.6 | 7.9 | 1.3 | 11.1 | 14.2 |
| 1/16 | 1/8 | F1-FE-FNPT2- | 20.6 | 10.4 | 8.6 | 7.9 | 1.3 | 14.3 | 19.1 |
| 1/8 | 1/8 | F2-FE-FNPT2- | 24.6 | 10.4 | 12.7 | 11.1 | 2.3 | 14.3 | 19.1 |
| 1/8 | 1/4 | F2-FE-FNPT4- | 27.4 | 15.0 | 12.7 | 11.1 | 2.3 | 17.5 | 22.4 |
| 3/16 | 1/8 | F3-FE-FNPT2- | 25.4 | 10.4 | 13.7 | 12.7 | 3.0 | 12.7 | 19.1 |
| 1/4 | 1/8 | F4-FE-FNPT2- | 26.9 | 10.4 | 15.2 | 14.3 | 4.8 | 14.3 | 19.1 |
| 1/4 | 1/4 | F4-FE-FNPT4- | 29.7 | 15.0 | 15.2 | 14.3 | 4.8 | 17.5 | 22.4 |
| 1/4 | 3/8 | F4-FE-FNPT6- | 31.8 | 15.0 | 15.2 | 14.3 | 4.8 | 20.6 | 22.4 |
| 1/4 | 1/2 | F4-FE-FNPT8- | 34.5 | 19.8 | 15.2 | 14.3 | 4.8 | 25.4 | 28.4 |
| 5/16 | 1/8 | F5-FE-FNPT2- | 28.7 | 10.4 | 16.3 | 15.9 | 6.4 | 14.3 | 19.1 |
| 5/16 | 1/4 | F5-FE-FNPT4- | 30.5 | 15.0 | 16.3 | 15.9 | 6.4 | 17.5 | 22.4 |
| 3/8 | 1/8 | F6-FE-FNPT2- | 30.5 | 10.4 | 16.8 | 17.5 | 7.1 | 15.9 | 19.1 |
| 3/8 | 1/4 | F6-FE-FNPT4- | 31.2 | 15.0 | 16.8 | 17.5 | 7.1 | 17.5 | 22.4 |
| 3/8 | 3/8 | F6-FE-FNPT6- | 33.3 | 15.0 | 16.8 | 17.5 | 7.1 | 20.6 | 22.4 |
| 3/8 | 1/2 | F6-FE-FNPT8- | 36.1 | 19.8 | 16.8 | 17.5 | 7.1 | 25.4 | 28.4 |
| 1/2 | 1/4 | F8-FE-FNPT4- | 36.1 | 15.0 | 22.9 | 22.2 | 10.4 | 20.6 | 22.4 |
| 1/2 | 3/8 | F8-FE-FNPT6- | 36.1 | 15.0 | 22.9 | 22.2 | 10.4 | 20.6 | 22.4 |
| 1/2 | 1/2 | F8-FE-FNPT8- | 38.9 | 19.8 | 22.9 | 22.2 | 10.4 | 25.4 | 28.4 |
| 5/8 | 3/8 | F10-FE-FNPT6- | 38.1 | 15.0 | 24.4 | 25.4 | 12.7 | 23.8 | 22.4 |
| 5/8 | 1/2 | F10-FE-FNPT8- | 39.9 | 19.8 | 24.4 | 25.4 | 12.7 | 27.0 | 28.4 |
| 3/4 | 1/2 | F12-FE-FNPT8- | 39.9 | 19.8 | 24.4 | 28.6 | 15.7 | 27.0 | 28.4 |
| 3/4 | 3/4 | F12-FE-FNPT12- | 44.7 | 20.6 | 24.4 | 28.6 | 15.7 | 34.9 | 31.8 |
| 7/8 | 3/4 | F14-FE-FNPT12- | 44.7 | 20.6 | 25.9 | 31.8 | 18.3 | 34.9 | 31.8 |
| 1 | 3/4 | F16-FE-FNPT12- | 49.0 | 20.6 | 31.2 | 38.1 | 22.4 | 34.9 | 31.8 |
| 1 | 1 | F16-FE-FNPT16- | 53.6 | 25.4 | 31.2 | 38.1 | 22.4 | 42.9 | 38.1 |

Метрическая трубка

Резьба NPT

| Трубка, мм | P-NPT Резьба | Артикул для заказа | Размеры, мм | | | | | | |
|------------|--------------|--------------------|-------------|------|------|----|------|------|------|
| | | | L | B | C | G | E | F | Lx |
| 6 | 1/8 | M6-FE-FNPT2- | 27.0 | 10.4 | 15.3 | 14 | 4.8 | 12.7 | 19.0 |
| 6 | 1/4 | M6-FE-FNPT4- | 29.8 | 15.0 | 15.3 | 14 | 4.8 | 17.5 | 22.4 |
| 8 | 1/8 | M8-FE-FNPT2- | 28.8 | 10.4 | 16.2 | 16 | 4.8 | 14.3 | 19.1 |
| 8 | 1/4 | M8-FE-FNPT4- | 30.6 | 15.0 | 16.2 | 16 | 6.4 | 17.5 | 22.4 |
| 10 | 1/4 | M10-FE-FNPT4- | 33.5 | 15.0 | 17.2 | 19 | 7.9 | 20.6 | 22.4 |
| 10 | 3/8 | M10-FE-FNPT6- | 33.5 | 15.0 | 17.2 | 19 | 7.9 | 20.6 | 22.4 |
| 10 | 1/2 | M10-FE-FNPT8- | 36.6 | 19.8 | 17.2 | 19 | 7.9 | 25.4 | 28.5 |
| 12 | 1/4 | M12-FE-FNPT4- | 36.0 | 15.0 | 22.8 | 22 | 7.9 | 20.6 | 22.4 |
| 12 | 3/8 | M12-FE-FNPT6- | 36.0 | 15.0 | 22.8 | 22 | 9.5 | 20.6 | 22.4 |
| 12 | 1/2 | M12-FE-FNPT8- | 38.8 | 19.8 | 22.8 | 22 | 9.5 | 25.4 | 28.4 |
| 16 | 3/8 | M16-FE-FNPT6- | 39.5 | 15.0 | 24.4 | 25 | 9.5 | 27.0 | 23.6 |
| 16 | 1/2 | M16-FE-FNPT8- | 39.5 | 19.8 | 24.4 | 25 | 12.7 | 27.0 | 28.5 |

Соединительный угольник

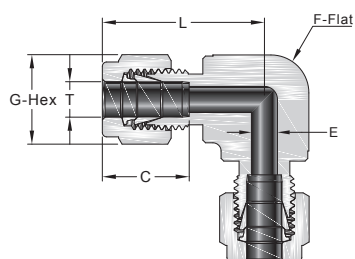

Дюймовая трубка

| Трубка, дюйм | Артикул для заказа | Размеры, мм | | | | |
|--------------|--------------------|-------------|------|------|------|------|
| | | L | C | G | F | E |
| 1/16 | F1-UE-F1- | 17.8 | 8.6 | 7.9 | 9.5 | 1.3 |
| 1/8 | F2-UE-F2- | 22.4 | 12.7 | 11.1 | 9.5 | 2.3 |
| 3/16 | F3-UE-F3- | 25.4 | 13.7 | 12.7 | 12.7 | 3.0 |
| 1/4 | F4-UE-F4- | 26.9 | 15.2 | 14.3 | 12.7 | 4.8 |
| 5/16 | F5-UE-F5- | 28.7 | 16.3 | 15.9 | 14.3 | 6.4 |
| 3/8 | F6-UE-F6- | 30.5 | 16.8 | 17.5 | 15.9 | 7.1 |
| 1/2 | F8-UE-F8- | 36.1 | 22.9 | 22.2 | 20.6 | 10.4 |
| 5/8 | F10-UE-F10- | 38.1 | 24.4 | 25.4 | 23.8 | 12.7 |
| 3/4 | F12-UE-F12- | 39.9 | 24.4 | 28.6 | 27.0 | 15.7 |
| 7/8 | F14-UE-F14- | 44.7 | 25.9 | 31.8 | 34.9 | 18.3 |
| 1 | F16-UE-F16- | 49.0 | 31.2 | 38.1 | 34.9 | 22.4 |
| 1 1/8 | F18-UE-F18- | 55.1 | 31.2 | 41.3 | 42.9 | 24.6 |
| 1 1/4 | F20-UE-F20- | 66.5 | 41.1 | 47.6 | 42.9 | 27.7 |
| 1 1/2 | F24-UE-F24- | 78.0 | 50.0 | 57.2 | 50.8 | 34.0 |

Метрическая трубка

| Трубка, мм | Артикул для заказа | Размеры, мм | | | | |
|------------|--------------------|-------------|------|----|------|------|
| | | L | C | G | F | E |
| 3 | M3-UE-M3- | 22.3 | 12.9 | 12 | 9.5 | 2.4 |
| 4 | M4-UE-M4- | 25.4 | 13.7 | 12 | 12.7 | 2.4 |
| 6 | M6-UE-M6- | 27.0 | 15.3 | 14 | 12.7 | 4.8 |
| 8 | M8-UE-M8- | 28.8 | 16.2 | 16 | 14.3 | 6.4 |
| 10 | M10-UE-M10- | 31.5 | 17.2 | 19 | 17.5 | 7.9 |
| 12 | M12-UE-M12- | 36.0 | 22.8 | 22 | 20.6 | 9.5 |
| 14 | M14-UE-M14- | 38.0 | 24.4 | 25 | 23.8 | 11.0 |
| 15 | M15-UE-M15- | 38.8 | 24.4 | 25 | 23.8 | 11.9 |
| 16 | M16-UE-M16- | 38.0 | 24.4 | 25 | 23.8 | 12.7 |
| 18 | M18-UE-M18- | 39.8 | 24.4 | 30 | 27.0 | 15.1 |
| 20 | M20-UE-M20- | 44.6 | 26.0 | 32 | 34.9 | 15.9 |
| 22 | M22-UE-M22- | 44.6 | 26.0 | 32 | 34.9 | 18.3 |
| 25 | M25-UE-M25- | 49.1 | 31.3 | 38 | 34.9 | 21.8 |
| 28 | M28-UE-M28- | 64.0 | 36.6 | 46 | 42.9 | 21.8 |
| 30 | M30-UE-M30- | 69.9 | 39.6 | 50 | 42.9 | 26.2 |
| 32 | M32-UE-M32- | 72.3 | 42.0 | 50 | 42.9 | 28.6 |
| 38 | M38-UE-M38- | 84.0 | 49.4 | 60 | 50.8 | 33.7 |

Переходной угольник

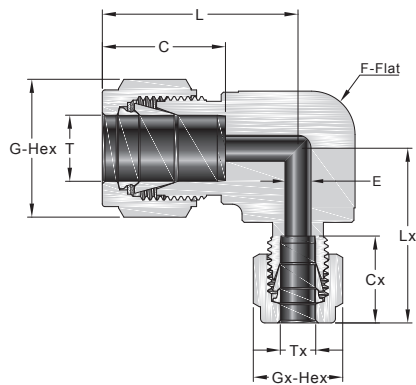

Дюймовая трубка

| Т-Трубка, дюйм | Тх-Трубка, дюйм | Артикул для заказа | Размеры, мм | | | | | | | | |
|----------------|-----------------|--------------------|-------------|------|------|------|------|------|------|------|--|
| | | | L | C | G | F | E | Cx | Gx | Lx | |
| 3/16 | 1/8 | F3-UE-F2- | 25.4 | 13.7 | 12.7 | 12.7 | 2.3 | 12.7 | 11.1 | 24.7 | |
| 1/4 | 1/8 | F4-UE-F2- | 26.9 | 15.2 | 14.3 | 12.7 | 2.3 | 12.7 | 11.1 | 25.4 | |
| 5/16 | 1/8 | F5-UE-F2- | 29.7 | 16.3 | 15.9 | 14.3 | 2.3 | 12.7 | 11.1 | 26.4 | |
| 5/16 | 1/4 | F5-UE-F4- | 29.7 | 16.3 | 15.9 | 14.3 | 4.8 | 15.2 | 14.3 | 29.0 | |
| 3/8 | 1/8 | F6-UE-F2- | 30.5 | 16.8 | 17.5 | 15.9 | 2.3 | 12.7 | 11.1 | 26.4 | |
| 3/8 | 1/4 | F6-UE-F4- | 30.5 | 16.8 | 17.5 | 15.9 | 4.8 | 15.2 | 14.3 | 29.0 | |
| 3/8 | 5/16 | F6-UE-F5- | 30.5 | 16.8 | 17.5 | 15.9 | 6.4 | 16.3 | 15.9 | 29.7 | |
| 1/2 | 1/4 | F8-UE-F4- | 36.1 | 22.9 | 22.2 | 20.6 | 4.8 | 15.2 | 14.3 | 32.2 | |
| 1/2 | 5/16 | F8-UE-F5- | 36.1 | 22.9 | 22.2 | 20.6 | 6.4 | 16.3 | 15.9 | 32.5 | |
| 1/2 | 3/8 | F8-UE-F6- | 36.1 | 22.9 | 22.2 | 20.6 | 7.1 | 16.8 | 17.5 | 33.6 | |
| 5/8 | 3/8 | F10-UE-F6- | 38.1 | 24.4 | 25.4 | 23.8 | 7.1 | 16.8 | 17.5 | 35.6 | |
| 5/8 | 1/2 | F10-UE-F8- | 38.1 | 24.4 | 25.4 | 23.8 | 10.4 | 22.9 | 22.2 | 38.1 | |
| 3/4 | 1/4 | F12-UE-F4- | 39.9 | 24.4 | 28.6 | 27.0 | 4.8 | 15.2 | 14.3 | 35.9 | |
| 3/4 | 3/8 | F12-UE-F6- | 39.9 | 24.4 | 28.6 | 27.0 | 7.1 | 16.8 | 17.5 | 37.4 | |
| 3/4 | 1/2 | F12-UE-F8- | 39.9 | 24.4 | 28.6 | 27.0 | 10.4 | 22.9 | 22.2 | 39.9 | |
| 7/8 | 1/4 | F14-UE-F4- | 44.7 | 25.9 | 31.8 | 34.9 | 4.8 | 15.2 | 14.3 | 40.7 | |
| 1 | 1/2 | F16-UE-F8- | 49.0 | 31.2 | 38.1 | 34.9 | 10.4 | 22.9 | 22.2 | 44.4 | |
| 1 | 3/4 | F16-UE-F12- | 49.0 | 31.2 | 38.1 | 34.9 | 15.7 | 24.4 | 28.6 | 44.4 | |

Метрическая трубка

| Т-Трубка, мм | Тх-Трубка, мм | Артикул для заказа | Размеры, мм | | | | | | | | |
|--------------|---------------|--------------------|-------------|------|----|------|-----|------|----|------|--|
| | | | L | C | G | F | E | Cx | Gx | Lx | |
| 8 | 6 | M8-UE-M6- | 28.8 | 16.2 | 16 | 14.3 | 4.8 | 15.3 | 14 | 27.9 | |
| 10 | 8 | M10-UE-M8- | 31.5 | 17.2 | 19 | 17.5 | 6.4 | 16.2 | 16 | 30.5 | |
| 12 | 8 | M12-UE-M8- | 36.0 | 22.8 | 22 | 20.6 | 6.4 | 16.2 | 16 | 32.6 | |
| 14 | 8 | M14-UE-M8- | 38.8 | 24.4 | 25 | 23.8 | 6.4 | 16.2 | 16 | 35.4 | |
| 14 | 10 | M14-UE-M10- | 38.8 | 24.4 | 25 | 23.8 | 7.9 | 17.2 | 19 | 36.4 | |

Тройник с внешней резьбой снизу

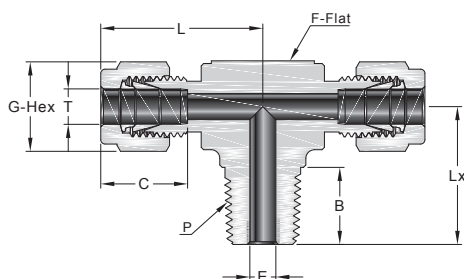

Дюймовая трубка

Резьба NPT

| Трубка, дюйм | P-NPT Резьба | Артикул для заказа | Размеры, мм | | | | | | |
|--------------|--------------|--------------------|-------------|------|------|------|------|------|------|
| | | | L | C | G | F | E | B | Lx |
| 1/8 | 1/8 | F2-MBT-F2-NPT2- | 23.6 | 12.7 | 11.1 | 11.1 | 2.3 | 9.7 | 17.8 |
| 1/8 | 1/4 | F2-MBT-F2-NPT4- | 24.6 | 12.7 | 11.1 | 12.7 | 2.3 | 14.2 | 23.4 |
| 3/16 | 1/8 | F3-MBT-F3-NPT2- | 24.4 | 13.7 | 12.7 | 11.1 | 3.0 | 9.7 | 17.8 |
| 1/4 | 1/8 | F4-MBT-F4-NPT2- | 26.9 | 15.2 | 14.3 | 12.7 | 4.8 | 9.7 | 18.8 |
| 1/4 | 1/4 | F4-MBT-F4-NPT4- | 26.9 | 15.2 | 14.3 | 12.7 | 4.8 | 14.2 | 23.4 |
| 5/16 | 1/8 | F5-MBT-F5-NPT2- | 29.7 | 16.3 | 15.9 | 15.9 | 4.8 | 9.7 | 20.8 |
| 5/16 | 1/4 | F5-MBT-F5-NPT4- | 29.7 | 16.3 | 15.9 | 15.9 | 6.4 | 14.2 | 25.7 |
| 3/8 | 1/4 | F6-MBT-F6-NPT4- | 30.5 | 16.8 | 17.5 | 15.9 | 7.1 | 14.2 | 25.4 |
| 3/8 | 3/8 | F6-MBT-F6-NPT6- | 33.3 | 16.8 | 17.5 | 20.6 | 7.1 | 14.2 | 28.2 |
| 1/2 | 3/8 | F8-MBT-F8-NPT6- | 36.1 | 22.9 | 22.2 | 20.6 | 9.7 | 14.2 | 28.2 |
| 1/2 | 1/2 | F8-MBT-F8-NPT8- | 36.1 | 22.9 | 22.2 | 20.6 | 10.4 | 19.1 | 33.0 |
| 5/8 | 1/2 | F10-MBT-F10-NPT8- | 38.9 | 24.4 | 25.4 | 25.4 | 11.9 | 19.1 | 35.8 |
| 3/4 | 3/4 | F12-MBT-F12-NPT12- | 39.9 | 24.4 | 28.6 | 27.0 | 15.7 | 19.1 | 36.8 |
| 7/8 | 3/4 | F14-MBT-F14-NPT12- | 44.7 | 25.9 | 31.8 | 33.3 | 15.7 | 19.1 | 38.1 |
| 1 | 3/4 | F16-MBT-F16-NPT12- | 49.3 | 31.2 | 38.1 | 33.3 | 15.7 | 19.1 | 42.2 |
| 1 | 1 | F16-MBT-F16-NPT16- | 49.3 | 31.2 | 38.1 | 34.9 | 22.4 | 23.9 | 46.7 |

Метрическая трубка

Резьба NPT

| Трубка, мм | P-NPT Резьба | Артикул для заказа | Размеры, мм | | | | | | |
|------------|--------------|--------------------|-------------|------|----|------|------|------|------|
| | | | L | C | G | F | E | B | Lx |
| 6 | 1/8 | M6-MBT-M6-NPT2- | 27.0 | 15.3 | 14 | 12.7 | 4.8 | 9.7 | 18.8 |
| 6 | 1/4 | M6-MBT-M6-NPT4- | 27.0 | 15.3 | 14 | 12.7 | 4.8 | 14.2 | 23.4 |
| 8 | 1/8 | M8-MBT-M8-NPT2- | 29.9 | 16.2 | 16 | 15.9 | 4.8 | 9.7 | 20.8 |
| 8 | 1/4 | M8-MBT-M8-NPT4- | 29.9 | 16.2 | 16 | 15.9 | 6.4 | 14.2 | 25.4 |
| 10 | 1/4 | M10-MBT-M10-NPT4- | 33.5 | 17.2 | 19 | 20.6 | 7.9 | 14.2 | 28.2 |
| 10 | 3/8 | M10-MBT-M10-NPT6- | 33.5 | 17.2 | 19 | 20.6 | 7.9 | 14.2 | 28.2 |
| 12 | 1/4 | M12-MBT-M12-NPT4- | 36.0 | 22.8 | 22 | 20.6 | 7.9 | 14.2 | 28.2 |
| 12 | 3/8 | M12-MBT-M12-NPT6- | 36.0 | 22.8 | 22 | 20.6 | 9.5 | 14.2 | 28.2 |
| 12 | 1/2 | M12-MBT-M12-NPT8- | 36.0 | 22.8 | 22 | 20.6 | 9.5 | 19.1 | 33.0 |
| 16 | 1/2 | M16-MBT-M16-NPT8- | 38.8 | 24.4 | 25 | 25.4 | 11.9 | 19.1 | 35.8 |

Тройник с внешней резьбой сбоку

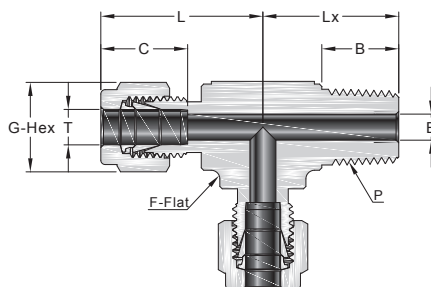

Дюймовая трубка

Резьба NPT

| Трубка, дюйм | P-NPT Резьба | Артикул для заказа | Размеры, мм | | | | | | |
|--------------|--------------|--------------------|-------------|------|------|------|------|------|------|
| | | | L | C | G | F | E | B | Lx |
| 1/8 | 1/8 | F2-MRT-NPT2-F2- | 23.6 | 12.7 | 11.1 | 11.1 | 2.3 | 9.7 | 17.8 |
| 1/8 | 1/4 | F2-MRT-NPT4-F2- | 24.6 | 12.7 | 11.1 | 12.7 | 2.3 | 14.2 | 23.4 |
| 3/16 | 1/8 | F3-MRT-NPT2-F3- | 24.4 | 13.7 | 12.7 | 11.1 | 3.0 | 9.7 | 17.8 |
| 1/4 | 1/8 | F4-MRT-NPT2-F4- | 26.9 | 15.2 | 14.3 | 12.7 | 4.8 | 9.7 | 18.8 |
| 1/4 | 1/4 | F4-MRT-NPT4-F4- | 26.9 | 15.2 | 14.3 | 12.7 | 4.8 | 14.2 | 23.4 |
| 5/16 | 1/8 | F5-MRT-NPT2-F5- | 29.7 | 16.3 | 15.9 | 15.9 | 4.8 | 9.7 | 20.8 |
| 5/16 | 1/4 | F5-MRT-NPT4-F5- | 29.7 | 16.3 | 15.9 | 15.9 | 6.4 | 14.2 | 25.7 |
| 3/8 | 1/4 | F6-MRT-NPT4-F6- | 30.5 | 16.8 | 17.5 | 15.9 | 7.1 | 14.2 | 25.4 |
| 3/8 | 3/8 | F6-MRT-NPT6-F6- | 33.3 | 16.8 | 17.5 | 20.6 | 7.1 | 14.2 | 28.2 |
| 1/2 | 3/8 | F8-MRT-NPT6-F8- | 36.1 | 22.9 | 22.2 | 20.6 | 9.7 | 14.2 | 28.2 |
| 1/2 | 1/2 | F8-MRT-NPT8-F8- | 36.1 | 22.9 | 22.2 | 20.6 | 10.4 | 19.1 | 33.0 |
| 5/8 | 1/2 | F10-MRT-NPT8-F10- | 38.1 | 24.4 | 25.4 | 23.8 | 11.9 | 19.1 | 35.8 |
| 3/4 | 3/4 | F12-MRT-NPT12-F12- | 39.9 | 24.4 | 28.6 | 27.0 | 15.7 | 19.1 | 36.8 |
| 7/8 | 3/4 | F14-MRT-NPT12-F14- | 44.7 | 25.9 | 31.8 | 33.3 | 15.7 | 19.1 | 38.1 |
| 1 | 3/4 | F16-MRT-NPT12-F16- | 49.3 | 31.2 | 38.1 | 33.3 | 15.7 | 19.1 | 42.2 |
| 1 | 1 | F16-MRT-NPT16-F16- | 49.3 | 31.2 | 38.1 | 34.9 | 22.4 | 23.9 | 46.7 |

Метрическая трубка

Резьба NPT

| Трубка, мм | P-NPT Резьба | Артикул для заказа | Размеры, мм | | | | | | |
|------------|--------------|--------------------|-------------|------|----|------|------|------|------|
| | | | L | C | G | F | E | B | Lx |
| 6 | 1/8 | M6-MRT-NPT2-M6- | 27.0 | 15.3 | 14 | 12.7 | 4.8 | 9.7 | 18.0 |
| 6 | 1/4 | M6-MRT-NPT4-M6- | 27.0 | 15.3 | 14 | 12.7 | 4.8 | 14.2 | 23.4 |
| 8 | 1/8 | M8-MRT-NPT2-M8- | 29.9 | 16.2 | 16 | 15.9 | 4.8 | 9.7 | 20.8 |
| 8 | 1/4 | M8-MRT-NPT4-M8- | 29.9 | 16.2 | 16 | 15.9 | 6.4 | 14.2 | 25.4 |
| 10 | 1/4 | M10-MRT-NPT4-M10- | 33.5 | 17.2 | 19 | 20.6 | 7.9 | 14.2 | 28.2 |
| 10 | 1/2 | M10-MRT-NPT8-M10- | 33.5 | 17.2 | 19 | 20.6 | 7.9 | 14.2 | 28.2 |
| 12 | 1/4 | M12-MRT-NPT4-M12- | 36.0 | 22.8 | 22 | 20.6 | 7.9 | 14.2 | 28.2 |
| 12 | 3/8 | M12-MRT-NPT6-M12- | 36.0 | 22.8 | 22 | 20.6 | 9.5 | 14.2 | 28.2 |
| 12 | 1/2 | M12-MRT-NPT8-M12- | 36.0 | 22.8 | 22 | 20.6 | 9.5 | 19.1 | 33.0 |
| 16 | 1/2 | M16-MRT-NPT8-M16- | 38.0 | 24.4 | 25 | 23.8 | 11.9 | 19.1 | 35.0 |

Позиционируемый тройник с внешней резьбой снизу

Прямая резьба SAE/MS

Адаптер по стандартам SAE J1926-1, ISO 11926-1 и MS 16142.

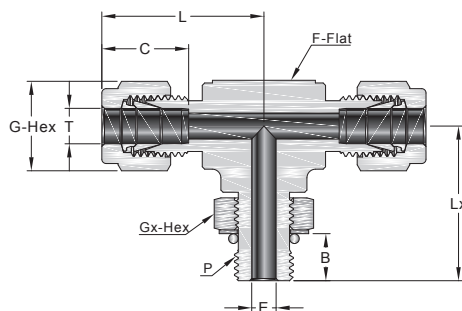

Дюймовая трубка

Прямая резьба SAE/MS

| Трубка, дюйм | P-SAE/MS Резьба | Артикул для заказа | Размеры, мм | | | | | | | |
|--------------|-----------------|---------------------|-------------|------|------|------|------|------|------|------|
| | | | L | B | C | E | G | F | Lx | Gx |
| 1/4 | 7/16-20 | F4-PMBT-F4-PST7- | 28.5 | 9.9 | 15.2 | 4.8 | 14.3 | 12.7 | 28.5 | 14.3 |
| 3/8 | 9/16-18 | F6-PMBT-F6-PST9- | 32.0 | 11.2 | 16.8 | 7.1 | 17.5 | 15.9 | 32.3 | 17.5 |
| 1/2 | 3/4-16 | F8-PMBT-F8-PST12- | 37.6 | 12.7 | 22.9 | 10.4 | 22.2 | 20.6 | 37.8 | 22.2 |
| 3/4 | 1 1/16-12 | F12-PMBT-F12-PST17- | 41.4 | 16.8 | 24.4 | 15.7 | 28.6 | 27.0 | 48.8 | 28.6 |
| 1 | 1 5/16-12 | F16-PMBT-F16-PST21- | 50.5 | 16.8 | 31.2 | 22.4 | 38.1 | 34.9 | 53.6 | 38.1 |
| 1 1/4 | 1 5/8-12 | F20-PMBT-F20-PST26- | 67.8 | 16.8 | 41.1 | 27.7 | 47.6 | 42.9 | 58.2 | 47.6 |
| 1 1/4 | 1 7/8-12 | F24-PMBT-F24-PST30- | 78.0 | 16.8 | 50.0 | 34.0 | 57.2 | 50.8 | 60.5 | 54.0 |

Позиционируемый тройник с внешней резьбой снизу

Цилиндрическая резьба ISO

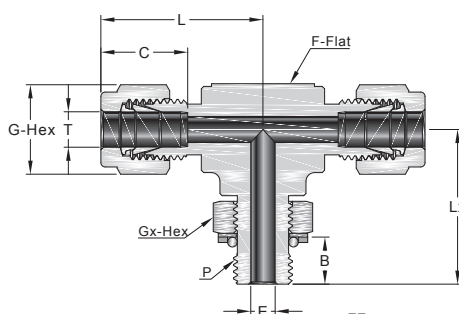

Дюймовая трубка

Цилиндрическая резьба ISO (PPT)

| Трубка, дюйм | P-ISO Цилиндрическая резьба | Артикул для заказа | Размеры, мм | | | | | | | |
|--------------|-----------------------------|---------------------|-------------|------|------|------|------|------|------|------|
| | | | L | B | C | E | G | F | Lx | Gx |
| 1/4 | 1/8 | F4-PMBT-F4-PPT2- | 26.9 | 8.1 | 15.2 | 4.1 | 14.3 | 12.7 | 26.4 | 14.3 |
| 1/4 | 1/4 | F4-PMBT-F4-PPT4- | 29.0 | 9.1 | 15.2 | 4.8 | 14.3 | 15.9 | 32.3 | 19.1 |
| 3/8 | 1/4 | F6-PMBT-F6-PPT4- | 30.5 | 9.1 | 16.8 | 5.8 | 17.5 | 15.9 | 32.3 | 19.1 |
| 1/2 | 3/8 | F8-PMBT-F8-PPT6- | 36.1 | 9.4 | 22.9 | 7.9 | 22.2 | 20.6 | 37.1 | 22.2 |
| 1/2 | 1/2 | F8-PMBT-F8-PPT8- | 38.1 | 13.0 | 22.9 | 10.4 | 22.2 | 23.8 | 43.4 | 27.0 |
| 5/8 | 1/2 | F10-PMBT-F10-PPT8- | 38.1 | 13.0 | 24.4 | 11.9 | 25.4 | 23.8 | 43.4 | 27.0 |
| 3/4 | 1/2 | F12-PMBT-F12-PPT8- | 39.9 | 13.0 | 24.4 | 11.9 | 28.6 | 27.0 | 45.2 | 27.0 |
| 3/4 | 3/4 | F12-PMBT-F12-PPT12- | 39.9 | 13.0 | 24.4 | 15.7 | 28.6 | 27.0 | 48.8 | 34.9 |
| 1 | 1 | F16-PMBT-F16-PPT16- | 49.0 | 14.0 | 31.2 | 19.8 | 38.1 | 34.9 | 53.6 | 41.3 |

Метрическая трубка

Цилиндрическая резьба ISO (PPT)

| Трубка, мм | P-ISO Цилиндрическая резьба | Артикул для заказа | Размеры, мм | | | | | | | |
|------------|-----------------------------|--------------------|-------------|------|------|-----|----|------|------|------|
| | | | L | B | C | E | G | F | Lx | Gx |
| 6 | 1/8 | M6-PMBT-M6-PPT2- | 27.0 | 8.1 | 15.3 | 4.0 | 14 | 12.7 | 26.4 | 14.3 |
| 6 | 1/4 | M6-PMBT-M6-PPT4- | 29.0 | 9.1 | 15.3 | 4.8 | 14 | 15.9 | 32.2 | 19.1 |
| 8 | 1/8 | M8-PMBT-M8-PPT2- | 28.8 | 8.1 | 16.2 | 4.0 | 16 | 14.3 | 27.5 | 14.3 |
| 8 | 1/4 | M8-PMBT-M8-PPT4- | 29.9 | 9.1 | 16.2 | 5.9 | 16 | 15.9 | 32.2 | 19.1 |
| 10 | 1/4 | M10-PMBT-M10-PPT4- | 33.5 | 9.1 | 17.2 | 5.9 | 19 | 20.6 | 35.1 | 19.1 |
| 12 | 3/8 | M12-PMBT-M12-PPT6- | 36.0 | 9.4 | 22.8 | 7.9 | 22 | 20.6 | 37.1 | 22.2 |
| 12 | 1/2 | M12-PMBT-M12-PPT8- | 38.0 | 13.0 | 22.8 | 9.5 | 22 | 23.8 | 43.5 | 27.0 |

Позиционируемый тройник с внешней резьбой сбоку

Прямая резьба SAE/MS

Адаптер по стандартам SAE J1926-1, ISO 11926-1 и MS 16142.

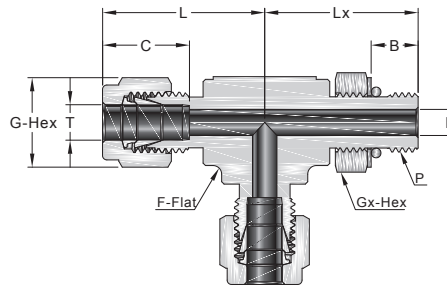

Дюймовая трубка

Прямая резьба SAE/MS

| Трубка, дюйм | P-SAE/MS Резьба | Артикул для заказа | Размеры, мм | | | | | | | |
|--------------|-----------------|---------------------|-------------|------|------|------|------|------|------|------|
| | | | L | B | C | E | G | F | Lx | Gx |
| 1/4 | 7/16-20 | F4-PMRT-PST7-F4- | 28.5 | 9.9 | 15.2 | 4.8 | 14.3 | 12.7 | 28.5 | 14.3 |
| 3/8 | 9/16-18 | F6-PMRT-PST9-F6- | 32.0 | 11.2 | 16.8 | 7.1 | 17.5 | 15.9 | 32.3 | 17.5 |
| 1/2 | 3/4-16 | F8-PMRT-PST12-F8- | 37.6 | 12.7 | 22.9 | 10.4 | 22.2 | 20.6 | 37.8 | 22.2 |
| 3/4 | 1 1/16-12 | F12-PMRT-PST17-F12- | 41.4 | 16.8 | 24.4 | 15.7 | 28.6 | 27.0 | 48.8 | 28.6 |
| 1 | 1 5/16-12 | F16-PMRT-PST21-F16- | 50.5 | 16.8 | 31.2 | 22.4 | 38.1 | 34.9 | 53.6 | 38.1 |
| 1 1/4 | 1 5/8-12 | F20-PMRT-PST26-F20- | 67.8 | 16.8 | 41.1 | 27.7 | 47.6 | 42.9 | 58.2 | 47.6 |
| 1 1/2 | 1 7/8-12 | F24-PMRT-PST30-F24- | 78.0 | 16.8 | 50.0 | 34.0 | 57.2 | 50.8 | 60.5 | 54.0 |

Позиционируемый тройник с внешней резьбой сбоку

Цилиндрическая резьба ISO

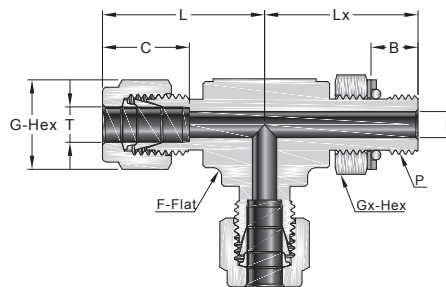

Дюймовая трубка

Цилиндрическая резьба ISO (PPT)

| Трубка, дюйм | P-ISO Цилиндрическая резьба | Артикул для заказа | Размеры, мм | | | | | | | |
|--------------|-----------------------------|---------------------|-------------|------|------|------|------|------|------|------|
| | | | L | B | C | E | G | F | Lx | Gx |
| 1/4 | 1/8 | F4-PMRT-PPT2-F4- | 26.9 | 8.1 | 15.2 | 4.1 | 14.3 | 12.7 | 26.4 | 14.3 |
| 1/4 | 1/4 | F4-PMRT-PPT4-F4- | 29.0 | 9.1 | 15.2 | 4.8 | 14.3 | 15.9 | 32.3 | 19.1 |
| 3/8 | 1/4 | F6-PMRT-PPT4-F6- | 30.5 | 9.1 | 16.8 | 5.8 | 17.5 | 15.9 | 32.3 | 19.1 |
| 1/2 | 3/8 | F8-PMRT-PPT6-F8- | 36.1 | 9.4 | 22.9 | 7.9 | 22.2 | 20.6 | 37.1 | 22.2 |
| 1/2 | 1/2 | F8-PMRT-PPT8-F8- | 38.1 | 13.0 | 22.9 | 10.4 | 22.2 | 23.8 | 43.4 | 27.0 |
| 5/8 | 1/2 | F10-PMRT-PPT8-F10- | 38.1 | 13.0 | 24.4 | 11.9 | 25.4 | 23.8 | 43.4 | 27.0 |
| 3/4 | 1/2 | F12-PMRT-PPT8-F12- | 39.9 | 13.0 | 24.4 | 11.9 | 28.6 | 27.0 | 45.2 | 27.0 |
| 3/4 | 3/4 | F12-PMRT-PPT12-F12- | 39.9 | 13.0 | 24.4 | 15.7 | 28.6 | 27.0 | 48.8 | 34.9 |
| 1 | 1 | F16-PMRT-PPT16-F16- | 49.0 | 14.0 | 31.2 | 19.8 | 38.1 | 34.9 | 53.6 | 41.3 |

Метрическая трубка

Цилиндрическая резьба ISO (PPT)

| Трубка, мм | P-ISO Цилиндрическая резьба | Артикул для заказа | Размеры, мм | | | | | | | |
|------------|-----------------------------|--------------------|-------------|------|------|-----|----|------|------|------|
| | | | L | B | C | E | G | F | Lx | Gx |
| 6 | 1/8 | M6-PMRT-PPT2-M6- | 27.0 | 8.1 | 15.3 | 4.0 | 14 | 12.7 | 26.4 | 14.3 |
| 6 | 1/4 | M6-PMRT-PPT4-M6- | 29.0 | 9.1 | 15.3 | 4.8 | 14 | 15.9 | 32.2 | 19.1 |
| 8 | 1/8 | M8-PMRT-PPT2-M8- | 28.8 | 8.1 | 16.2 | 4.0 | 16 | 14.3 | 27.5 | 14.3 |
| 8 | 1/4 | M8-PMRT-PPT4-M8- | 29.9 | 9.1 | 16.2 | 5.9 | 16 | 15.9 | 32.2 | 19.1 |
| 10 | 1/4 | M10-PMRT-PPT4-M10- | 33.5 | 9.1 | 17.2 | 5.9 | 19 | 20.6 | 35.1 | 19.1 |
| 12 | 3/8 | M12-PMRT-PPT6-M12- | 36.0 | 9.4 | 22.8 | 7.9 | 22 | 20.6 | 37.1 | 22.2 |
| 12 | 1/2 | M12-PMRT-PPT8-M12- | 38.0 | 13.0 | 22.8 | 9.5 | 22 | 23.8 | 43.5 | 27.0 |

Тройник с внутренней резьбой снизу

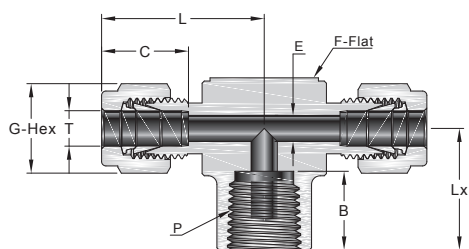

Дюймовая трубка

Резьба NPT

| Трубка, дюйм | P-NPT Резьба | Артикул для заказа | Размеры, мм | | | | | | |
|--------------|--------------|---------------------|-------------|------|------|------|------|------|------|
| | | | L | C | G | F | E | B | Lx |
| 1/8 | 1/8 | F2-FBT-F2-FNPT2- | 24.6 | 12.7 | 11.1 | 12.7 | 2.3 | 10.4 | 19.1 |
| 3/16 | 1/8 | F3-FBT-F3-FNPT2- | 25.7 | 13.7 | 12.7 | 12.7 | 3.0 | 10.4 | 19.1 |
| 1/4 | 1/8 | F4-FBT-F4-FNPT2- | 26.9 | 15.2 | 14.3 | 12.7 | 4.8 | 10.4 | 19.1 |
| 1/4 | 1/4 | F4-FBT-F4-FNPT4- | 29.7 | 15.2 | 14.3 | 17.5 | 4.8 | 15.0 | 22.4 |
| 5/16 | 1/8 | F5-FBT-F5-FNPT2- | 29.7 | 16.2 | 15.9 | 15.9 | 6.4 | 10.4 | 19.1 |
| 3/8 | 1/4 | F6-FBT-F6-FNPT4- | 31.2 | 16.8 | 17.5 | 17.5 | 7.1 | 15.0 | 22.4 |
| 3/8 | 3/8 | F6-FBT-F6-FNPT6- | 33.3 | 16.8 | 17.5 | 20.6 | 7.1 | 15.0 | 22.4 |
| 3/8 | 1/2 | F6-FBT-F6-FNPT8- | 36.1 | 16.8 | 17.5 | 25.4 | 7.1 | 19.8 | 28.4 |
| 1/2 | 1/4 | F8-FBT-F8-FNPT4- | 36.1 | 22.9 | 22.2 | 20.6 | 10.4 | 15.0 | 22.4 |
| 1/2 | 3/8 | F8-FBT-F8-FNPT6- | 36.1 | 22.9 | 22.2 | 20.6 | 10.4 | 15.0 | 22.4 |
| 1/2 | 1/2 | F8-FBT-F8-FNPT8- | 38.9 | 22.9 | 22.2 | 25.4 | 10.4 | 19.8 | 28.4 |
| 5/8 | 1/2 | F10-FBT-F10-FNPT8- | 38.9 | 24.4 | 25.4 | 25.4 | 12.7 | 19.8 | 28.4 |
| 3/4 | 3/4 | F12-FBT-F12-FNPT12- | 44.7 | 24.4 | 28.6 | 34.9 | 15.7 | 20.6 | 31.8 |
| 7/8 | 3/4 | F14-FBT-F14-FNPT12- | 44.7 | 25.9 | 31.8 | 34.9 | 18.3 | 20.6 | 31.8 |
| 1 | 3/4 | F16-FBT-F16-FNPT12- | 49.0 | 31.2 | 38.1 | 34.9 | 22.4 | 20.6 | 31.8 |
| 1 | 1 | F16-FBT-F16-FNPT16- | 53.6 | 31.2 | 38.1 | 42.9 | 22.4 | 25.4 | 38.1 |

Метрическая трубка

Резьба NPT

| Трубка, мм | P-NPT Резьба | Артикул для заказа | Размеры, мм | | | | | | |
|------------|--------------|--------------------|-------------|------|----|------|------|------|------|
| | | | L | C | G | F | E | B | Lx |
| 6 | 1/8 | M6-FBT-M6-FNPT2- | 27.0 | 15.3 | 14 | 12.7 | 4.8 | 10.4 | 19.0 |
| 6 | 1/4 | M6-FBT-M6-FNPT4- | 29.8 | 15.3 | 14 | 17.5 | 4.8 | 15.0 | 22.4 |
| 8 | 1/8 | M8-FBT-M8-FNPT2- | 29.9 | 16.2 | 16 | 15.9 | 6.4 | 10.4 | 19.0 |
| 8 | 1/4 | M8-FBT-M8-FNPT4- | 30.6 | 16.2 | 16 | 17.5 | 6.4 | 15.0 | 22.4 |
| 10 | 1/4 | M10-FBT-M10-FNPT4- | 33.5 | 17.2 | 19 | 20.6 | 7.9 | 15.0 | 22.4 |
| 12 | 1/8 | M12-FBT-M12-FNPT2- | 36.0 | 22.8 | 22 | 20.6 | 6.4 | 10.4 | 22.3 |
| 12 | 1/4 | M12-FBT-M12-FNPT4- | 36.0 | 22.8 | 22 | 20.6 | 9.5 | 15.0 | 22.4 |
| 12 | 3/8 | M12-FBT-M12-FNPT6- | 36.0 | 22.8 | 22 | 20.6 | 9.5 | 15.0 | 22.4 |
| 12 | 1/2 | M12-FBT-M12-FNPT8- | 38.8 | 22.8 | 22 | 25.4 | 9.5 | 19.8 | 28.5 |
| 16 | 1/2 | M16-FBT-M16-FNPT8- | 38.8 | 24.4 | 25 | 25.4 | 12.7 | 19.8 | 28.4 |

Тройник с внутренней резьбой снизу

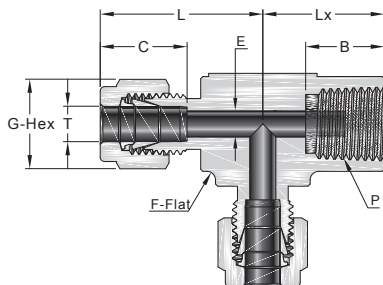

Дюймовая трубка

Резьба NPT

| Трубка, дюйм | P-NPT Резьба | Артикул для заказа | Размеры, мм | | | | | | |
|--------------|--------------|---------------------|-------------|------|------|------|------|------|------|
| | | | L | C | G | F | E | B | Lx |
| 1/8 | 1/8 | F2-FRT-FNPT2-F2- | 24.6 | 12.7 | 11.1 | 12.7 | 2.3 | 10.4 | 19.1 |
| 3/16 | 1/8 | F3-FRT-FNPT2-F3- | 25.7 | 13.7 | 12.7 | 12.7 | 3.0 | 10.4 | 19.1 |
| 1/4 | 1/8 | F4-FRT-FNPT2-F4- | 26.9 | 15.2 | 14.3 | 12.7 | 4.8 | 10.4 | 19.1 |
| 1/4 | 1/4 | F4-FRT-FNPT4-F4- | 29.7 | 15.2 | 14.3 | 17.5 | 4.8 | 15.0 | 22.4 |
| 5/16 | 1/8 | F5-FRT-FNPT2-F5- | 29.7 | 16.2 | 15.9 | 15.9 | 6.4 | 10.4 | 19.1 |
| 3/8 | 1/4 | F6-FRT-FNPT4-F6- | 31.2 | 16.8 | 17.5 | 17.5 | 7.1 | 15.0 | 22.4 |
| 1/2 | 1/4 | F8-FRT-FNPT4-F8- | 36.1 | 22.9 | 22.2 | 20.6 | 10.4 | 15.0 | 22.4 |
| 1/2 | 3/8 | F8-FRT-FNPT6-F8- | 36.1 | 22.9 | 22.2 | 20.6 | 10.4 | 15.0 | 22.4 |
| 1/2 | 1/2 | F8-FRT-FNPT8-F8- | 39.9 | 22.9 | 22.2 | 27.0 | 10.4 | 19.8 | 28.4 |
| 5/8 | 1/2 | F10-FRT-FNPT8-F10- | 39.9 | 24.4 | 25.4 | 27.0 | 12.7 | 19.8 | 28.4 |
| 3/4 | 3/4 | F12-FRT-FNPT12-F12- | 44.7 | 24.4 | 28.6 | 34.9 | 15.7 | 20.6 | 31.8 |
| 7/8 | 1/2 | F14-FRT-FNPT8-F14- | 44.7 | 25.9 | 31.8 | 34.9 | 15.7 | 19.8 | 28.4 |
| 7/8 | 3/4 | F14-FRT-FNPT12-F14- | 44.7 | 25.9 | 31.8 | 34.9 | 18.3 | 20.6 | 31.8 |
| 1 | 3/4 | F16-FRT-FNPT12-F16- | 49.0 | 31.2 | 38.1 | 34.9 | 22.4 | 20.6 | 31.8 |
| 1 | 1 | F16-FRT-FNPT16-F16- | 53.6 | 31.2 | 38.1 | 42.9 | 22.4 | 25.4 | 38.1 |

Метрическая трубка

Резьба NPT

| Трубка, мм | P-NPT Резьба | Артикул для заказа | Размеры, мм | | | | | | |
|------------|--------------|--------------------|-------------|------|----|------|------|------|------|
| | | | L | C | G | F | E | B | Lx |
| 6 | 1/8 | M6-FRT-FNPT2-M6- | 27.0 | 15.3 | 14 | 12.7 | 4.8 | 10.4 | 19.0 |
| 6 | 1/4 | M6-FRT-FNPT4-M6- | 29.8 | 15.3 | 14 | 17.5 | 4.8 | 15.0 | 22.4 |
| 8 | 1/8 | M8-FRT-FNPT2-M8- | 29.9 | 16.2 | 16 | 15.9 | 4.8 | 10.4 | 19.0 |
| 8 | 1/4 | M8-FRT-FNPT4-M8- | 30.6 | 16.2 | 16 | 17.5 | 6.4 | 15.0 | 22.4 |
| 10 | 1/4 | M10-FRT-FNPT4-M10- | 33.5 | 17.2 | 19 | 20.6 | 7.9 | 15.0 | 22.4 |
| 12 | 1/4 | M12-FRT-FNPT4-M12- | 36.0 | 22.8 | 22 | 20.6 | 9.5 | 15.0 | 22.4 |
| 12 | 3/8 | M12-FRT-FNPT6-M12- | 36.0 | 22.8 | 22 | 20.6 | 9.5 | 15.0 | 23.1 |
| 12 | 1/2 | M12-FRT-FNPT8-M12- | 38.8 | 22.8 | 22 | 25.4 | 9.5 | 19.8 | 28.5 |
| 16 | 1/2 | M16-FRT-FNPT8-M16- | 39.8 | 24.4 | 25 | 27.0 | 11.9 | 19.8 | 28.4 |

Соединительный тройник

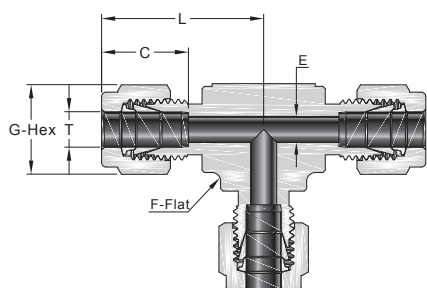

Дюймовая трубка

| Трубка, дюйм | Артикул для заказа | Размеры, мм | | | | |
|--------------|--------------------|-------------|------|------|------|------|
| | | L | C | G | F | E |
| 1/16 | F1-UT-F1-F1- | 17.8 | 8.6 | 7.9 | 9.5 | 1.3 |
| 1/8 | F2-UT-F2-F2- | 22.4 | 12.7 | 11.1 | 9.5 | 2.3 |
| 3/16 | F3-UT-F3-F3- | 24.4 | 13.7 | 12.7 | 11.1 | 3.0 |
| 1/4 | F4-UT-F4-F4- | 26.9 | 15.2 | 14.3 | 12.7 | 4.8 |
| 5/16 | F5-UT-F5-F5- | 29.7 | 16.2 | 15.9 | 15.9 | 6.4 |
| 3/8 | F6-UT-F6-F6- | 30.5 | 16.8 | 17.5 | 15.9 | 7.1 |
| 1/2 | F8-UT-F8-F8- | 36.1 | 22.9 | 22.2 | 20.6 | 10.4 |
| 5/8 | F10-UT-F10-F10- | 38.9 | 24.4 | 25.4 | 25.4 | 12.7 |
| 3/4 | F12-UT-F12-F12- | 39.9 | 24.4 | 28.6 | 27.0 | 15.7 |
| 7/8 | F14-UT-F14-F14- | 44.7 | 25.9 | 31.8 | 34.9 | 18.3 |
| 1 | F16-UT-F16-F16- | 49.0 | 31.2 | 38.1 | 34.9 | 22.4 |
| 1 1/8 | F18-UT-F18-F18- | 55.1 | 31.2 | 46.0 | 42.9 | 24.6 |
| 1 1/4 | F20-UT-F20-F20- | 66.5 | 41.1 | 47.6 | 42.9 | 27.7 |
| 1 1/2 | F24-UT-F24-F24- | 78.0 | 50.0 | 57.2 | 50.8 | 34.0 |

Метрическая трубка

| Трубка, мм | Артикул для заказа | Размеры, мм | | | | |
|------------|--------------------|-------------|------|----|------|------|
| | | L | C | G | F | E |
| 2 | M2-UT-M2-M2- | 22.3 | 12.9 | 12 | 9.5 | 1.7 |
| 3 | M3-UT-M3-M3- | 22.3 | 12.9 | 12 | 9.5 | 2.4 |
| 4 | M4-UT-M4-M4- | 25.4 | 13.7 | 12 | 12.7 | 2.4 |
| 6 | M6-UT-M6-M6- | 27.0 | 15.3 | 14 | 12.7 | 4.8 |
| 8 | M8-UT-M8-M8- | 29.9 | 16.2 | 16 | 15.9 | 6.4 |
| 10 | M10-UT-M10-M10- | 31.5 | 17.2 | 19 | 17.5 | 7.9 |
| 12 | M12-UT-M12-M12- | 36.0 | 22.8 | 22 | 20.6 | 9.5 |
| 14 | M14-UT-M14-M14- | 38.8 | 24.4 | 25 | 25.4 | 11.1 |
| 15 | M15-UT-M15-M15- | 38.8 | 24.4 | 25 | 25.4 | 11.9 |
| 16 | M16-UT-M16-M16- | 38.8 | 24.4 | 25 | 25.4 | 12.7 |
| 18 | M18-UT-M18-M18- | 38.8 | 24.4 | 30 | 27.0 | 15.1 |
| 20 | M20-UT-M20-M20- | 44.6 | 26.0 | 32 | 34.9 | 15.9 |
| 22 | M22-UT-M22-M22- | 44.6 | 26.0 | 32 | 34.9 | 18.3 |
| 25 | M25-UT-M25-M25- | 49.1 | 31.3 | 38 | 34.9 | 21.8 |
| 28 | M28-UT-M28-M28- | 64.0 | 36.6 | 46 | 42.9 | 21.8 |
| 30 | M30-UT-M30-M30- | 69.9 | 39.6 | 50 | 42.9 | 26.2 |
| 32 | M32-UT-M32-M32- | 72.3 | 42.0 | 50 | 42.9 | 28.6 |
| 38 | M38-UT-M38-M38- | 84.0 | 49.4 | 60 | 50.8 | 33.7 |

Переходной соединительный тройник

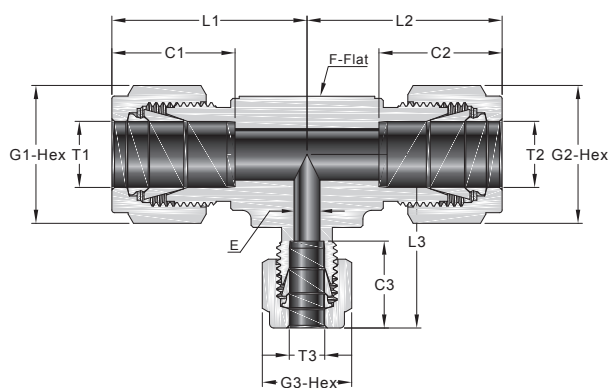

Двойная грубка

| Т1- грубка, дюйм | Т2- грубка, дюйм | Т3- грубка, дюйм | Артикул для заказа | Размеры, мм | | | | | | | | | | |
|------------------------|------------------------|------------------------|-----------------------|-------------|------|------|------|------|------|------|------|------|------|------|
| | | | | L1 | L2 | L3 | C1 | C2 | C3 | G1 | G2 | G3 | F | E |
| 1/4 | 1/4 | 1/8 | F4-UT-F4-F2- | 26.7 | 26.7 | 24.4 | 15.2 | 15.2 | 12.7 | 14.3 | 14.3 | 11.1 | 12.7 | 2.3 |
| 3/8 | 1/4 | 1/4 | F6-UT-F4-F4- | 30.5 | 29.0 | 29.0 | 16.8 | 15.2 | 15.2 | 17.5 | 14.3 | 14.3 | 15.9 | 4.8 |
| 3/8 | 1/4 | 3/8 | F6-UT-F4-F6- | 30.5 | 29.0 | 30.5 | 16.8 | 15.2 | 16.8 | 17.5 | 14.3 | 17.5 | 15.9 | 4.8 |
| 3/8 | 3/8 | 1/4 | F6-UT-F6-F4- | 30.5 | 30.5 | 29.0 | 16.8 | 16.8 | 15.2 | 17.5 | 17.5 | 14.3 | 15.9 | 4.8 |
| 1/2 | 1/4 | 1/4 | F8-UT-F4-F4- | 36.1 | 31.8 | 31.8 | 22.9 | 15.2 | 15.2 | 22.2 | 14.3 | 14.3 | 20.6 | 4.8 |
| 1/2 | 1/4 | 1/2 | F8-UT-F4-F8- | 36.1 | 31.8 | 36.1 | 22.9 | 15.2 | 22.9 | 22.2 | 14.3 | 22.2 | 20.6 | 4.8 |
| 1/2 | 3/8 | 3/8 | F8-UT-F6-F6- | 36.1 | 33.3 | 33.3 | 22.9 | 16.8 | 16.8 | 22.2 | 17.5 | 17.5 | 20.6 | 7.1 |
| 1/2 | 3/8 | 1/2 | F8-UT-F6-F8- | 36.1 | 33.3 | 36.1 | 22.9 | 16.8 | 22.9 | 22.2 | 17.5 | 22.2 | 20.6 | 7.1 |
| 1/2 | 1/2 | 1/4 | F8-UT-F8-F4- | 36.1 | 36.1 | 31.8 | 22.9 | 22.9 | 15.2 | 22.2 | 22.2 | 14.3 | 20.6 | 4.8 |
| 1/2 | 1/2 | 3/8 | F8-UT-F8-F6- | 36.1 | 36.1 | 33.3 | 22.9 | 22.9 | 16.8 | 22.2 | 22.2 | 17.5 | 20.6 | 7.1 |
| 5/8 | 3/8 | 3/8 | F10-UT-F6-F6- | 38.9 | 36.1 | 36.1 | 24.4 | 16.8 | 16.8 | 25.4 | 17.5 | 17.5 | 25.4 | 7.1 |
| 5/8 | 3/8 | 1/2 | F10-UT-F6-F8- | 38.9 | 36.1 | 38.9 | 24.4 | 16.8 | 22.9 | 25.4 | 17.5 | 22.2 | 25.4 | 7.1 |
| 5/8 | 1/2 | 3/8 | F10-UT-F8-F6- | 38.9 | 38.9 | 36.1 | 24.4 | 22.9 | 16.8 | 25.4 | 22.2 | 17.5 | 25.4 | 7.1 |
| 5/8 | 1/2 | 1/2 | F10-UT-F8-F8- | 38.9 | 38.9 | 38.9 | 24.4 | 22.9 | 22.9 | 25.4 | 22.2 | 22.2 | 25.4 | 10.4 |
| 5/8 | 5/8 | 3/8 | F10-UT-F10-F6- | 38.9 | 38.9 | 36.1 | 24.4 | 24.4 | 16.8 | 25.4 | 25.4 | 17.5 | 25.4 | 7.1 |
| 5/8 | 5/8 | 1/2 | F10-UT-F10-F8- | 38.9 | 38.9 | 38.9 | 24.4 | 24.4 | 22.9 | 25.4 | 25.4 | 22.2 | 25.4 | 10.4 |
| 3/4 | 3/8 | 3/8 | F12-UT-F6-F6- | 39.6 | 36.9 | 36.9 | 24.4 | 16.8 | 16.8 | 28.6 | 17.5 | 17.5 | 27.0 | 7.1 |
| 3/4 | 1/2 | 3/8 | F12-UT-F8-F6- | 39.6 | 39.6 | 36.9 | 24.4 | 22.9 | 16.8 | 28.6 | 22.2 | 17.5 | 27.0 | 7.1 |
| 3/4 | 1/2 | 1/2 | F12-UT-F8-F8- | 39.6 | 39.6 | 39.6 | 24.4 | 22.9 | 22.9 | 28.6 | 22.2 | 22.2 | 27.0 | 10.4 |
| 3/4 | 5/8 | 3/8 | F12-UT-F10-F6- | 39.6 | 39.6 | 36.9 | 24.4 | 24.4 | 16.8 | 28.6 | 25.4 | 17.5 | 27.0 | 7.1 |
| 3/4 | 5/8 | 1/2 | F12-UT-F10-F8- | 39.6 | 39.6 | 39.6 | 24.4 | 24.4 | 22.9 | 28.6 | 25.4 | 22.2 | 27.0 | 10.4 |
| 3/4 | 5/8 | 5/8 | F12-UT-F10-F10- | 39.6 | 39.6 | 39.6 | 24.4 | 24.4 | 24.4 | 28.6 | 25.4 | 25.4 | 27.0 | 12.7 |
| 3/4 | 3/4 | 1/4 | F12-UT-F12-F4- | 39.6 | 39.6 | 35.1 | 24.4 | 24.4 | 15.2 | 28.6 | 28.6 | 14.3 | 27.0 | 4.8 |
| 3/4 | 3/4 | 3/8 | F12-UT-F12-F6- | 39.6 | 39.6 | 36.9 | 24.4 | 24.4 | 16.8 | 28.6 | 28.6 | 17.5 | 27.0 | 7.1 |
| 3/4 | 3/4 | 1/2 | F12-UT-F12-F8- | 39.6 | 39.6 | 39.6 | 24.4 | 24.4 | 22.9 | 28.6 | 28.6 | 22.2 | 27.0 | 10.4 |
| 3/4 | 3/4 | 5/8 | F12-UT-F12-F10- | 39.6 | 39.6 | 39.6 | 24.4 | 24.4 | 24.4 | 28.6 | 28.6 | 25.4 | 27.0 | 12.7 |
| 7/8 | 1/2 | 3/4 | F14-UT-F8-F12- | 44.7 | 44.7 | 44.7 | 25.9 | 22.9 | 24.4 | 31.8 | 22.2 | 28.6 | 34.9 | 10.4 |
| 7/8 | 5/8 | 3/8 | F14-UT-F10-F6- | 44.7 | 44.7 | 41.9 | 25.9 | 24.4 | 16.8 | 31.8 | 25.4 | 17.5 | 34.9 | 7.1 |
| 7/8 | 3/4 | 3/8 | F14-UT-F12-F6- | 44.7 | 44.7 | 41.9 | 25.9 | 24.4 | 16.8 | 31.8 | 28.6 | 17.5 | 34.9 | 7.1 |
| 7/8 | 3/4 | 1/2 | F14-UT-F12-F8- | 44.7 | 44.7 | 44.7 | 25.9 | 24.4 | 22.9 | 31.8 | 28.6 | 22.2 | 34.9 | 10.4 |
| 7/8 | 3/4 | 3/4 | F14-UT-F12-F12- | 44.7 | 44.7 | 44.7 | 25.9 | 24.4 | 24.4 | 31.8 | 28.6 | 28.6 | 34.9 | 15.7 |
| 7/8 | 7/8 | 1/4 | F14-UT-F14-F4- | 44.7 | 44.7 | 40.4 | 25.9 | 25.9 | 15.2 | 31.8 | 31.8 | 14.3 | 34.9 | 4.8 |
| 7/8 | 7/8 | 3/8 | F14-UT-F14-F6- | 44.7 | 44.7 | 41.9 | 25.9 | 25.9 | 16.8 | 31.8 | 31.8 | 17.5 | 34.9 | 7.1 |
| 1 | 3/8 | 3/8 | F16-UT-F6-F6- | 49.3 | 41.9 | 41.9 | 31.2 | 16.8 | 16.8 | 38.1 | 17.5 | 17.5 | 34.9 | 7.1 |
| 1 | 1/2 | 1/4 | F16-UT-F8-F4- | 49.3 | 44.7 | 40.4 | 31.2 | 22.9 | 15.2 | 38.1 | 22.2 | 14.3 | 34.9 | 4.8 |
| 1 | 1/2 | 3/8 | F16-UT-F8-F6- | 49.3 | 44.7 | 41.9 | 31.2 | 22.9 | 16.8 | 38.1 | 22.2 | 17.5 | 34.9 | 7.1 |
| 1 | 1/2 | 1/2 | F16-UT-F8-F8- | 49.3 | 44.7 | 44.7 | 31.2 | 22.9 | 22.9 | 38.1 | 22.2 | 22.2 | 34.9 | 10.4 |
| 1 | 1/2 | 1 | F16-UT-F8-F16- | 49.3 | 44.7 | 49.3 | 31.2 | 22.9 | 31.2 | 38.1 | 22.2 | 38.1 | 34.9 | 10.4 |
| 1 | 5/8 | 3/8 | F16-UT-F10-F6- | 49.3 | 44.7 | 41.9 | 31.2 | 24.4 | 16.8 | 38.1 | 25.4 | 17.5 | 34.9 | 7.1 |
| 1 | 3/4 | 3/8 | F16-UT-F12-F6- | 49.3 | 44.7 | 41.9 | 31.2 | 24.4 | 16.8 | 38.1 | 28.6 | 17.5 | 34.9 | 7.1 |
| 1 | 3/4 | 1/2 | F16-UT-F12-F8- | 49.3 | 44.7 | 44.7 | 31.2 | 24.4 | 22.9 | 38.1 | 28.6 | 22.2 | 34.9 | 10.4 |
| 1 | 3/4 | 5/8 | F16-UT-F12-F10- | 49.3 | 44.7 | 44.7 | 31.2 | 24.4 | 24.4 | 38.1 | 28.6 | 25.4 | 34.9 | 12.7 |
| 1 | 3/4 | 1 | F16-UT-F12-F16- | 49.3 | 44.7 | 49.3 | 31.2 | 24.4 | 31.2 | 38.1 | 28.6 | 38.1 | 34.9 | 15.7 |
| 1 | 7/8 | 1/4 | F16-UT-F14-F4- | 49.3 | 44.7 | 40.4 | 31.2 | 25.9 | 15.2 | 38.1 | 31.8 | 14.3 | 34.9 | 4.8 |
| 1 | 7/8 | 3/8 | F16-UT-F14-F6- | 49.3 | 44.7 | 41.9 | 31.2 | 25.9 | 16.8 | 38.1 | 31.8 | 17.5 | 34.9 | 7.1 |
| 1 | 7/8 | 1/2 | F16-UT-F14-F8- | 49.3 | 44.7 | 44.7 | 31.2 | 25.9 | 22.9 | 38.1 | 31.8 | 22.2 | 34.9 | 10.4 |
| 1 | 7/8 | 3/4 | F16-UT-F14-F12- | 49.3 | 44.7 | 44.7 | 31.2 | 25.9 | 24.4 | 38.1 | 31.8 | 28.6 | 34.9 | 12.7 |
| 1 | 7/8 | 7/8 | F16-UT-F14-F14- | 49.3 | 44.7 | 44.7 | 31.2 | 25.9 | 25.9 | 38.1 | 31.8 | 31.8 | 34.9 | 18.3 |
| 1 | 1 | 1/4 | F16-UT-F16-F4- | 49.3 | 49.3 | 40.4 | 31.2 | 31.2 | 15.2 | 38.1 | 38.1 | 14.3 | 34.9 | 4.8 |
| 1 | 1 | 3/8 | F16-UT-F16-F6- | 49.3 | 49.3 | 41.9 | 31.2 | 31.2 | 16.8 | 38.1 | 38.1 | 17.5 | 34.9 | 7.1 |
| 1 | 1 | 1/2 | F16-UT-F16-F8- | 49.3 | 49.3 | 44.7 | 31.2 | 31.2 | 22.9 | 38.1 | 38.1 | 22.2 | 34.9 | 10.4 |
| 1 | 1 | 5/8 | F16-UT-F16-F10- | 49.3 | 49.3 | 44.7 | 31.2 | 31.2 | 24.4 | 38.1 | 38.1 | 25.4 | 34.9 | 12.7 |
| 1 | 1 | 3/4 | F16-UT-F16-F12- | 49.3 | 49.3 | 44.7 | 31.2 | 31.2 | 24.4 | 38.1 | 38.1 | 28.6 | 34.9 | 15.7 |
| 1 | 1 | 7/8 | F16-UT-F16-F14- | 49.3 | 49.3 | 44.7 | 31.2 | 31.2 | 25.9 | 38.1 | 38.1 | 31.8 | 34.9 | 18.3 |
| 1 1/4 | 1 1/4 | 1 | F20-UT-F20-F16- | 67.8 | 67.8 | 55.1 | 41.2 | 41.2 | 31.3 | 47.6 | 47.6 | 38.1 | 42.9 | 22.4 |
| 1 1/2 | 1 1/2 | 1 | F24-UT-F24-F16- | 78.7 | 78.7 | 60.0 | 50.0 | 50.0 | 31.3 | 57.2 | 57.2 | 38.1 | 50.8 | 22.4 |

Переходной соединительный тройник

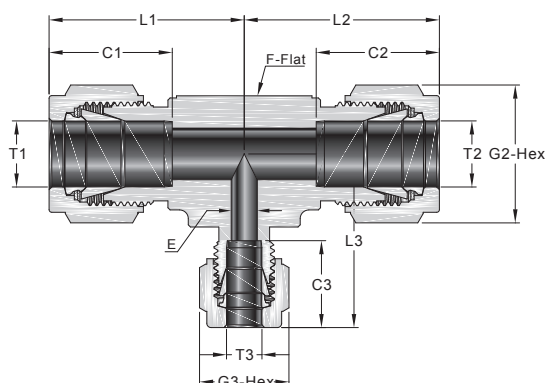

Метрическая трубка

| T1- трубка, мм | T2- трубка, мм | T3- трубка, мм | Артикул для заказа | Размеры, мм | | | | | | | | | | |
|----------------------|----------------------|----------------------|-----------------------|-------------|------|------|------|------|------|----|----|----|------|------|
| | | | | L1 | L2 | L3 | C1 | C2 | C3 | G1 | G2 | G3 | F | E |
| 3 | 3 | 6 | M3-UT-M3-M6- | 24.7 | 24.7 | 27.0 | 12.9 | 12.9 | 15.3 | 12 | 12 | 14 | 12.7 | 2.4 |
| 6 | 6 | 3 | M6-UT-M6-M3- | 27.0 | 27.0 | 25.4 | 15.3 | 15.3 | 12.9 | 14 | 14 | 12 | 12.7 | 2.4 |
| 6 | 6 | 8 | M6-UT-M6-M8- | 28.0 | 28.0 | 28.8 | 15.3 | 15.3 | 16.2 | 14 | 14 | 16 | 14.3 | 4.8 |
| 8 | 8 | 6 | M8-UT-M8-M6- | 30.0 | 30.0 | 29.0 | 16.2 | 16.2 | 15.3 | 16 | 16 | 14 | 15.9 | 4.8 |
| 8 | 8 | 12 | M8-UT-M8-M12- | 35.2 | 35.2 | 36.0 | 16.2 | 16.2 | 22.8 | 16 | 16 | 22 | 20.6 | 6.4 |
| 10 | 10 | 6 | M10-UT-M10-M6- | 31.5 | 31.5 | 29.9 | 17.2 | 17.2 | 15.3 | 19 | 19 | 14 | 17.5 | 4.8 |
| 10 | 10 | 8 | M10-UT-M10-M8- | 31.5 | 31.5 | 30.7 | 17.2 | 17.2 | 16.2 | 19 | 19 | 16 | 17.5 | 6.4 |
| 12 | 12 | 6 | M12-UT-M12-M6- | 36.0 | 36.0 | 31.8 | 22.8 | 22.8 | 15.3 | 22 | 22 | 14 | 20.6 | 4.8 |
| 12 | 12 | 8 | M12-UT-M12-M8- | 36.0 | 36.0 | 35.2 | 22.8 | 22.8 | 16.2 | 22 | 22 | 16 | 20.6 | 6.4 |
| 12 | 12 | 14 | M12-UT-M12-M14- | 38.0 | 38.0 | 38.0 | 22.8 | 22.8 | 24.4 | 22 | 22 | 25 | 25.4 | 9.5 |
| 12 | 12 | 18 | M12-UT-M12-M18- | 39.8 | 39.8 | 39.8 | 22.8 | 22.8 | 24.4 | 22 | 22 | 30 | 27.0 | 9.5 |
| 14 | 14 | 8 | M14-UT-M14-M8- | 38.0 | 38.0 | 37.2 | 24.4 | 24.4 | 16.2 | 25 | 25 | 16 | 25.4 | 6.4 |
| 14 | 14 | 10 | M14-UT-M14-M10- | 38.0 | 38.0 | 38.0 | 24.4 | 24.4 | 17.2 | 25 | 25 | 19 | 25.4 | 7.9 |
| 15 | 15 | 12 | M15-UT-M15-M12- | 38.8 | 38.8 | 38.8 | 24.4 | 24.4 | 22.8 | 25 | 25 | 22 | 25.4 | 9.5 |
| 16 | 16 | 8 | M16-UT-M16-M8- | 38.8 | 37.2 | 38.8 | 24.4 | 16.2 | 24.4 | 25 | 16 | 25 | 25.4 | 6.4 |
| 16 | 16 | 12 | M16-UT-M16-M12- | 38.8 | 38.8 | 38.9 | 24.4 | 24.4 | 22.8 | 25 | 25 | 22 | 25.4 | 9.5 |
| 18 | 18 | 8 | M18-UT-M18-M8- | 39.8 | 39.8 | 39.0 | 24.4 | 24.4 | 16.2 | 30 | 30 | 16 | 27.0 | 6.4 |
| 18 | 18 | 10 | M18-UT-M18-M10- | 39.8 | 39.8 | 39.8 | 24.4 | 24.4 | 17.2 | 30 | 30 | 19 | 27.0 | 7.9 |
| 18 | 18 | 12 | M18-UT-M18-M12- | 39.8 | 39.8 | 39.8 | 24.4 | 24.4 | 22.8 | 30 | 30 | 22 | 27.0 | 9.5 |
| 18 | 18 | 14 | M18-UT-M18-M14- | 39.8 | 39.8 | 39.8 | 24.4 | 24.4 | 24.4 | 30 | 30 | 25 | 27.0 | 11.1 |
| 20 | 20 | 14 | M20-UT-M20-M14- | 44.6 | 44.6 | 44.6 | 26.0 | 26.0 | 24.4 | 32 | 32 | 25 | 34.9 | 11.1 |
| 22 | 22 | 12 | M22-UT-M22-M12- | 44.6 | 44.6 | 44.6 | 26.0 | 26.0 | 22.8 | 32 | 32 | 22 | 34.9 | 9.5 |
| 25 | 25 | 12 | M25-UT-M25-M12- | 49.1 | 49.1 | 44.7 | 31.3 | 31.3 | 22.8 | 38 | 38 | 22 | 34.9 | 9.5 |

Соединительная крестовина

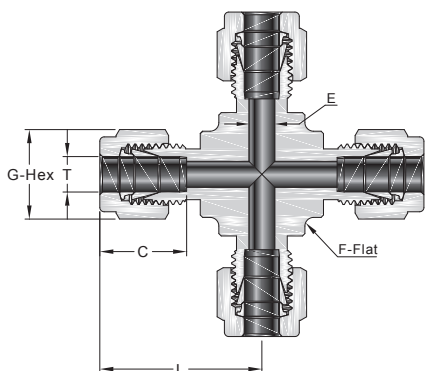

Дюймовая трубка

| Трубка, дюйм | Артикул для заказа | Размеры, мм | | | | |
|--------------|---------------------|-------------|------|------|------|------|
| | | L | C | G | F | E |
| 1/8 | F2-UC-F2-F2-F2- | 22.4 | 12.7 | 11.1 | 9.5 | 2.3 |
| 3/16 | F3-UC-F3-F3-F3- | 24.4 | 13.7 | 12.7 | 11.1 | 3.0 |
| 1/4 | F4-UC-F4-F4-F4- | 26.9 | 15.2 | 14.3 | 12.7 | 4.8 |
| 5/16 | F5-UC-F5-F5-F5- | 29.7 | 16.2 | 15.9 | 15.9 | 6.4 |
| 3/8 | F6-UC-F6-F6-F6- | 30.5 | 16.8 | 17.5 | 15.9 | 7.1 |
| 1/2 | F8-UC-F8-F8-F8- | 36.1 | 22.9 | 22.2 | 20.6 | 10.4 |
| 5/8 | F10-UC-F10-F10-F10- | 36.3 | 24.4 | 25.4 | 27.0 | 12.7 |
| 3/4 | F12-UC-F12-F12-F12- | 39.9 | 24.4 | 28.6 | 27.0 | 15.7 |
| 7/8 | F14-UC-F14-F14-F14- | 44.7 | 25.9 | 31.8 | 34.9 | 18.3 |
| 1 | F16-UC-F16-F16-F16- | 49.0 | 31.2 | 38.1 | 34.9 | 22.4 |

Метрическая трубка

| Трубка, мм | Артикул для заказа | Размеры, мм | | | | |
|------------|---------------------|-------------|------|----|------|------|
| | | L | C | G | F | E |
| 3 | M3-UC-M3-M3-M3- | 22.3 | 12.9 | 12 | 9.5 | 2.4 |
| 4 | M4-UC-M4-M4-M4- | 25.4 | 13.7 | 12 | 12.7 | 2.4 |
| 6 | M6-UC-M6-M6-M6- | 27.0 | 15.3 | 14 | 12.7 | 4.8 |
| 8 | M8-UC-M8-M8-M8- | 29.9 | 16.2 | 16 | 15.9 | 6.4 |
| 10 | M10-UC-M10-M10-M10- | 33.5 | 17.2 | 19 | 20.6 | 7.9 |
| 12 | M12-UC-M12-M12-M12- | 36.0 | 22.8 | 22 | 20.6 | 9.5 |
| 16 | M16-UC-M16-M16-M16- | 37.0 | 24.4 | 25 | 23.8 | 12.7 |
| 18 | M18-UC-M18-M18-M18- | 38.3 | 24.4 | 30 | 27.0 | 15.1 |
| 20 | M20-UC-M20-M20-M20- | 44.6 | 26.0 | 32 | 34.9 | 15.9 |
| 22 | M22-UC-M22-M22-M22- | 44.7 | 26.0 | 32 | 34.9 | 18.3 |
| 25 | M25-UC-M25-M25-M25- | 49.2 | 31.3 | 38 | 34.9 | 21.8 |

Колпак

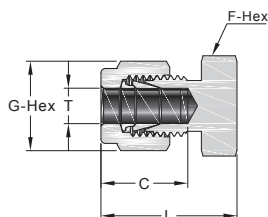

Дюймовая трубка

| Трубка, дюйм | Артикул для заказа | Размеры, мм | | | |
|--------------|--------------------|-------------|------|------|------|
| | | L | C | G | F |
| 1/16 | CA-F1- | 15.0 | 8.6 | 7.9 | 7.9 |
| 1/8 | CA-F2- | 20.1 | 12.7 | 11.1 | 11.1 |
| 3/16 | CA-F3- | 21.3 | 13.7 | 12.7 | 11.1 |
| 1/4 | CA-F4- | 23.4 | 15.2 | 14.3 | 12.7 |
| 5/16 | CA-F5- | 24.4 | 16.3 | 15.9 | 14.3 |
| 3/8 | CA-F6- | 25.7 | 16.8 | 17.5 | 15.9 |
| 1/2 | CA-F8- | 29.2 | 22.9 | 22.2 | 20.6 |
| 5/8 | CA-F10- | 30.0 | 24.4 | 25.4 | 23.8 |
| 3/4 | CA-F12- | 31.5 | 24.4 | 28.6 | 27.0 |
| 7/8 | CA-F14- | 34.0 | 25.9 | 31.8 | 30.2 |
| 1 | CA-F16- | 38.4 | 31.2 | 38.1 | 34.9 |
| 1 1/8 | CA-F18- | 38.4 | 31.2 | 46.0 | 41.3 |
| 1 1/4 | CA-F20- | 53.3 | 41.1 | 47.6 | 44.5 |
| 1 1/2 | CA-F24- | 64.5 | 50.0 | 57.2 | 54.0 |

Метрическая трубка

| Трубка, мм | Артикул для заказа | Размеры, мм | | | |
|------------|--------------------|-------------|------|----|----|
| | | L | C | G | F |
| 2 | CA-M2- | 20.1 | 12.9 | 12 | 12 |
| 3 | CA-M3- | 20.1 | 12.9 | 12 | 12 |
| 4 | CA-M4- | 21.3 | 13.7 | 12 | 12 |
| 6 | CA-M6- | 23.1 | 15.3 | 14 | 14 |
| 8 | CA-M8- | 24.5 | 16.2 | 16 | 15 |
| 10 | CA-M10- | 26.6 | 17.2 | 19 | 18 |
| 12 | CA-M12- | 29.1 | 22.8 | 22 | 22 |
| 14 | CA-M14- | 29.9 | 24.4 | 25 | 24 |
| 15 | CA-M15- | 29.9 | 24.4 | 25 | 24 |
| 16 | CA-M16- | 29.9 | 24.4 | 25 | 24 |
| 18 | CA-M18- | 31.4 | 24.4 | 30 | 27 |
| 20 | CA-M20- | 34.0 | 26.0 | 32 | 30 |
| 22 | CA-M22- | 34.0 | 26.0 | 32 | 30 |
| 25 | CA-M25- | 38.5 | 31.3 | 38 | 35 |
| 28 | CA-M28- | 48.5 | 36.6 | 46 | 41 |
| 30 | CA-M30- | 53.4 | 39.6 | 50 | 46 |
| 32 | CA-M32- | 55.8 | 42.0 | 50 | 46 |
| 38 | CA-M38- | 65.4 | 49.4 | 60 | 55 |

Заглушка

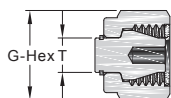

Дюймовая трубка

| Трубка, дюйм | Артикул для заказа | Размеры, мм |
|--------------|--------------------|-------------|
| | | G |
| 1/16 | PL-F1- | 7.9 |
| 1/8 | PL-F2- | 11.1 |
| 3/16 | PL-F3- | 12.7 |
| 1/4 | PL-F4- | 14.3 |
| 5/16 | PL-F5- | 15.9 |
| 3/8 | PL-F6- | 17.5 |
| 1/2 | PL-F8- | 22.2 |
| 5/8 | PL-F10- | 25.4 |
| 3/4 | PL-F12- | 28.6 |
| 7/8 | PL-F14- | 31.8 |
| 1 | PL-F16- | 38.1 |
| 1 1/4 | PL-F20- | 47.6 |
| 1 1/2 | PL-F24- | 57.2 |

Метрическая трубка

| Трубка, мм | Артикул для заказа | Размеры, мм |
|------------|--------------------|-------------|
| | | G |
| 2 | PL-M2- | 12 |
| 3 | PL-M3- | 12 |
| 4 | PL-M4- | 12 |
| 6 | PL-M6- | 14 |
| 8 | PL-M8- | 16 |
| 10 | PL-M10- | 19 |
| 12 | PL-M12- | 22 |
| 14 | PL-M14- | 25 |
| 15 | PL-M15- | 25 |
| 16 | PL-M16- | 25 |
| 18 | PL-M18- | 30 |
| 20 | PL-M20- | 32 |
| 22 | PL-M22- | 32 |
| 25 | PL-M25- | 38 |
| 28 | PL-M28- | 46 |
| 30 | PL-M30- | 50 |
| 32 | PL-M32- | 50 |
| 38 | PL-M38- | 60 |

Переходники с трубным адаптером

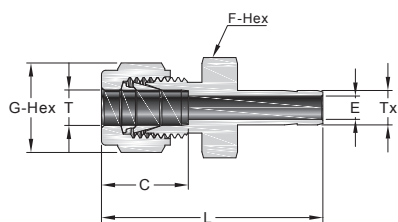

Дюймовая трубка

| Т-Трубка, дюйм | Тх-Трубка, дюйм | Артикул для заказа | Размеры, мм | | | | |
|----------------|-----------------|--------------------|-------------|------|------|------|------|
| | | | L | C | G | F | E |
| 1/16 | 1/8 | F1-R-FT2- | 29.2 | 8.6 | 7.9 | 7.9 | 1.3 |
| 1/16 | 3/16 | F1-R-FT3- | 30.0 | 8.6 | 7.9 | 7.9 | 1.3 |
| 1/16 | 1/4 | F1-R-FT4- | 31.5 | 8.6 | 7.9 | 7.9 | 1.3 |
| 1/8 | 1/16 | F2-R-FT1- | 29.0 | 12.7 | 11.1 | 11.1 | 0.8 |
| 1/8 | 1/8 | F2-R-FT2- | 33.5 | 12.7 | 11.1 | 11.1 | 2.0 |
| 1/8 | 3/16 | F2-R-FT3- | 34.3 | 12.7 | 11.1 | 11.1 | 2.3 |
| 1/8 | 1/4 | F2-R-FT4- | 36.1 | 12.7 | 11.1 | 11.1 | 2.3 |
| 1/8 | 3/8 | F2-R-FT6- | 37.6 | 12.7 | 11.1 | 11.1 | 2.3 |
| 1/8 | 1/2 | F2-R-FT8- | 44.2 | 12.7 | 11.1 | 14.3 | 2.3 |
| 3/16 | 1/8 | F3-R-FT2- | 34.8 | 13.7 | 12.7 | 11.1 | 2.0 |
| 3/16 | 1/4 | F3-R-FT4- | 37.1 | 13.7 | 12.7 | 11.1 | 3.0 |
| 1/4 | 1/8 | F4-R-FT2- | 36.8 | 15.2 | 14.3 | 12.7 | 2.0 |
| 1/4 | 3/16 | F4-R-FT3- | 37.6 | 15.2 | 14.3 | 12.7 | 3.0 |
| 1/4 | 1/4 | F4-R-FT4- | 39.1 | 15.2 | 14.3 | 12.7 | 4.3 |
| 1/4 | 5/16 | F4-R-FT5- | 39.9 | 15.2 | 14.3 | 12.7 | 4.8 |
| 1/4 | 3/8 | F4-R-FT6- | 40.6 | 15.2 | 14.3 | 12.7 | 4.8 |
| 1/4 | 1/2 | F4-R-FT8- | 46.2 | 15.2 | 14.3 | 14.3 | 4.8 |
| 1/4 | 5/8 | F4-R-FT10- | 48.0 | 15.2 | 14.3 | 17.5 | 4.8 |
| 1/4 | 3/4 | F4-R-FT12- | 47.8 | 15.2 | 14.3 | 20.6 | 4.8 |
| 5/16 | 3/8 | F5-R-FT6- | 41.9 | 16.3 | 15.9 | 14.3 | 6.4 |
| 5/16 | 1/2 | F5-R-FT8- | 47.5 | 16.3 | 15.9 | 14.3 | 6.4 |
| 3/8 | 1/4 | F6-R-FT4- | 41.4 | 16.8 | 17.5 | 15.9 | 4.3 |
| 3/8 | 3/8 | F6-R-FT6- | 43.2 | 16.8 | 17.5 | 15.9 | 6.9 |
| 3/8 | 1/2 | F6-R-FT8- | 48.5 | 16.8 | 17.5 | 15.9 | 7.1 |
| 3/8 | 5/8 | F6-R-FT10- | 50.3 | 16.8 | 17.5 | 17.5 | 7.1 |
| 3/8 | 3/4 | F6-R-FT12- | 50.3 | 16.8 | 17.5 | 20.6 | 7.1 |
| 1/2 | 1/4 | F8-R-FT4- | 45.0 | 22.9 | 22.2 | 20.6 | 4.3 |
| 1/2 | 3/8 | F8-R-FT6- | 46.7 | 22.9 | 22.2 | 20.6 | 6.9 |
| 1/2 | 1/2 | F8-R-FT8- | 52.3 | 22.9 | 22.2 | 20.6 | 9.4 |
| 1/2 | 5/8 | F8-R-FT10- | 53.8 | 22.9 | 22.2 | 20.6 | 10.4 |
| 1/2 | 3/4 | F8-R-FT12- | 53.8 | 22.9 | 22.2 | 20.6 | 10.4 |
| 1/2 | 1 | F8-R-FT16- | 60.2 | 22.9 | 22.2 | 27.0 | 10.4 |
| 5/8 | 3/4 | F10-R-FT12- | 54.6 | 24.4 | 25.4 | 23.8 | 12.7 |
| 5/8 | 7/8 | F10-R-FT14- | 56.1 | 24.4 | 25.4 | 23.8 | 12.7 |
| 5/8 | 1 | F10-R-FT16- | 61.0 | 24.4 | 25.4 | 27.0 | 12.7 |
| 3/4 | 1/2 | F12-R-FT8- | 54.6 | 24.4 | 28.6 | 27.0 | 9.4 |
| 3/4 | 3/4 | F12-R-FT12- | 54.6 | 24.4 | 28.6 | 27.0 | 14.7 |
| 3/4 | 1 | F12-R-FT16- | 62.5 | 24.4 | 28.6 | 27.0 | 15.7 |

Дюймовая трубка

| Т-Трубка, дюйм | Тх-Трубка, мм | Артикул для заказа | Размеры, мм | | | | |
|----------------|---------------|--------------------|-------------|------|------|------|-----|
| | | | L | C | G | F | E |
| 1/8 | 6 | F2-R-MT6- | 36.1 | 12.7 | 11.1 | 11.1 | 2.3 |

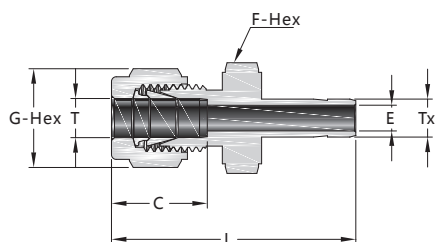
Метрическая трубка

| Т- Трубка, мм | Тх- Трубка, мм | Артикул для заказа | Размеры, мм | | | | |
|---------------------|----------------------|-----------------------|-------------|------|----|----|------|
| | | | L | C | G | F | E |
| 2 | 3 | M2-R-MT3- | 33.5 | 12.9 | 12 | 12 | 1.7 |
| 3 | 4 | M3-R-MT4- | 35.0 | 12.9 | 12 | 12 | 2.4 |
| 3 | 6 | M3-R-MT6- | 36.1 | 12.9 | 12 | 12 | 2.4 |
| 3 | 10 | M3-R-MT10- | 38.4 | 12.9 | 12 | 14 | 2.4 |
| 4 | 6 | M4-R-MT6- | 37.1 | 13.7 | 12 | 12 | 2.4 |
| 6 | 3 | M6-R-MT3- | 36.9 | 15.3 | 14 | 14 | 1.9 |
| 6 | 8 | M6-R-MT8- | 39.9 | 15.3 | 14 | 14 | 4.8 |
| 6 | 10 | M6-R-MT10- | 40.7 | 15.3 | 14 | 14 | 4.8 |
| 6 | 12 | M6-R-MT12- | 46.3 | 15.3 | 14 | 14 | 4.8 |
| 6 | 18 | M6-R-MT18- | 49.6 | 15.3 | 14 | 22 | 4.8 |
| 8 | 6 | M8-R-MT6- | 40.3 | 16.2 | 16 | 15 | 4.1 |
| 8 | 10 | M8-R-MT10- | 42.0 | 16.2 | 16 | 15 | 6.4 |
| 8 | 12 | M8-R-MT12- | 47.6 | 16.2 | 16 | 15 | 6.4 |
| 10 | 6 | M10-R-MT6- | 42.4 | 17.2 | 19 | 18 | 4.1 |
| 10 | 8 | M10-R-MT8- | 43.4 | 17.2 | 19 | 18 | 5.6 |
| 10 | 12 | M10-R-MT12- | 49.8 | 17.2 | 19 | 18 | 7.9 |
| 10 | 15 | M10-R-MT15- | 51.3 | 17.2 | 19 | 18 | 7.9 |
| 10 | 18 | M10-R-MT18- | 51.3 | 17.2 | 19 | 22 | 7.9 |
| 12 | 6 | M12-R-MT6- | 44.9 | 22.8 | 22 | 22 | 4.1 |
| 12 | 8 | M12-R-MT8- | 45.9 | 22.8 | 22 | 22 | 5.6 |
| 12 | 10 | M12-R-MT10- | 46.7 | 22.8 | 22 | 22 | 7.1 |
| 12 | 16 | M12-R-MT16- | 53.8 | 22.8 | 22 | 22 | 9.5 |
| 12 | 18 | M12-R-MT18- | 53.8 | 22.8 | 22 | 22 | 9.5 |
| 12 | 20 | M12-R-MT20- | 56.1 | 22.8 | 22 | 22 | 9.5 |
| 12 | 22 | M12-R-MT22- | 56.1 | 22.8 | 22 | 24 | 9.5 |
| 12 | 25 | M12-R-MT25- | 62.4 | 22.8 | 22 | 27 | 9.5 |
| 16 | 12 | M16-R-MT12- | 53.0 | 24.4 | 25 | 24 | 8.8 |
| 18 | 12 | M18-R-MT12- | 54.6 | 24.4 | 30 | 27 | 8.8 |
| 18 | 16 | M18-R-MT16- | 56.1 | 24.4 | 30 | 27 | 12.0 |
| 18 | 20 | M18-R-MT20- | 57.6 | 24.4 | 30 | 27 | 15.1 |
| 18 | 22 | M18-R-MT22- | 57.6 | 24.4 | 30 | 27 | 15.1 |
| 18 | 25 | M18-R-MT25- | 62.4 | 24.4 | 30 | 27 | 15.1 |
| 20 | 16 | M20-R-MT16- | 57.9 | 26.0 | 32 | 30 | 12.0 |
| 20 | 18 | M20-R-MT18- | 57.9 | 26.0 | 32 | 30 | 13.9 |
| 20 | 22 | M20-R-MT22- | 59.4 | 26.0 | 32 | 30 | 15.9 |
| 20 | 25 | M20-R-MT25- | 64.2 | 26.0 | 32 | 30 | 15.8 |
| 22 | 18 | M22-R-MT18- | 57.9 | 26.0 | 32 | 30 | 13.9 |
| 22 | 20 | M22-R-MT20- | 59.4 | 26.0 | 32 | 30 | 15.5 |
| 22 | 25 | M22-R-MT25- | 64.2 | 26.0 | 32 | 30 | 18.3 |
| 25 | 18 | M25-R-MT18- | 63.1 | 31.3 | 38 | 35 | 13.9 |
| 25 | 20 | M25-R-MT20- | 64.6 | 31.3 | 38 | 35 | 15.5 |

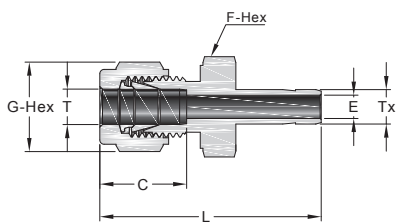

Метрическая трубка

Дюймовая трубка

| Т-Трубка, мм | Тх-Трубка, дюйм | Артикул для заказа | Размеры, мм | | | | |
|--------------|-----------------|--------------------|-------------|------|----|----|------|
| | | | L | C | G | F | E |
| 2 | 1/8 | M2-R-FT2- | 33.5 | 12.9 | 12 | 12 | 1.7 |
| 3 | 1/8 | M3-R-FT2- | 33.5 | 12.9 | 12 | 12 | 2.0 |
| 3 | 1/4 | M3-R-FT4- | 36.1 | 12.9 | 12 | 12 | 2.4 |
| 4 | 1/4 | M4-R-FT4- | 37.1 | 13.7 | 12 | 12 | 2.4 |
| 6 | 1/8 | M6-R-FT2- | 36.9 | 15.3 | 14 | 14 | 2.0 |
| 6 | 1/4 | M6-R-FT4- | 39.2 | 15.3 | 14 | 14 | 4.4 |
| 6 | 5/16 | M6-R-FT5- | 39.9 | 15.3 | 14 | 14 | 4.8 |
| 6 | 3/8 | M6-R-FT6- | 40.7 | 15.3 | 14 | 14 | 4.8 |
| 6 | 1/2 | M6-R-FT8- | 46.3 | 15.3 | 14 | 14 | 4.8 |
| 8 | 1/4 | M8-R-FT4- | 40.3 | 16.2 | 16 | 15 | 4.4 |
| 8 | 3/8 | M8-R-FT6- | 42.0 | 16.2 | 16 | 15 | 6.4 |
| 8 | 1/2 | M8-R-FT8- | 47.6 | 16.2 | 16 | 15 | 6.4 |
| 10 | 3/8 | M10-R-FT6- | 44.2 | 17.2 | 19 | 18 | 6.8 |
| 10 | 1/2 | M10-R-FT8- | 49.8 | 17.2 | 19 | 18 | 7.9 |
| 12 | 1/2 | M12-R-FT8- | 52.3 | 22.8 | 22 | 22 | 9.3 |
| 12 | 3/4 | M12-R-FT12- | 53.8 | 22.8 | 22 | 22 | 9.5 |
| 18 | 3/4 | M18-R-FT12- | 56.1 | 24.4 | 30 | 27 | 14.7 |
| 18 | 1 | M18-R-FT16- | 62.4 | 24.4 | 30 | 27 | 15.1 |
| 25 | 1 | M25-R-FT16- | 69.5 | 31.3 | 38 | 35 | 20.2 |

Соединитель для фитингов

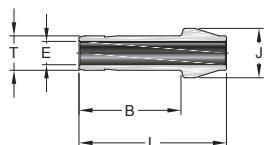

1" /25 мм и меньше

Дюймовая трубка

| Трубка, дюйм | Артикул для заказа | Размеры, мм | | | |
|--------------|----------------------|-------------|------|------|------|
| | | L | B | E | J |
| 1/16 | PC-F1- | 13.7 | 10.7 | 0.8 | 3.3 |
| 1/8 | PC-F2- | 22.4 | 15.7 | 2.0 | 6.1 |
| 1/4 | PC-F4- | 24.6 | 18.8 | 4.3 | 9.4 |
| 5/16 | PC-F5- | 25.9 | 20.1 | 5.6 | 10.9 |
| 3/8 | PC-F6- | 26.2 | 20.3 | 6.9 | 12.7 |
| 1/2 | PC-F8- | 35.8 | 25.9 | 9.4 | 15.7 |
| 5/8 | PC-F10- | 37.8 | 28.1 | 11.9 | 20.5 |
| 3/4 | PC-F12- | 37.3 | 27.7 | 14.7 | 22.1 |
| 1 | PC-F16- | 48.0 | 34.5 | 20.3 | 28.4 |
| 1 1/4 | PC-F20- ^① | 69.1 | 50.6 | 25.9 | 37.4 |
| 1 1/2 | PC-F24- ^① | 84.1 | 59.4 | 31.8 | 45.8 |

① Оснащен гайкой и предварительно обжатыми кольцами.

Метрическая трубка

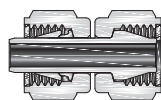

1 1/4" /28 мм и больше

| Трубка, мм | Артикул для заказа | Размеры, мм | | | |
|------------|----------------------|-------------|------|------|------|
| | | L | B | E | J |
| 3 | PC-M3- | 22.2 | 15.7 | 1.9 | 6.0 |
| 6 | PC-M6- | 24.6 | 18.7 | 4.1 | 9.0 |
| 8 | PC-M8- | 25.9 | 20.0 | 5.6 | 11.0 |
| 10 | PC-M10- | 26.1 | 20.2 | 7.1 | 13.1 |
| 12 | PC-M12- | 35.8 | 26.0 | 8.8 | 15.0 |
| 15 | PC-M15- | 37.8 | 27.6 | 11.2 | 19.6 |
| 16 | PC-M16- | 37.8 | 27.6 | 12.0 | 20.6 |
| 18 | PC-M18- | 37.8 | 27.7 | 13.9 | 21.0 |
| 20 | PC-M20- | 39.4 | 29.2 | 15.5 | 24.6 |
| 25 | PC-M25- | 49.3 | 34.5 | 19.9 | 31.2 |
| 28 | PC-M28- ^① | 63.5 | 48.3 | 22.5 | 34.4 |
| 30 | PC-M30- ^① | 67.6 | 52.2 | 24.3 | 37.4 |
| 32 | PC-M32- ^① | 69.7 | 52.4 | 26.5 | 39.4 |
| 38 | PC-M38- ^① | 81.9 | 61.4 | 31.6 | 45.8 |

① Оснащен гайкой и предварительно обжатыми кольцами.

Переходной соединитель для фитингов

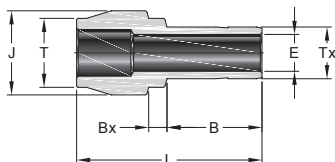

Дюймовая трубка

| Т-Трубка, дюйм | Тх-Трубка, дюйм | Артикул для заказа | Размеры, мм | | | | |
|----------------|-----------------|--------------------|-------------|------|------|-----|------|
| | | | L | B | E | Bx | J |
| 1/8 | 1/16 | F2-PC-F1- | 17.3 | 8.6 | 0.8 | 2.0 | 6.1 |
| 1/4 | 1/16 | F4-PC-F1- | 18.0 | 8.6 | 0.8 | 3.6 | 9.4 |
| 1/4 | 1/8 | F4-PC-F2- | 22.6 | 13.5 | 2.0 | 3.3 | 9.4 |
| 3/8 | 1/8 | F6-PC-F2- | 23.1 | 13.5 | 2.0 | 3.8 | 12.7 |
| 3/8 | 1/4 | F6-PC-F4- | 24.9 | 15.7 | 4.3 | 3.3 | 12.7 |
| 1/2 | 1/4 | F8-PC-F4- | 29.2 | 15.7 | 4.3 | 3.8 | 15.7 |
| 1/2 | 3/8 | F8-PC-F6- | 30.5 | 17.5 | 6.9 | 3.3 | 15.7 |
| 3/4 | 1/2 | F12-PC-F8- | 37.8 | 23.1 | 9.4 | 3.8 | 22.1 |
| 1 | 1/2 | F16-PC-F8- | 42.9 | 24.4 | 9.4 | 4.8 | 28.5 |
| 1 | 3/4 | F16-PC-F12- | 43.7 | 25.9 | 14.7 | 4.1 | 28.5 |

Метрическая трубка

| Т-Трубка, мм | Тх-Трубка, мм | Артикул для заказа | Размеры, мм | | | | |
|--------------|---------------|--------------------|-------------|------|------|------|------|
| | | | L | B | E | Bx | J |
| 6 | 3 | M6-PC-M3- | 22.6 | 13.5 | 1.9 | 3.2 | 9.0 |
| 8 | 6 | M8-PC-M6- | 24.7 | 15.7 | 4.1 | 3.1 | 11.0 |
| 10 | 6 | M10-PC-M6- | 25.0 | 15.7 | 4.1 | 3.4 | 13.1 |
| 10 | 8 | M10-PC-M8- | 26.3 | 17.0 | 5.6 | 3.1 | 13.1 |
| 12 | 6 | M12-PC-M6- | 29.6 | 15.7 | 4.1 | 3.6 | 15.0 |
| 12 | 8 | M12-PC-M8- | 29.8 | 16.8 | 5.6 | 3.4 | 15.0 |
| 12 | 10 | M12-PC-M10- | 30.4 | 17.5 | 7.1 | 3.1 | 15.0 |
| 16 | 12 | M16-PC-M12- | 36.2 | 23.1 | 8.8 | 3.4 | 19.0 |
| 28 | 25 | M28-PC-M25- | 56.5 | 33.0 | 19.8 | 8.2 | 34.3 |
| 32 | 25 | M32-PC-M25- | 60.3 | 33.0 | 19.8 | 9.9 | 39.5 |
| 38 | 25 | M38-PC-M25- | 65.8 | 33.0 | 19.8 | 12.3 | 47.1 |

Трубный адаптер с внешней резьбой

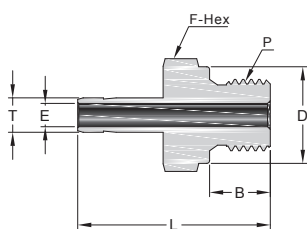

Дюймовая трубка

Цилиндрическая резьба ISO (BS)

| Трубка, дюйм | P-BS Резьба | Артикул для заказа | Размеры, дюйм (мм) | | | | |
|--------------|-------------|--------------------|--------------------|------------|------------|------------|------------|
| | | | L | B | E | F | D |
| 1/8 | 1/8 | FT2-MA-MBS2- | 1.22(31.0) | 0.28(7.1) | 0.08(2.0) | 0.56(14.3) | 0.54(13.7) |
| 1/8 | 1/4 | FT2-MA-MBS4- | 1.41(35.8) | 0.44(11.2) | 0.08(2.0) | 0.75(19.1) | 0.70(17.8) |
| 1/4 | 1/8 | FT4-MA-MBS2- | 1.31(33.3) | 0.28(7.1) | 0.16(4.1) | 0.56(14.3) | 0.54(13.7) |
| 1/4 | 1/4 | FT4-MA-MBS4- | 1.50(38.1) | 0.44(11.2) | 0.17(4.3) | 0.75(19.1) | 0.70(17.8) |
| 3/8 | 1/8 | FT6-MA-MBS2- | 1.34(34.0) | 0.28(7.1) | 0.05(1.3) | 0.56(14.3) | 0.54(13.7) |
| 3/8 | 1/4 | FT6-MA-MBS4- | 1.57(39.9) | 0.44(11.2) | 0.23(5.8) | 0.75(19.1) | 0.70(17.8) |
| 3/8 | 3/8 | FT6-MA-MBS6- | 1.60(40.6) | 0.44(11.2) | 0.27(6.9) | 0.87(22.2) | 0.85(21.6) |
| 3/8 | 1/2 | FT6-MA-MBS8- | 1.69(42.9) | 0.56(14.2) | 0.28(7.1) | 1.06(27.0) | 1.02(25.9) |
| 1/2 | 1/4 | FT8-MA-MBS4- | 1.79(45.5) | 0.44(11.2) | 0.23(5.8) | 0.75(19.1) | 0.70(17.8) |
| 1/2 | 3/8 | FT8-MA-MBS6- | 1.82(46.2) | 0.44(11.2) | 0.31(7.9) | 0.87(22.2) | 0.85(21.6) |
| 1/2 | 1/2 | FT8-MA-MBS8- | 1.94(49.2) | 0.56(14.2) | 0.37(9.4) | 1.06(27.0) | 1.02(25.9) |
| 5/8 | 1/2 | FT10-MA-MBS8- | 1.97(50.0) | 0.56(14.2) | 0.47(11.9) | 1.06(27.0) | 1.02(25.9) |
| 3/4 | 3/4 | FT12-MA-MBS12- | 2.16(54.9) | 0.63(16.0) | 0.58(14.7) | 1.31(33.3) | 1.26(32.0) |
| 1 | 1 | FT16-MA-MBS16- | 2.54(64.5) | 0.72(18.3) | 0.80(20.3) | 1.63(41.3) | 1.53(38.9) |

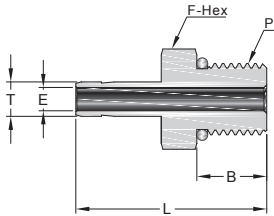
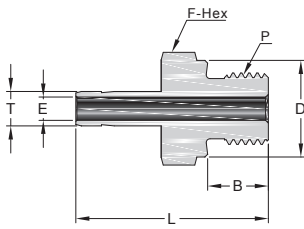

1" и меньше

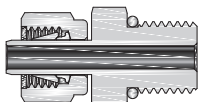

1 1/4" и больше

Адаптер по стандартам SAE J1926-1, ISO 11926-1 и MS 16142.

Трубный адаптер с внешней резьбой

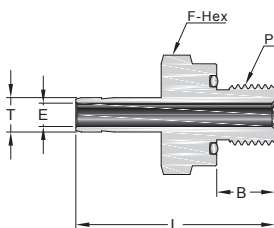
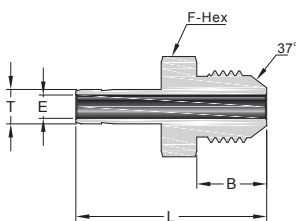

Дюймовая трубка

Цилиндрическая резьба ISO (BP)

| Трубка, дюйм | P-ВР Резьба | Артикул для заказа | Размеры, дюйм (мм) | | | | |
|--------------|-------------|--------------------|--------------------|------------|------------|------------|------------|
| | | | L | B | E | F | D |
| 1/8 | 1/8 | FT2-MA-PMBP2- | 1.09(27.7) | 0.28(7.1) | 0.05(1.3) | 0.56(14.3) | 0.54(13.7) |
| 1/8 | 1/4 | FT2-MA-PMBP4- | 1.31(33.3) | 0.44(11.2) | 0.05(1.3) | 0.75(19.1) | 0.70(17.8) |
| 1/4 | 1/8 | FT4-MA-PMBP2- | 1.19(30.2) | 0.28(7.1) | 0.16(4.1) | 0.56(14.3) | 0.54(13.7) |
| 1/4 | 1/4 | FT4-MA-PMBP4- | 1.50(38.1) | 0.44(11.2) | 0.18(4.6) | 0.75(19.1) | 0.70(17.8) |
| 3/8 | 1/8 | FT6-MA-PMBP2- | 1.34(34.0) | 0.28(7.1) | 0.05(1.3) | 0.75(19.1) | 0.54(13.7) |
| 3/8 | 1/4 | FT6-MA-PMBP4- | 1.47(37.3) | 0.44(11.2) | 0.25(6.4) | 0.75(19.1) | 0.70(17.8) |
| 3/8 | 3/8 | FT6-MA-PMBP6- | 1.50(38.1) | 0.44(11.2) | 0.28(7.1) | 0.87(22.2) | 0.85(21.6) |
| 3/8 | 1/2 | FT6-MA-PMBP8- | 1.69(42.9) | 0.56(14.2) | 0.28(7.1) | 1.06(27.0) | 1.02(25.9) |
| 1/2 | 1/4 | FT8-MA-PMBP4- | 1.69(42.9) | 0.44(11.2) | 0.25(6.4) | 0.75(19.1) | 0.70(17.8) |
| 1/2 | 3/8 | FT8-MA-PMBP6- | 1.72(43.7) | 0.44(11.2) | 0.31(7.9) | 0.87(22.2) | 0.85(21.6) |
| 1/2 | 1/2 | FT8-MA-PMBP8- | 1.94(49.3) | 0.56(14.2) | 0.39(9.9) | 1.06(27.0) | 1.02(25.9) |
| 5/8 | 1/2 | FT10-MA-PMBP8- | 1.97(50.0) | 0.56(14.2) | 0.47(11.9) | 1.06(27.0) | 1.02(25.9) |
| 3/4 | 3/4 | FT12-MA-PMBP12- | 2.09(53.1) | 0.63(16.0) | 0.58(14.7) | 1.32(33.5) | 1.26(32.0) |
| 1 | 1 | FT16-MA-PMBP16- | 2.49(63.3) | 0.72(18.3) | 0.80(20.3) | 1.63(41.3) | 1.53(38.9) |

Дюймовая трубка

Прямая резьба SAE/MS

| Трубка, дюйм | P-SAE/MS Резьба | Артикул для заказа | Размеры, дюйм (мм) | | | |
|--------------|-----------------|-----------------------------|--------------------|------------|------------|------------|
| | | | L | B | E | F |
| 1/8 | 5/16-24 | FT2-MA-OST5- | 1.20(30.5) | 0.30(7.6) | 0.08(2.0) | 0.44(11.1) |
| 1/4 | 7/16-20 | FT4-MA-OST7- | 1.39(35.3) | 0.36(9.1) | 0.17(4.3) | 0.56(14.3) |
| 3/8 | 7/16-20 | FT6-MA-OST7- | 1.46(37.1) | 0.36(9.1) | 0.20(5.1) | 0.56(14.3) |
| 3/8 | 9/16-18 | FT6-MA-OST9- | 1.52(38.6) | 0.39(9.9) | 0.27(6.9) | 0.69(17.5) |
| 3/8 | 3/4-16 | FT6-MA-OST12- | 1.60(40.6) | 0.44(11.2) | 0.27(6.9) | 0.87(22.2) |
| 1/2 | 9/16-18 | FT8-MA-OST9- | 1.74(44.2) | 0.39(9.9) | 0.28(7.1) | 0.69(17.5) |
| 1/2 | 3/4-16 | FT8-MA-OST12- | 1.82(46.2) | 0.44(11.2) | 0.37(9.4) | 0.87(22.2) |
| 5/8 | 7/8-14 | FT10-MA-OST14- | 1.94(49.3) | 0.50(12.7) | 0.47(11.9) | 1.00(25.4) |
| 3/4 | 1 1/16-12 | FT12-MA-OST17- | 2.10(53.3) | 0.59(15.0) | 0.58(14.7) | 1.25(31.8) |
| 1 | 1 5/16-12 | FT16-MA-OST21- | 2.41(61.2) | 0.59(15.0) | 0.80(20.3) | 1.50(38.1) |
| 1 1/4 | 1 5/8-12 | FT20-MA-OST26- [®] | 2.81(71.4) | 0.59(15.0) | 1.02(25.9) | 1.87(47.6) |
| 1 1/2 | 1 7/8-12 | FT24-MA-OST30- [®] | 3.28(83.3) | 0.59(15.0) | 1.25(31.8) | 2.13(54.0) |

① Оснащен гайкой и предварительно обжатыми кольцами.

Дюймовая трубка

AN резьба 37°

| Трубка, дюйм | Размер резьбы AN | Артикул для заказа | Размеры, дюйм (мм) | | | |
|--------------|------------------|--------------------|--------------------|------------|------------|------------|
| | | | L | B | E | F |
| 1/4 | 1/4 | FT4-MA-AN4- | 1.46(37.1) | 0.55(14.0) | 0.17(4.3) | 0.50(12.7) |
| 3/8 | 1/4 | FT6-MA-AN4- | 1.53(38.9) | 0.55(14.0) | 0.17(4.3) | 0.50(12.7) |
| 3/8 | 3/8 | FT6-MA-AN6- | 1.56(39.6) | 0.56(14.2) | 0.27(6.9) | 0.63(15.9) |
| 1/2 | 1/2 | FT8-MA-AN8- | 1.91(48.5) | 0.66(16.8) | 0.37(9.4) | 0.81(20.6) |
| 3/4 | 3/4 | FT12-MA-AN12- | 2.21(56.1) | 0.86(21.8) | 0.58(14.7) | 1.13(28.6) |
| 1 | 1 | FT16-MA-AN16- | 2.58(65.5) | 0.91(23.1) | 0.80(20.3) | 1.37(34.9) |

Дюймовая трубка

Прямая резьба SAE/MS с уплотнением

| Трубка, дюйм | P-SAE/MS Резьба | Артикул для заказа | Размеры, дюйм (мм) | | | |
|--------------|-----------------|--------------------|--------------------|------------|-----------|------------|
| | | | L | B | E | F |
| 1/8 | 5/16-24 | FT2-MA-STO5- | 1.28(32.5) | 0.34(8.6) | 0.08(2.0) | 0.56(14.3) |
| 3/16 | 3/8-24 | FT3-MA-STO6- | 1.38(35.1) | 0.38(9.7) | 0.12(3.0) | 0.63(15.9) |
| 1/4 | 7/16-20 | FT4-MA-STO7- | 1.54(39.1) | 0.41(10.4) | 0.17(4.3) | 0.75(19.1) |
| 5/16 | 1/2-20 | FT5-MA-STO8- | 1.64(41.7) | 0.44(11.2) | 0.22(5.6) | 0.87(22.2) |
| 3/8 | 9/16-18 | FT6-MA-STO9- | 1.70(43.2) | 0.47(11.9) | 0.27(6.9) | 0.94(23.8) |
| 1/2 | 3/4-16 | FT8-MA-STO12- | 1.95(49.5) | 0.47(11.9) | 0.37(9.4) | 1.13(28.6) |

Трубный адаптер с внешней резьбой

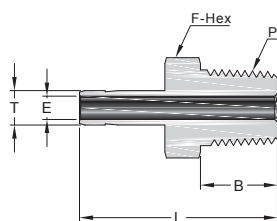

1" и меньше



1 1/4" и больше

Дюймовая трубка

Резьба NPT

| Трубка, дюйм | P-NPT Резьба | Артикул для заказа | Размеры, дюйм (мм) | | | |
|--------------|--------------|-----------------------------|--------------------|------------|------------|------------|
| | | | L | B | E | F |
| 1/16 | 1/8 | FT1-MA-NPT2- | 1.00(25.4) | 0.38(9.7) | 0.03(0.8) | 0.44(11.1) |
| 1/8 | 1/8 | FT2-MA-NPT2- | 1.16(29.5) | 0.38(9.7) | 0.08(2.0) | 0.44(11.1) |
| 1/8 | 1/4 | FT2-MA-NPT4- | 1.37(34.8) | 0.56(14.2) | 0.08(2.0) | 0.56(14.3) |
| 3/16 | 1/8 | FT3-MA-NPT2- | 1.19(30.2) | 0.38(9.7) | 0.12(3.0) | 0.44(11.1) |
| 3/16 | 1/4 | FT3-MA-NPT4- | 1.40(35.6) | 0.56(14.2) | 0.12(3.0) | 0.56(14.3) |
| 1/4 | 1/8 | FT4-MA-NPT2- | 1.25(31.8) | 0.38(9.7) | 0.17(4.3) | 0.44(11.1) |
| 1/4 | 1/4 | FT4-MA-NPT4- | 1.46(37.1) | 0.56(14.2) | 0.17(4.3) | 0.56(14.3) |
| 1/4 | 3/8 | FT4-MA-NPT6- | 1.49(37.8) | 0.56(14.2) | 0.17(4.3) | 0.69(17.5) |
| 1/4 | 1/2 | FT4-MA-NPT8- | 1.71(43.4) | 0.75(19.1) | 0.17(4.3) | 0.87(22.2) |
| 5/16 | 1/8 | FT5-MA-NPT2- | 1.29(32.8) | 0.38(9.7) | 0.19(4.8) | 0.44(11.1) |
| 5/16 | 1/4 | FT5-MA-NPT4- | 1.50(38.1) | 0.56(14.2) | 0.22(5.6) | 0.56(14.3) |
| 5/16 | 3/8 | FT5-MA-NPT6- | 1.53(38.9) | 0.56(14.2) | 0.22(5.6) | 0.69(17.5) |
| 5/16 | 1/2 | FT5-MA-NPT8- | 1.74(44.2) | 0.75(19.1) | 0.22(5.6) | 0.87(22.2) |
| 3/8 | 1/8 | FT6-MA-NPT2- | 1.32(33.5) | 0.38(9.7) | 0.19(4.8) | 0.44(11.1) |
| 3/8 | 1/4 | FT6-MA-NPT4- | 1.53(38.9) | 0.56(14.2) | 0.27(6.9) | 0.56(14.3) |
| 3/8 | 3/8 | FT6-MA-NPT6- | 1.56(39.6) | 0.56(14.2) | 0.27(6.9) | 0.69(17.5) |
| 3/8 | 1/2 | FT6-MA-NPT8- | 1.78(45.2) | 0.75(19.1) | 0.27(6.9) | 0.87(22.2) |
| 1/2 | 1/4 | FT8-MA-NPT4- | 1.75(44.5) | 0.56(14.2) | 0.28(7.1) | 0.56(14.3) |
| 1/2 | 3/8 | FT8-MA-NPT6- | 1.78(45.2) | 0.56(14.2) | 0.37(9.4) | 0.69(17.5) |
| 1/2 | 1/2 | FT8-MA-NPT8- | 2.00(50.8) | 0.75(19.1) | 0.37(9.4) | 0.87(22.2) |
| 5/8 | 1/2 | FT10-MA-NPT8- | 2.06(52.3) | 0.75(19.1) | 0.47(11.9) | 0.87(22.2) |
| 3/4 | 1/2 | FT12-MA-NPT8- | 2.06(52.3) | 0.75(19.1) | 0.47(11.9) | 0.87(22.2) |
| 3/4 | 3/4 | FT12-MA-NPT12- | 2.06(52.3) | 0.75(19.1) | 0.58(14.7) | 1.06(27.0) |
| 3/4 | 1 | FT12-MA-NPT16- | 2.41(61.2) | 0.94(23.9) | 0.81(20.7) | 1.37(34.9) |
| 1 | 3/4 | FT16-MA-NPT12- | 2.31(58.7) | 0.75(19.1) | 0.62(15.7) | 1.06(27.0) |
| 1 | 1 | FT16-MA-NPT16- | 2.60(66.0) | 0.94(23.9) | 0.80(20.3) | 1.37(34.9) |
| 1 1/4 | 1 1/4 | FT20-MA-NPT20- [Ⓢ] | 3.16(80.3) | 0.94(23.9) | 1.02(25.9) | 1.75(44.5) |
| 1 1/2 | 1 1/2 | FT24-MA-NPT24- [Ⓢ] | 3.72(94.5) | 1.03(26.2) | 1.25(31.8) | 2.13(54.0) |

Ⓢ Оснащен гайкой и предварительно обжатými кольцами.

Дюймовая трубка

Коническая резьба ISO (BSPT)

| Трубка, дюйм | P-BSPT Резьба | Артикул для заказа | Размеры, дюйм (мм) | | | |
|--------------|---------------|--------------------|--------------------|------------|------------|------------|
| | | | L | B | E | F |
| 1/8 | 1/8 | FT2-MA-MBT2- | 1.16(29.5) | 0.38(9.7) | 0.08(2.0) | 0.44(11.1) |
| 1/8 | 1/4 | FT2-MA-MBT4- | 1.37(34.8) | 0.56(14.2) | 0.08(2.0) | 0.56(14.3) |
| 1/4 | 1/8 | FT4-MA-MBT2- | 1.25(31.8) | 0.38(9.7) | 0.17(4.3) | 0.44(11.1) |
| 1/4 | 1/4 | FT4-MA-MBT4- | 1.46(37.1) | 0.56(14.2) | 0.17(4.3) | 0.56(14.3) |
| 1/4 | 3/8 | FT4-MA-MBT6- | 1.49(37.8) | 0.56(14.2) | 0.17(4.3) | 0.69(17.5) |
| 1/4 | 1/2 | FT4-MA-MBT8- | 1.71(43.4) | 0.75(19.1) | 0.17(4.3) | 0.87(22.2) |
| 5/16 | 1/8 | FT5-MA-MBT2- | 1.29(32.8) | 0.38(9.7) | 0.19(4.8) | 0.44(11.1) |
| 5/16 | 1/4 | FT5-MA-MBT4- | 1.50(38.1) | 0.56(14.2) | 0.22(5.6) | 0.56(14.3) |
| 3/8 | 1/4 | FT6-MA-MBT4- | 1.53(38.9) | 0.56(14.2) | 0.27(6.9) | 0.56(14.3) |
| 3/8 | 3/8 | FT6-MA-MBT6- | 1.56(39.6) | 0.56(14.2) | 0.27(6.9) | 0.69(17.5) |
| 3/8 | 1/2 | FT6-MA-MBT8- | 1.78(45.2) | 0.75(19.1) | 0.27(6.9) | 0.87(22.2) |
| 1/2 | 1/4 | FT8-MA-MBT4- | 1.75(44.5) | 0.56(14.2) | 0.28(7.1) | 0.56(14.3) |
| 1/2 | 3/8 | FT8-MA-MBT6- | 1.78(45.2) | 0.56(14.2) | 0.37(9.4) | 0.69(17.5) |
| 1/2 | 1/2 | FT8-MA-MBT8- | 2.00(50.8) | 0.75(19.1) | 0.37(9.4) | 0.87(22.2) |
| 5/8 | 3/8 | FT10-MA-MBT6- | 1.91(48.5) | 0.56(14.2) | 0.37(9.5) | 0.69(17.5) |
| 5/8 | 1/2 | FT10-MA-MBT8- | 2.06(52.3) | 0.75(19.1) | 0.47(11.9) | 0.87(22.2) |
| 3/4 | 3/4 | FT12-MA-MBT12- | 2.06(52.3) | 0.75(19.1) | 0.58(14.7) | 1.06(27.0) |
| 1 | 1 | FT16-MA-MBT16- | 2.60(66.0) | 0.94(23.9) | 0.80(20.3) | 1.37(34.9) |

Трубный адаптер с внешней резьбой

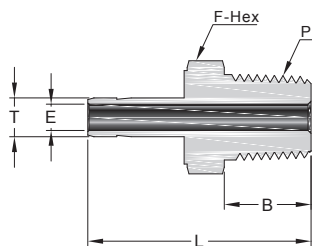

25 мм и меньше

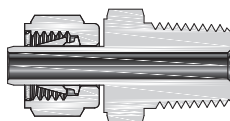

28 мм и больше

Метрическая трубка

Резьба NPT

| Трубка, мм | P-NPT резьба | Артикул для заказа | Размеры, дюйм (мм) | | | |
|------------|--------------|-----------------------------|--------------------|------------|------------|------------|
| | | | L | B | E | F |
| 3 | 1/8 | MT3-MA-NPT2- | 29.4(1.16) | 9.7(0.38) | 1.8(0.07) | 12.0(0.47) |
| 4 | 1/8 | MT4-MA-NPT2- | 29.4(1.16) | 9.7(0.38) | 2.0(0.08) | 12.0(0.47) |
| 6 | 1/8 | MT6-MA-NPT2- | 32.8(1.29) | 9.7(0.38) | 4.1(0.16) | 12.0(0.47) |
| 6 | 1/4 | MT6-MA-NPT4- | 38.1(1.50) | 14.2(0.56) | 4.1(0.16) | 14.0(0.55) |
| 6 | 3/8 | MT6-MA-NPT6- | 39.2(1.54) | 14.2(0.56) | 4.1(0.16) | 18.0(0.71) |
| 6 | 1/2 | MT6-MA-NPT8- | 42.1(1.66) | 19.1(0.75) | 4.1(0.16) | 22.0(0.87) |
| 8 | 1/4 | MT8-MA-NPT4- | 39.1(1.54) | 14.2(0.56) | 5.6(0.22) | 14.0(0.55) |
| 8 | 3/8 | MT8-MA-NPT6- | 39.9(1.57) | 14.2(0.56) | 5.6(0.22) | 19.0(0.75) |
| 10 | 1/4 | MT10-MA-NPT4- | 39.9(1.57) | 14.2(0.56) | 7.1(0.28) | 14.0(0.55) |
| 10 | 3/8 | MT10-MA-NPT6- | 40.6(1.60) | 14.2(0.56) | 7.1(0.28) | 18.0(0.71) |
| 10 | 1/2 | MT10-MA-NPT8- | 46.2(1.82) | 19.1(0.75) | 7.1(0.28) | 22.0(0.87) |
| 12 | 1/4 | MT12-MA-NPT4- | 46.5(1.83) | 14.2(0.56) | 7.1(0.28) | 14.0(0.55) |
| 12 | 3/8 | MT12-MA-NPT6- | 46.2(1.82) | 14.2(0.56) | 8.8(0.35) | 18.0(0.71) |
| 12 | 1/2 | MT12-MA-NPT8- | 52.1(2.05) | 19.1(0.75) | 8.8(0.35) | 22.0(0.87) |
| 16 | 1/2 | MT16-MA-NPT8- | 50.8(2.00) | 19.1(0.75) | 12.7(0.50) | 22.0(0.87) |
| 16 | 3/4 | MT16-MA-NPT12- | 51.6(2.03) | 19.1(0.75) | 12.7(0.50) | 27.0(1.06) |
| 18 | 1/2 | MT18-MA-NPT8- | 50.8(2.00) | 19.1(0.75) | 12.7(0.50) | 27.0(1.06) |
| 18 | 3/4 | MT18-MA-NPT12- | 51.6(2.03) | 19.1(0.75) | 14.0(0.55) | 27.0(1.06) |
| 20 | 1/2 | MT20-MA-NPT8- | 51.8(2.04) | 19.1(0.75) | 11.9(0.47) | 22.0(0.87) |
| 20 | 3/4 | MT20-MA-NPT12- | 52.4(2.06) | 19.1(0.75) | 15.1(0.59) | 27.0(1.06) |
| 25 | 1 | MT25-MA-NPT16- | 65.9(2.59) | 23.9(0.94) | 19.8(0.78) | 35.0(1.38) |
| 28 | 1 | MT28-MA-NPT16- ^① | 74.4(2.93) | 23.9(0.94) | 22.2(0.87) | 35.0(1.38) |
| 28 | 1 1/4 | MT28-MA-NPT20- ^① | 76.2(3.00) | 23.9(0.94) | 22.5(0.89) | 46.0(1.81) |
| 30 | 1 | MT30-MA-NPT16- ^① | 79.2(3.12) | 23.9(0.94) | 22.2(0.87) | 41.0(1.61) |
| 30 | 1 1/4 | MT30-MA-NPT20- ^① | 80.0(3.15) | 23.9(0.94) | 24.3(0.96) | 46.0(1.81) |
| 32 | 1 1/4 | MT32-MA-NPT20- ^① | 81.0(3.19) | 23.9(0.94) | 26.5(1.04) | 46.0(1.81) |
| 38 | 1 1/2 | MT38-MA-NPT24- ^① | 92.2(3.63) | 26.2(1.03) | 31.6(1.24) | 55.0(2.17) |

① Оснащен гайкой и предварительно обжатыми кольцами.

Метрическая трубка

Коническая резьба ISO (BSPT)

| Трубка, мм | P-BSPT Резьба | Артикул для заказа | Размеры, дюйм (мм) | | | |
|------------|---------------|-----------------------------|--------------------|------------|------------|------------|
| | | | L | B | E | F |
| 3 | 1/8 | MT3-MA-MBT2- | 29.4(1.16) | 9.7(0.38) | 1.8(0.07) | 12.0(0.47) |
| 4 | 1/8 | MT4-MA-MBT2- | 29.4(1.16) | 9.7(0.38) | 2.0(0.08) | 12.0(0.47) |
| 6 | 1/8 | MT6-MA-MBT2- | 32.8(1.29) | 9.7(0.38) | 4.1(0.16) | 12.0(0.47) |
| 6 | 1/4 | MT6-MA-MBT4- | 38.1(1.50) | 14.2(0.56) | 4.1(0.16) | 14.0(0.55) |
| 8 | 1/4 | MT8-MA-MBT4- | 39.1(1.54) | 14.2(0.56) | 5.6(0.22) | 14.0(0.55) |
| 8 | 3/8 | MT8-MA-MBT6- | 39.9(1.57) | 14.2(0.56) | 5.6(0.22) | 18.0(0.71) |
| 10 | 1/4 | MT10-MA-MBT4- | 39.9(1.57) | 14.2(0.56) | 7.1(0.28) | 14.0(0.55) |
| 10 | 3/8 | MT10-MA-MBT6- | 40.6(1.60) | 14.2(0.56) | 7.1(0.28) | 18.0(0.71) |
| 10 | 1/2 | MT10-MA-MBT8- | 44.5(1.75) | 19.1(0.75) | 7.5(0.30) | 22.0(0.87) |
| 12 | 1/4 | MT12-MA-MBT4- | 46.5(1.83) | 14.2(0.56) | 7.1(0.28) | 16.0(0.63) |
| 12 | 3/8 | MT12-MA-MBT6- | 46.2(1.82) | 14.2(0.56) | 8.8(0.35) | 18.0(0.71) |
| 12 | 1/2 | MT12-MA-MBT8- | 51.8(2.04) | 19.1(0.75) | 8.8(0.35) | 22.0(0.87) |
| 16 | 1/2 | MT16-MA-MBT8- | 50.8(2.00) | 19.1(0.75) | 12.7(0.50) | 22.0(0.87) |
| 18 | 3/4 | MT18-MA-MBT12- | 51.6(2.03) | 19.1(0.75) | 14.0(0.55) | 27.0(1.06) |
| 20 | 3/4 | MT20-MA-MBT12- | 52.4(2.06) | 19.1(0.75) | 15.1(0.59) | 27.0(1.06) |
| 25 | 1 | MT25-MA-MBT16- | 65.9(2.59) | 23.9(0.94) | 19.8(0.78) | 35.0(1.38) |
| 28 | 1 | MT28-MA-MBT16- ^① | 74.7(2.94) | 23.9(0.94) | 22.2(0.87) | 35.0(1.38) |
| 28 | 1 1/4 | MT28-MA-MBT20- ^① | 76.2(3.00) | 23.9(0.94) | 22.5(0.89) | 46.0(1.81) |
| 30 | 1 1/4 | MT30-MA-MBT20- ^① | 80.0(3.15) | 23.9(0.94) | 24.3(0.96) | 46.0(1.81) |
| 32 | 1 1/4 | MT32-MA-MBT20- ^① | 81.0(3.19) | 23.9(0.94) | 26.5(1.04) | 46.0(1.81) |
| 38 | 1 1/2 | MT38-MA-MBT24- ^① | 92.2(3.63) | 26.2(1.03) | 31.6(1.24) | 55.0(2.17) |

① Оснащен гайкой и предварительно обжатыми кольцами.

Трубный адаптер с внешней резьбой

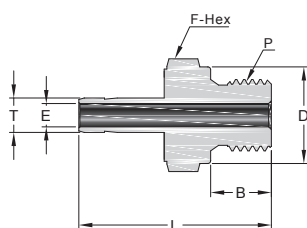

25 мм и меньше

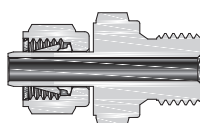

28 мм и больше

Метрическая трубка

Цилиндрическая резьба ISO (BS)

| Трубка, мм | P-BS Резьба | Артикул для заказа | Размеры, дюйм (мм) | | | | |
|------------|-------------|-----------------------------|--------------------|------------|------------|------------|------------|
| | | | L | B | E | F | D |
| 3 | 1/8 | MT3-MA-MBS2- | 31.0(1.22) | 7.1(0.28) | 1.8(0.07) | 14.0(0.55) | 13.7(0.54) |
| 4 | 1/8 | MT4-MA-MBS2- | 31.8(1.25) | 7.1(0.28) | 2.0(0.08) | 14.0(0.55) | 13.7(0.54) |
| 6 | 1/8 | MT6-MA-MBS2- | 34.3(1.35) | 7.1(0.28) | 4.0(0.16) | 14.0(0.55) | 13.7(0.54) |
| 6 | 1/4 | MT6-MA-MBS4- | 39.1(1.54) | 11.2(0.44) | 4.1(0.16) | 19.0(0.75) | 17.8(0.70) |
| 8 | 1/4 | MT8-MA-MBS4- | 40.1(1.58) | 11.2(0.44) | 5.6(0.22) | 19.0(0.75) | 17.8(0.70) |
| 10 | 1/4 | MT10-MA-MBS4- | 40.9(1.61) | 11.2(0.44) | 5.9(0.23) | 19.0(0.75) | 17.8(0.70) |
| 10 | 3/8 | MT10-MA-MBS6- | 41.7(1.64) | 11.2(0.44) | 7.1(0.28) | 22.0(0.87) | 21.6(0.85) |
| 10 | 1/2 | MT10-MA-MBS8- | 44.7(1.76) | 14.2(0.56) | 7.1(0.28) | 27.0(1.06) | 25.9(1.02) |
| 12 | 1/4 | MT12-MA-MBS4- | 46.7(1.84) | 11.2(0.44) | 5.9(0.23) | 19.0(0.75) | 17.8(0.70) |
| 12 | 3/8 | MT12-MA-MBS6- | 47.2(1.86) | 11.2(0.44) | 7.9(0.31) | 22.0(0.87) | 21.6(0.85) |
| 12 | 1/2 | MT12-MA-MBS8- | 50.5(1.99) | 14.2(0.56) | 8.8(0.35) | 27.0(1.06) | 25.9(1.02) |
| 16 | 1/2 | MT16-MA-MBS8- | 50.8(2.00) | 14.2(0.56) | 11.9(0.47) | 27.0(1.06) | 25.9(1.02) |
| 18 | 3/4 | MT18-MA-MBS12- | 55.9(2.20) | 16.0(0.63) | 13.9(0.55) | 35.0(1.38) | 32.0(1.26) |
| 20 | 3/4 | MT20-MA-MBS12- | 57.0(2.24) | 16.0(0.63) | 15.1(0.59) | 35.0(1.38) | 32.0(1.26) |
| 25 | 1 | MT25-MA-MBS16- | 65.1(2.56) | 18.3(0.72) | 19.8(0.78) | 41.0(1.61) | 38.9(1.53) |
| 28 | 1 | MT28-MA-MBS16- [ⓐ] | 72.9(2.87) | 18.3(0.72) | 19.8(0.78) | 41.0(1.61) | 38.9(1.53) |
| 28 | 1 1/4 | MT28-MA-MBS20- [ⓐ] | 77.0(3.03) | 19.8(0.78) | 22.5(0.89) | 50.0(1.97) | 49.0(1.93) |
| 30 | 1 1/4 | MT30-MA-MBS20- [ⓐ] | 80.8(3.18) | 19.8(0.78) | 24.3(0.96) | 50.0(1.97) | 49.0(1.93) |
| 32 | 1 1/4 | MT32-MA-MBS20- [ⓐ] | 81.8(3.22) | 19.8(0.78) | 26.5(1.04) | 50.0(1.97) | 49.0(1.93) |
| 38 | 1 1/2 | MT38-MA-MBS24- [ⓐ] | 94.5(3.72) | 22.1(0.87) | 31.6(1.24) | 55.0(2.17) | 54.7(2.15) |

ⓐ Оснащен гайкой и предварительно обжатыми кольцами.

Метрическая трубка

Цилиндрическая резьба ISO (BP)

| Трубка, мм | P-BP Резьба | Артикул для заказа | Размеры, дюйм (мм) | | | | |
|------------|-------------|------------------------------|--------------------|------------|------------|------------|------------|
| | | | L | B | E | F | D |
| 3 | 1/8 | MT3-MA-PMBP2- | 31.0(1.22) | 7.1(0.28) | 1.8(0.07) | 14.0(0.55) | 13.7(0.54) |
| 4 | 1/8 | MT4-MA-PMBP2- | 31.8(1.25) | 7.1(0.28) | 2.0(0.08) | 14.0(0.55) | 13.7(0.54) |
| 6 | 1/8 | MT6-MA-PMBP2- | 33.3(1.31) | 7.1(0.28) | 4.0(0.16) | 14.0(0.55) | 13.7(0.54) |
| 6 | 1/4 | MT6-MA-PMBP4- | 38.1(1.50) | 11.2(0.44) | 4.0(0.16) | 19.0(0.75) | 17.8(0.70) |
| 8 | 1/4 | MT8-MA-PMBP4- | 38.9(1.53) | 11.2(0.44) | 6.4(0.25) | 19.0(0.75) | 17.8(0.70) |
| 10 | 1/4 | MT10-MA-PMBP4- | 38.9(1.53) | 11.2(0.44) | 6.4(0.25) | 19.0(0.75) | 17.8(0.70) |
| 10 | 3/8 | MT10-MA-PMBP6- | 39.7(1.56) | 11.2(0.44) | 7.5(0.30) | 22.0(0.87) | 21.6(0.85) |
| 10 | 1/2 | MT10-MA-PMBP8- | 42.9(1.69) | 14.2(0.56) | 7.5(0.30) | 27.0(1.06) | 25.9(1.02) |
| 12 | 1/4 | MT12-MA-PMBP4- | 43.7(1.72) | 11.2(0.44) | 6.4(0.25) | 19.0(0.75) | 17.8(0.70) |
| 12 | 3/8 | MT12-MA-PMBP6- | 44.5(1.75) | 11.2(0.44) | 7.9(0.31) | 22.0(0.87) | 21.6(0.85) |
| 12 | 1/2 | MT12-MA-PMBP8- | 49.2(1.94) | 14.2(0.56) | 9.1(0.36) | 27.0(1.06) | 25.9(1.02) |
| 16 | 1/2 | MT16-MA-PMBP8- | 50.8(2.00) | 14.2(0.56) | 11.9(0.47) | 27.0(1.06) | 25.9(1.02) |
| 18 | 3/4 | MT18-MA-PMBP12- | 53.2(2.09) | 16.0(0.63) | 14.0(0.55) | 33.0(1.30) | 32.0(1.26) |
| 20 | 3/4 | MT20-MA-PMBP12- | 54.0(2.13) | 16.0(0.63) | 15.1(0.59) | 33.0(1.30) | 32.0(1.26) |
| 25 | 1 | MT25-MA-PMBP16- | 65.1(2.56) | 18.3(0.72) | 19.8(0.78) | 41.0(1.61) | 38.9(1.53) |
| 28 | 1 | MT28-MA-PMBP16- | 72.7(2.86) | 18.3(0.72) | 19.8(0.78) | 41.0(1.61) | 38.9(1.53) |
| 28 | 1 1/4 | MT28-MA-PMBP20- [ⓐ] | 77.3(3.04) | 19.8(0.78) | 22.5(0.89) | 50.0(1.97) | 49.0(1.93) |
| 30 | 1 1/4 | MT30-MA-PMBP20- [ⓐ] | 80.8(3.18) | 19.8(0.78) | 24.3(0.96) | 50.0(1.97) | 49.0(1.93) |
| 32 | 1 1/4 | MT32-MA-PMBP20- [ⓐ] | 82.1(3.23) | 19.8(0.78) | 26.5(1.04) | 50.0(1.97) | 49.0(1.93) |
| 38 | 1 1/2 | MT38-MA-PMBP24- [ⓐ] | 94.5(3.72) | 22.1(0.87) | 31.6(1.24) | 55.0(2.17) | 54.7(2.15) |

ⓐ Оснащен гайкой и предварительно обжатыми кольцами.

Трубный адаптер с внутренней резьбой

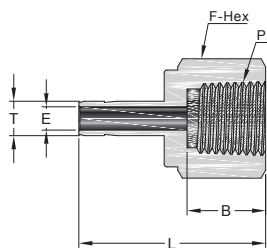

1" и меньше

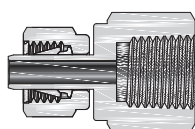

1 1/4" и больше

Дюймовая трубка

Резьба NPT

| Трубка, дюйм | P-NPT резьба | Артикул для заказа | Размеры, дюйм (мм) | | | |
|-----------------|-----------------|------------------------------|--------------------|------------|------------|------------|
| | | | L | B | E | F |
| 1/16 | 1/8 | FT1-FA-FNPT2- | 1.07(27.2) | 0.41(10.4) | 0.03(0.8) | 0.56(14.3) |
| 1/8 | 1/8 | FT2-FA-FNPT2- | 1.24(31.5) | 0.41(10.4) | 0.08(2.0) | 0.56(14.3) |
| 1/8 | 1/4 | FT2-FA-FNPT4- | 1.39(35.3) | 0.59(15.0) | 0.08(2.0) | 0.75(19.1) |
| 3/16 | 1/8 | FT3-FA-FNPT2- | 1.25(31.8) | 0.41(10.4) | 0.11(2.9) | 0.56(14.3) |
| 3/16 | 1/4 | FT3-FA-FNPT4- | 1.41(35.8) | 0.59(15.0) | 0.12(3.0) | 0.75(19.1) |
| 1/4 | 1/8 | FT4-FA-FNPT2- | 1.30(33.0) | 0.41(10.4) | 0.17(4.3) | 0.56(14.3) |
| 1/4 | 1/4 | FT4-FA-FNPT4- | 1.46(37.1) | 0.59(15.0) | 0.17(4.3) | 0.75(19.1) |
| 1/4 | 3/8 | FT4-FA-FNPT6- | 1.55(39.4) | 0.59(15.0) | 0.17(4.3) | 0.87(22.2) |
| 1/4 | 1/2 | FT4-FA-FNPT8- | 1.79(45.5) | 0.78(19.8) | 0.17(4.3) | 1.06(27.0) |
| 5/16 | 1/8 | FT5-FA-FNPT2- | 1.34(34.0) | 0.41(10.4) | 0.22(5.6) | 0.56(14.3) |
| 5/16 | 1/4 | FT5-FA-FNPT4- | 1.48(37.6) | 0.59(15.0) | 0.22(5.6) | 0.75(19.1) |
| 5/16 | 3/8 | FT5-FA-FNPT6- | 1.59(40.4) | 0.59(15.0) | 0.22(5.6) | 0.87(22.2) |
| 3/8 | 1/8 | FT6-FA-FNPT2- | 1.35(34.3) | 0.41(10.4) | 0.27(6.9) | 0.56(14.3) |
| 3/8 | 1/4 | FT6-FA-FNPT4- | 1.50(38.1) | 0.59(15.0) | 0.27(6.9) | 0.75(19.1) |
| 3/8 | 3/8 | FT6-FA-FNPT6- | 1.59(40.4) | 0.59(15.0) | 0.27(6.9) | 0.87(22.2) |
| 3/8 | 1/2 | FT6-FA-FNPT8- | 1.84(46.7) | 0.78(19.8) | 0.27(6.9) | 1.06(27.0) |
| 1/2 | 1/4 | FT8-FA-FNPT4- | 1.71(43.4) | 0.59(15.0) | 0.37(9.4) | 0.75(19.1) |
| 1/2 | 3/8 | FT8-FA-FNPT6- | 1.79(45.5) | 0.59(15.0) | 0.37(9.4) | 0.87(22.2) |
| 1/2 | 1/2 | FT8-FA-FNPT8- | 2.04(51.8) | 0.78(19.8) | 0.37(9.4) | 1.06(27.0) |
| 5/8 | 3/8 | FT10-FA-FNPT6- | 1.86(47.2) | 0.59(15.0) | 0.47(11.9) | 0.87(22.2) |
| 5/8 | 1/2 | FT10-FA-FNPT8- | 2.09(53.1) | 0.78(19.8) | 0.47(11.9) | 1.06(27.0) |
| 3/4 | 1/2 | FT12-FA-FNPT8- | 2.08(52.8) | 0.78(19.8) | 0.58(14.7) | 1.06(27.0) |
| 3/4 | 3/4 | FT12-FA-FNPT12- | 2.16(54.9) | 0.81(20.6) | 0.58(14.7) | 1.31(33.3) |
| 3/4 | 1 | FT12-FA-FNPT16- | 2.30(58.4) | 1.00(25.4) | 0.58(14.7) | 1.63(41.3) |
| 7/8 | 3/4 | FT14-FA-FNPT12- | 2.22(56.4) | 0.81(20.6) | 0.58(14.7) | 1.31(33.3) |
| 1 | 3/4 | FT16-FA-FNPT12- | 2.39(60.7) | 0.81(20.6) | 0.80(20.3) | 1.31(33.3) |
| 1 | 1 | FT16-FA-FNPT16- | 2.53(64.3) | 1.00(25.4) | 0.80(20.3) | 1.63(41.3) |
| 1 1/4 | 1 1/4 | FT20-FA-FNPT20- ^⓪ | 3.06(77.7) | 1.00(25.4) | 1.02(25.9) | 2.13(54.0) |
| 1 1/2 | 1 1/2 | FT24-FA-FNPT24- ^⓪ | 3.50(88.9) | 1.09(27.7) | 1.25(31.8) | 2.37(60.3) |

⓪ Оснащен гайкой и предварительно обжатыми кольцами.

Дюймовая трубка

Коническая резьба ISO (RT)

| Трубка, дюйм | P-RT Резьба | Артикул для заказа | Размеры, дюйм (мм) | | | |
|-----------------|----------------|-----------------------|--------------------|------------|-----------|------------|
| | | | L | B | E | F |
| 1/4 | 1/8 | FT4-FA-FBT2- | 1.30(33.0) | 0.41(10.4) | 0.17(4.3) | 0.56(14.3) |
| 1/4 | 1/4 | FT4-FA-FBT4- | 1.45(36.8) | 0.59(15.0) | 0.17(4.3) | 0.75(19.1) |
| 3/8 | 1/4 | FT6-FA-FBT4- | 1.50(38.1) | 0.59(15.0) | 0.27(6.9) | 0.75(19.1) |
| 3/8 | 3/8 | FT6-FA-FBT6- | 1.59(40.4) | 0.59(15.0) | 0.27(6.9) | 0.87(22.2) |
| 1/2 | 1/4 | FT8-FA-FBT4- | 1.71(43.4) | 0.59(15.0) | 0.37(9.4) | 0.75(19.1) |
| 1/2 | 3/8 | FT8-FA-FBT6- | 1.80(45.7) | 0.59(15.0) | 0.37(9.4) | 0.87(22.2) |
| 1/2 | 1/2 | FT8-FA-FBT8- | 2.05(52.1) | 0.78(19.8) | 0.37(9.4) | 1.06(27.0) |

Трубный адаптер с внутренней резьбой

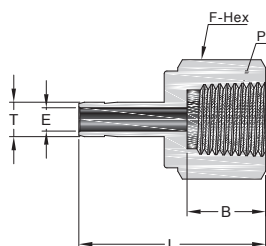

Метрическая трубка

Резьба NPT

| Трубка, мм | P-NPT резьба | Артикул для заказа | Размеры, дюйм (мм) | | | |
|------------|--------------|--------------------|--------------------|------------|------------|------------|
| | | | L | B | E | F |
| 3 | 1/8 | MT3-FA-FNPT2- | 28.8(1.13) | 10.4(0.41) | 1.3(0.05) | 14.0(0.55) |
| 4 | 1/8 | MT4-FA-FNPT2- | 33.3(1.31) | 10.4(0.41) | 2.0(0.08) | 14.0(0.55) |
| 6 | 1/8 | MT6-FA-FNPT2- | 32.5(1.28) | 10.4(0.41) | 4.1(0.16) | 14.0(0.55) |
| 6 | 1/4 | MT6-FA-FNPT4- | 37.1(1.46) | 15.0(0.59) | 4.1(0.16) | 19.0(0.75) |
| 8 | 1/8 | MT8-FA-FNPT2- | 35.1(1.38) | 10.4(0.41) | 6.4(0.25) | 14.0(0.55) |
| 8 | 1/4 | MT8-FA-FNPT4- | 37.6(1.48) | 15.0(0.59) | 5.6(0.22) | 19.0(0.75) |
| 8 | 3/8 | MT8-FA-FNPT6- | 36.5(1.44) | 15.0(0.59) | 6.4(0.25) | 22.0(0.87) |
| 10 | 1/4 | MT10-FA-FNPT4- | 38.1(1.50) | 15.0(0.59) | 7.1(0.28) | 19.0(0.75) |
| 10 | 3/8 | MT10-FA-FNPT6- | 40.1(1.58) | 15.0(0.59) | 7.1(0.28) | 22.0(0.87) |
| 10 | 1/2 | MT10-FA-FNPT8- | 46.5(1.83) | 19.8(0.78) | 7.1(0.28) | 27.0(1.06) |
| 12 | 1/4 | MT12-FA-FNPT4- | 43.7(1.72) | 15.0(0.59) | 8.8(0.35) | 19.0(0.75) |
| 12 | 3/8 | MT12-FA-FNPT6- | 42.9(1.69) | 15.0(0.59) | 9.1(0.36) | 22.0(0.87) |
| 12 | 1/2 | MT12-FA-FNPT8- | 52.3(2.06) | 19.8(0.78) | 8.8(0.35) | 27.0(1.06) |
| 16 | 1/2 | MT16-FA-FNPT8- | 49.2(1.94) | 19.8(0.78) | 12.7(0.50) | 27.0(1.06) |
| 18 | 3/4 | MT18-FA-FNPT12- | 52.4(2.06) | 20.6(0.81) | 14.0(0.55) | 32.0(1.26) |
| 20 | 1/2 | MT20-FA-FNPT8- | 50.0(1.97) | 19.8(0.78) | 15.0(0.59) | 27.0(1.06) |
| 20 | 3/4 | MT20-FA-FNPT12- | 53.2(2.09) | 20.6(0.81) | 15.1(0.59) | 32.0(1.26) |
| 25 | 1 | MT25-FA-FNPT16- | 66.7(2.63) | 25.4(1.00) | 19.8(0.78) | 41.0(1.61) |

Метрическая трубка

Коническая резьба ISO (BSPT)

| Трубка, мм | P-BSPT Резьба | Артикул для заказа | Размеры, дюйм (мм) | | | |
|------------|---------------|--------------------|--------------------|------------|------------|------------|
| | | | L | B | E | F |
| 3 | 1/8 | MT3-FA-FBT2- | 27.8(1.09) | 10.4(0.41) | 1.8(0.07) | 14.0(0.55) |
| 4 | 1/8 | MT4-FA-FBT2- | 28.6(1.13) | 10.4(0.41) | 2.0(0.08) | 14.0(0.55) |
| 6 | 1/8 | MT6-FA-FBT2- | 33.0(1.30) | 10.4(0.41) | 4.1(0.16) | 14.0(0.55) |
| 8 | 1/4 | MT8-FA-FBT4- | 37.6(1.48) | 15.0(0.59) | 5.6(0.22) | 19.0(0.75) |
| 10 | 1/4 | MT10-FA-FBT4- | 38.1(1.50) | 15.0(0.59) | 7.1(0.28) | 19.0(0.75) |
| 10 | 3/8 | MT10-FA-FBT6- | 36.5(1.44) | 15.0(0.59) | 7.5(0.30) | 22.0(0.87) |
| 10 | 1/2 | MT10-FA-FBT8- | 41.3(1.63) | 19.8(0.78) | 7.5(0.30) | 27.0(1.06) |
| 12 | 1/4 | MT12-FA-FBT4- | 40.5(1.59) | 15.0(0.59) | 9.1(0.36) | 19.0(0.75) |
| 12 | 3/8 | MT12-FA-FBT6- | 43.7(1.72) | 15.0(0.59) | 9.1(0.36) | 22.0(0.87) |
| 12 | 1/2 | MT12-FA-FBT8- | 46.8(1.84) | 19.8(0.78) | 9.1(0.36) | 27.0(1.06) |
| 16 | 1/2 | MT16-FA-FBT8- | 48.4(1.91) | 19.8(0.78) | 12.7(0.50) | 27.0(1.06) |
| 18 | 3/4 | MT18-FA-FBT12- | 52.4(2.06) | 20.6(0.81) | 14.0(0.55) | 32.0(1.26) |
| 20 | 3/4 | MT20-FA-FBT12- | 53.2(2.09) | 20.6(0.81) | 15.1(0.59) | 32.0(1.26) |
| 25 | 1 | MT25-FA-FBT16- | 66.7(2.63) | 25.4(1.00) | 19.8(0.78) | 41.0(1.61) |

Трубный адаптер с внутренней резьбой

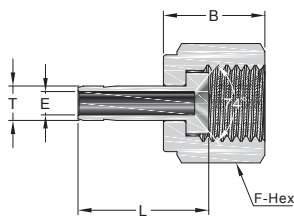
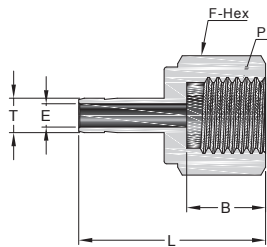

Трубный адаптер с внутренней резьбой

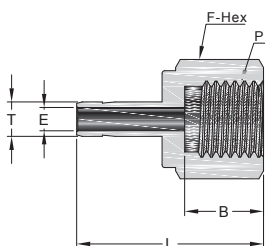
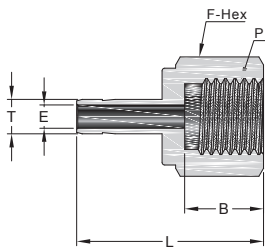

Дюймовая трубка

Цилиндрическая резьба ISO (BP)

| Трубка, дюйм | P-BP Резьба | Артикул для заказа | Размеры, дюйм (мм) | | | |
|--------------|-------------|--------------------|--------------------|------------|-----------|------------|
| | | | L | B | E | F |
| 1/8 | 1/8 | FT2-FA-FBP2- | 1.17(29.7) | 0.40(10.2) | 0.08(2.0) | 0.56(14.3) |
| 1/4 | 1/8 | FT4-FA-FBP2- | 1.25(31.8) | 0.40(10.2) | 0.17(4.3) | 0.56(14.3) |
| 1/4 | 1/4 | FT4-FA-FBP4- | 1.50(38.1) | 0.60(15.2) | 0.17(4.3) | 0.75(19.1) |
| 3/8 | 1/4 | FT6-FA-FBP4- | 1.55(39.4) | 0.60(15.2) | 0.27(6.9) | 0.75(19.1) |
| 3/8 | 3/8 | FT6-FA-FBP6- | 1.57(39.9) | 0.60(15.2) | 0.27(6.9) | 0.94(23.8) |
| 1/2 | 3/8 | FT8-FA-FBP6- | 1.78(45.2) | 0.60(15.2) | 0.38(9.7) | 0.94(23.8) |
| 1/2 | 1/2 | FT8-FA-FBP8- | 1.95(49.5) | 0.72(18.2) | 0.38(9.7) | 1.06(27.0) |

Дюймовая трубка

Резьба AN

| Трубка, дюйм | Размер раструба трубки AN (дюймы) | Артикул для заказа | Размеры, дюйм (мм) | | | |
|--------------|-----------------------------------|--------------------|--------------------|------------|------------|------------|
| | | | L | B | E | F |
| 1/8 | 1/8 | FT2-FA-SAN2- | 0.88(22.4) | 0.55(14.0) | 0.09(2.4) | 0.37(9.5) |
| 1/8 | 1/4 | FT2-FA-SAN4- | 0.88(22.4) | 0.62(15.8) | 0.09(2.4) | 0.56(14.3) |
| 1/4 | 1/4 | FT4-FA-SAN4- | 0.96(24.4) | 0.62(15.8) | 0.18(4.6) | 0.56(14.3) |
| 3/8 | 3/8 | FT6-FA-SAN6- | 1.11(28.1) | 0.73(18.5) | 0.28(7.1) | 0.69(17.5) |
| 1/2 | 1/2 | FT8-FA-SAN8- | 1.42(36.1) | 0.85(21.6) | 0.39(9.9) | 0.87(22.2) |
| 3/4 | 3/4 | FT12-FA-SAN12- | 1.49(37.8) | 1.03(26.2) | 0.58(14.7) | 1.25(31.8) |

Метрическая трубка

Цилиндрическая резьба ISO (BG)

| Трубка, мм | P-BG Резьба | Артикул для заказа | Размеры, дюйм (мм) | | | |
|------------|-------------|--------------------|--------------------|------------|-----------|------------|
| | | | L | B | E | F |
| 3 | 1/8 | MT3-FA-FBP2- | 28.6(1.13) | 6.5(0.26) | 1.6(0.06) | 14.0(0.55) |
| 3 | 1/4 | MT3-FA-FBP4- | 33.5(1.32) | 10.2(0.40) | 1.9(0.07) | 19.0(0.75) |
| 4 | 1/8 | MT4-FA-FBP2- | 29.4(1.16) | 6.5(0.26) | 2.0(0.08) | 14.0(0.55) |
| 6 | 1/8 | MT6-FA-FBP2- | 31.0(1.22) | 6.5(0.26) | 4.1(0.16) | 14.0(0.55) |
| 6 | 1/4 | MT6-FA-FBP4- | 35.3(1.39) | 10.2(0.40) | 4.1(0.16) | 19.0(0.75) |
| 6 | 3/8 | MT6-FA-FBP6- | 38.4(1.51) | 14.2(0.56) | 4.1(0.16) | 24.0(0.94) |
| 6 | 1/2 | MT6-FA-FBP8- | 42.9(1.69) | 18.0(0.71) | 4.1(0.16) | 27.0(1.06) |
| 8 | 1/4 | MT8-FA-FBP4- | 33.0(1.30) | 10.2(0.40) | 5.5(0.22) | 19.0(0.75) |
| 8 | 3/8 | MT8-FA-FBP6- | 38.9(1.53) | 14.2(0.56) | 5.6(0.22) | 24.0(0.94) |
| 8 | 1/2 | MT8-FA-FBP8- | 43.7(1.72) | 18.0(0.71) | 5.6(0.22) | 27.0(1.06) |
| 10 | 1/4 | MT10-FA-FBP4- | 34.5(1.36) | 10.2(0.40) | 5.5(0.22) | 19.0(0.75) |
| 10 | 3/8 | MT10-FA-FBP6- | 36.1(1.42) | 14.2(0.56) | 6.5(0.26) | 24.0(0.94) |
| 10 | 1/2 | MT10-FA-FBP8- | 41.1(1.62) | 18.0(0.71) | 7.1(0.28) | 27.0(1.06) |
| 12 | 1/4 | MT12-FA-FBP4- | 41.1(1.62) | 10.2(0.40) | 5.5(0.22) | 19.0(0.75) |
| 12 | 3/8 | MT12-FA-FBP6- | 44.7(1.76) | 14.2(0.56) | 6.5(0.26) | 24.0(0.94) |
| 12 | 1/2 | MT12-FA-FBP8- | 48.8(1.92) | 18.0(0.71) | 7.0(0.28) | 27.0(1.06) |
| 16 | 1/2 | MT16-FA-FBP8- | 49.0(1.93) | 18.0(0.71) | 7.0(0.28) | 27.0(1.06) |
| 18 | 1/2 | MT18-FA-FBP8- | 49.3(1.94) | 18.0(0.71) | 7.0(0.28) | 27.0(1.06) |

Метрическая трубка

Цилиндрическая резьба ISO (BG)

| Трубка, мм | P-BG Резьба | Артикул для заказа | Размеры, дюйм (мм) | | | |
|------------|-------------|--------------------|--------------------|------------|-----------|------------|
| | | | L | B | E | F |
| 6 | 1/8 | MT6-FA-FBP2- | 32.0(1.26) | 10.2(0.40) | 4.1(0.16) | 14.0(0.55) |
| 6 | 1/4 | MT6-FA-FBP4- | 37.8(1.49) | 15.2(0.60) | 4.1(0.16) | 19.0(0.75) |
| 12 | 1/2 | MT12-FA-FBP8- | 49.8(1.96) | 18.8(0.74) | 8.8(0.35) | 27.0(1.06) |

Фланцевый переходник

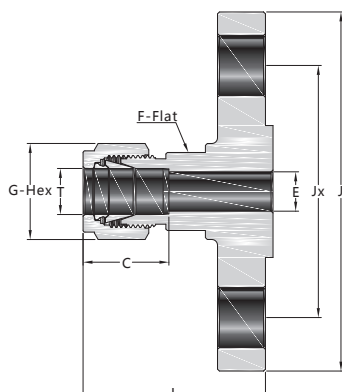

Фланцы по стандарту ASME

| Трубка, мм | Размер фланца | Класс | Артикул для заказа | Размеры, дюйм (мм) | | | | | | |
|------------|---------------|-------|--------------------|--------------------|-------|------|------|------|------|------|
| | | | | L | J | Jx | E | C | G | F |
| 1/4 | 1/2 | 150 | F4-FLA-RF8150- | 40.9 | 88.9 | 60.5 | 4.8 | 15.2 | 14.3 | 20.6 |
| 3/8 | 1/2 | 300 | F6-FLA-RF8150- | 45.5 | 95.3 | 66.5 | 7.1 | 16.8 | 17.5 | 20.6 |
| 1/2 | 1/2 | 150 | F8-FLA-RF8150- | 45.2 | 88.9 | 60.5 | 10.4 | 22.9 | 22.2 | 20.6 |
| 1/2 | 1 | 150 | F8-FLA-RF16150- | 48.3 | 108.0 | 79.2 | 10.4 | 22.9 | 22.2 | 20.6 |
| 1/2 | 2 | 150 | F8-FLA-RF32150- | 53.1 | 152.4 | 121 | 10.4 | 22.9 | 22.2 | 20.6 |
| 3/4 | 1 | 150 | F12-FLA-RF16150- | 50.3 | 108.0 | 79.2 | 15.7 | 24.4 | 28.6 | 31.8 |
| 1 | 1 | 150 | F16-FLA-RF16150- | 60.5 | 108.0 | 79.2 | 22.4 | 31.2 | 38.1 | 34.9 |

Фланцы по стандарту DIN/GB, класс PN 40

| Трубка, мм | Размер фланца | Артикул для заказа | Размеры, дюйм (мм) | | | | | | |
|------------|---------------|--------------------|--------------------|-------------|-------------|------------|------------|------------|------------|
| | | | L | J | Jx | E | C | G | F |
| 6 | 25 | M6-FLA-RF2540B1- | 47.5(1.87) | 115.0(4.53) | 85.0(3.35) | 4.8(0.19) | 15.3(0.60) | 14.0(0.55) | 20.0(0.79) |
| 12 | 15 | M12-FLA-RF1540B1- | 48.5(1.91) | 95.0(3.74) | 65.0(2.56) | 9.5(0.37) | 22.8(0.90) | 22.0(0.87) | 20.0(0.79) |
| 12 | 25 | M12-FLA-RF2540B1- | 50.5(1.99) | 115.0(4.53) | 85.0(3.35) | 9.5(0.37) | 22.8(0.90) | 22.0(0.87) | 20.0(0.79) |
| 12 | 50 | M12-FLA-RF5040B1- | 55.3(2.18) | 165.0(6.50) | 125.0(4.92) | 9.5(0.37) | 22.8(0.90) | 22.0(0.87) | 20.0(0.79) |
| 18 | 15 | M18-FLA-RF1540B1- | 51.8(2.04) | 95.0(3.74) | 65.0(2.56) | 15.1(0.59) | 24.4(0.96) | 30.0(1.18) | 32.0(1.26) |
| 18 | 25 | M18-FLA-RF2540B1- | 53.8(2.12) | 115.0(4.53) | 85.0(3.35) | 15.1(0.59) | 24.4(0.96) | 30.0(1.18) | 32.0(1.26) |
| 25 | 25 | M25-FLA-RF2540B1- | 64.0(2.52) | 115.0(4.53) | 85.0(3.35) | 21.8(0.86) | 31.3(1.23) | 38.0(1.50) | 35.0(1.38) |

Фланцы по стандарту EN, класс PN 40

| Трубка, мм | Размер фланца | Артикул для заказа | Размеры, дюйм (мм) | | | | | | |
|------------|---------------|--------------------|--------------------|-------------|-------------|------------|------------|------------|------------|
| | | | L | J | Jx | E | C | G | F |
| 6 | 25 | M6-FLA-RF25E40B1- | 47.5(1.87) | 115.0(4.53) | 85.0(3.35) | 4.8(0.19) | 15.3(0.60) | 14.0(0.55) | 20.0(0.79) |
| 12 | 15 | M12-FLA-RF15E40B1- | 48.5(1.91) | 95.0(3.74) | 65.0(2.56) | 9.5(0.37) | 22.8(0.90) | 22.0(0.87) | 20.0(0.79) |
| 12 | 25 | M12-FLA-RF25E40B1- | 50.5(1.99) | 115.0(4.53) | 85.0(3.35) | 9.5(0.37) | 22.8(0.90) | 22.0(0.87) | 20.0(0.79) |
| 12 | 50 | M12-FLA-RF50E40B1- | 55.3(2.18) | 165.0(6.50) | 125.0(4.92) | 9.5(0.37) | 22.8(0.90) | 22.0(0.87) | 20.0(0.79) |
| 18 | 15 | M18-FLA-RF15E40B1- | 51.8(2.04) | 95.0(3.74) | 65.0(2.56) | 15.1(0.59) | 24.4(0.96) | 30.0(1.18) | 32.0(1.26) |
| 18 | 25 | M18-FLA-RF25E40B1- | 53.8(2.12) | 115.0(4.53) | 85.0(3.35) | 15.1(0.59) | 24.4(0.96) | 30.0(1.18) | 32.0(1.26) |
| 25 | 25 | M25-FLA-RF25E40B1- | 64.0(2.52) | 115.0(4.53) | 85.0(3.35) | 21.8(0.86) | 31.3(1.23) | 38.0(1.50) | 35.0(1.38) |

Фланцы по стандарту JIS, класс 10K

| Трубка, мм | Размер фланца | Артикул для заказа | Размеры, дюйм (мм) | | | | | | |
|------------|---------------|--------------------|--------------------|-------------|------------|------------|------------|------------|------------|
| | | | L | J | Jx | E | C | G | F |
| 1/4 | 15 | F4-FLA-RF1510K- | 1.66(42.2) | 3.74(95.0) | 2.76(70.1) | 0.19(4.8) | 0.60(15.2) | 0.56(14.3) | 0.81(20.6) |
| 3/8 | 15 | F6-FLA-RF1510K- | 1.72(43.7) | 3.74(95.0) | 2.76(70.1) | 0.28(7.1) | 0.66(16.8) | 0.69(17.5) | 0.81(20.6) |
| 1/2 | 15 | F8-FLA-RF1510K- | 1.83(46.5) | 3.74(95.0) | 2.76(70.1) | 0.41(10.4) | 0.90(22.9) | 0.87(22.2) | 0.81(20.6) |
| 3/4 | 15 | F12-FLA-RF1510K- | 1.91(48.5) | 3.74(95.0) | 2.76(70.1) | 0.62(15.7) | 0.96(24.4) | 1.13(28.6) | 1.25(31.8) |
| 1 | 25 | F16-FLA-RF2510K- | 2.40(61.0) | 4.92(125.0) | 3.54(89.9) | 0.88(22.4) | 1.23(31.2) | 1.50(38.1) | 1.37(34.9) |
| 12mm | 15 | M12-FLA-RF1510K- | 1.83(46.5) | 3.74(95.0) | 2.76(70.0) | 0.37(9.5) | 0.90(22.8) | 0.87(22.0) | 0.79(20.0) |
| 18mm | 15 | M18-FLA-RF1510K- | 1.91(48.5) | 3.74(95.0) | 2.76(70.0) | 0.59(15.1) | 0.96(24.4) | 1.18(30.0) | 1.26(32.0) |
| 25mm | 25 | M25-FLA-RF2510K- | 2.40(61.0) | 4.92(125.0) | 3.54(90.0) | 0.86(21.8) | 1.23(31.3) | 1.50(38.0) | 1.38(35.0) |

Переходник с санитарного фланца

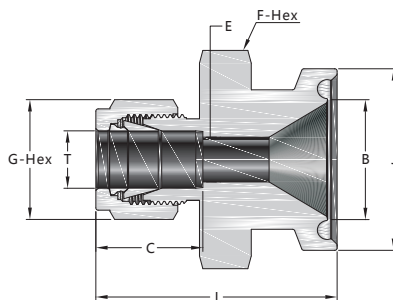

Дюймовая трубка

| Трубка, дюйм | Размер фланца | Артикул для заказа | Размеры, дюйм (мм) | | | | | | |
|--------------|---------------|--------------------|--------------------|------------|------------|------------|------------|------------|------------|
| | | | L | B | C | E | F | J | G |
| 1/4 | 1/2 | F4-SFF-SF8- | 1.57(39.9) | 0.37(9.4) | 0.60(15.2) | 0.19(4.8) | 1.00(25.4) | 0.98(24.9) | 0.98(24.9) |
| 1/4 | 3/4 | F4-SFF-SF12- | 1.57(39.9) | 0.62(15.7) | 0.60(15.2) | 0.19(4.8) | 1.00(25.4) | 0.98(24.9) | 0.98(24.9) |
| 1/4 | 1 | F4-SFF-SF16- | 1.57(39.9) | 0.87(22.1) | 0.60(15.2) | 0.19(4.8) | 1.37(34.9) | 1.98(50.3) | 1.98(50.3) |
| 1/4 | 1 1/2 | F4-SFF-SF24- | 1.57(39.9) | 1.37(34.8) | 0.60(15.2) | 0.19(4.8) | 1.37(34.9) | 1.98(50.3) | 1.98(50.3) |
| 3/8 | 1/2 | F6-SFF-SF8- | 1.63(41.4) | 0.30(7.6) | 0.66(16.8) | 0.28(7.1) | 1.00(25.4) | 0.98(24.9) | 0.98(24.9) |
| 3/8 | 3/4 | F6-SFF-SF12- | 1.63(41.4) | 0.62(15.7) | 0.66(16.8) | 0.28(7.1) | 1.00(25.4) | 0.98(24.9) | 0.98(24.9) |
| 3/8 | 1 | F6-SFF-SF16- | 1.63(41.4) | 0.87(22.1) | 0.66(16.8) | 0.28(7.1) | 1.37(34.9) | 1.98(50.3) | 1.98(50.3) |
| 3/8 | 1 1/2 | F6-SFF-SF24- | 1.63(41.4) | 1.37(34.8) | 0.66(16.8) | 0.28(7.1) | 1.37(34.9) | 1.98(50.3) | 1.98(50.3) |
| 1/2 | 1/2 | F8-SFF-SF8- | 1.74(44.2) | 0.30(7.6) | 0.90(22.9) | 0.37(9.4) | 1.00(25.4) | 0.98(24.9) | 0.98(24.9) |
| 1/2 | 3/4 | F8-SFF-SF12- | 1.74(44.2) | 0.62(15.7) | 0.90(22.9) | 0.41(10.4) | 1.00(25.4) | 0.98(24.9) | 0.98(24.9) |
| 1/2 | 1 | F8-SFF-SF16- | 1.74(44.2) | 0.87(22.1) | 0.90(22.9) | 0.41(10.4) | 1.37(34.9) | 1.98(50.3) | 1.98(50.3) |
| 1/2 | 1 1/2 | F8-SFF-SF24- | 1.74(44.2) | 1.37(34.8) | 0.90(22.9) | 0.41(10.4) | 1.37(34.9) | 1.98(50.3) | 1.98(50.3) |
| 1 | 1 | F16-SFF-SF16- | 1.91(48.5) | 0.87(22.1) | 1.23(31.2) | 0.87(22.1) | 1.37(34.9) | 1.98(50.3) | 1.98(50.3) |
| 1 | 2 | F16-SFF-SF32- | 2.49(63.2) | 1.37(34.8) | 1.23(31.2) | 0.88(22.4) | 2.75(69.9) | 2.52(64.0) | 2.52(64.0) |

Штуцер под приварку

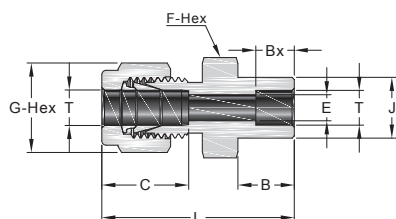

Дюймовая трубка

Под приварку внахлест

| Трубка, дюйм | Артикул для заказа | Размеры, мм | | | | | | | |
|--------------|--------------------|-------------|------|------|------|------|------|------|------|
| | | L | C | G | F | B | E | Bx | J |
| 1/8 | F2-WC-FSW2- | 29.0 | 12.7 | 11.1 | 11.1 | 8.6 | 2.3 | 2.5 | 7.9 |
| 3/16 | F3-WC-FSW3- | 29.7 | 13.7 | 12.7 | 11.1 | 9.5 | 3.3 | 4.8 | 10.7 |
| 1/4 | F4-WC-FSW4- | 33.5 | 15.2 | 14.3 | 12.7 | 10.4 | 4.8 | 7.1 | 11.2 |
| 3/8 | F6-WC-FSW6- | 37.6 | 16.8 | 17.5 | 15.9 | 11.9 | 7.1 | 7.9 | 15.7 |
| 1/2 | F8-WC-FSW8- | 41.1 | 22.9 | 22.2 | 20.6 | 11.9 | 10.4 | 9.7 | 19.1 |
| 5/8 | F10-WC-FSW10- | 41.9 | 24.4 | 25.4 | 23.8 | 11.9 | 12.7 | 10.4 | 23.4 |
| 3/4 | F12-WC-FSW12- | 43.4 | 24.4 | 28.6 | 27.0 | 11.9 | 15.7 | 11.1 | 26.7 |
| 1 | F16-WC-FSW16- | 52.6 | 31.2 | 38.1 | 34.9 | 14.2 | 22.4 | 15.7 | 33.3 |

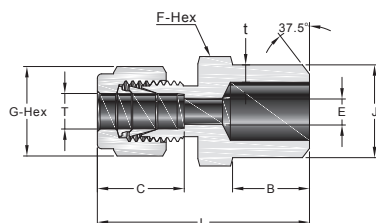

Дюймовая трубка

Под приварку встык

| Трубка, дюйм | Трубка под приварку | Артикул для заказа | Размеры, мм | | | | | | | |
|--------------|---------------------|--------------------|-------------|------|------|------|------|------|------|-----|
| | | | L | C | G | F | E | B | J | t |
| 1/8 | 1/8 | F2-WC-PBW2- | 30.5 | 12.7 | 11.1 | 11.1 | 2.3 | 9.7 | 10.3 | 2.4 |
| 3/16 | 1/8 | F3-WC-PBW2- | 31.2 | 13.7 | 12.7 | 11.1 | 3.0 | 9.7 | 10.3 | 2.4 |
| 1/4 | 1/8 | F4-WC-PBW2- | 32.8 | 15.2 | 14.3 | 12.7 | 4.8 | 9.7 | 10.3 | 2.4 |
| 1/4 | 1/4 | F4-WC-PBW4- | 37.8 | 15.2 | 14.3 | 14.3 | 4.8 | 14.2 | 13.7 | 3.0 |
| 5/16 | 1/8 | F5-WC-PBW2- | 34.0 | 16.3 | 15.9 | 14.3 | 5.3 | 9.7 | 10.3 | 2.4 |
| 5/16 | 1/4 | F5-WC-PBW4- | 38.6 | 16.3 | 15.9 | 14.3 | 6.4 | 14.2 | 13.7 | 3.0 |
| 3/8 | 1/4 | F6-WC-PBW4- | 39.9 | 16.8 | 17.5 | 15.9 | 7.1 | 14.2 | 13.7 | 3.0 |
| 3/8 | 3/8 | F6-WC-PBW6- | 39.9 | 16.8 | 17.5 | 17.5 | 7.1 | 14.2 | 17.1 | 3.2 |
| 3/8 | 1/2 | F6-WC-PBW8- | 46.2 | 16.8 | 17.5 | 22.2 | 7.1 | 19.1 | 21.3 | 3.7 |
| 3/8 | 3/4 | F6-WC-PBW12- | 47.8 | 16.8 | 17.5 | 27.0 | 7.1 | 19.1 | 26.7 | 3.9 |
| 1/2 | 3/8 | F8-WC-PBW6- | 43.4 | 22.9 | 22.2 | 20.6 | 10.4 | 14.2 | 17.1 | 3.2 |
| 1/2 | 1/2 | F8-WC-PBW8- | 49.0 | 22.9 | 22.2 | 22.2 | 10.4 | 19.1 | 21.3 | 3.7 |
| 1/2 | 3/4 | F8-WC-PBW12- | 50.5 | 22.9 | 22.2 | 27.0 | 10.4 | 19.1 | 26.7 | 3.9 |
| 5/8 | 1/2 | F10-WC-PBW8- | 49.0 | 24.4 | 25.4 | 23.8 | 12.7 | 19.1 | 21.3 | 3.7 |
| 3/4 | 1/2 | F12-WC-PBW8- | 50.5 | 24.4 | 28.6 | 27.0 | 14.0 | 19.1 | 21.3 | 3.7 |
| 3/4 | 3/4 | F12-WC-PBW12- | 50.5 | 24.4 | 28.6 | 27.0 | 15.7 | 19.1 | 26.7 | 3.9 |
| 1 | 1 | F16-WC-PBW16- | 62.2 | 31.2 | 38.1 | 34.9 | 22.4 | 23.9 | 33.4 | 4.5 |
| 1 1/4 | 1 1/4 | F20-WC-PBW20- | 77.2 | 41.1 | 47.6 | 44.5 | 27.7 | 23.9 | 42.2 | 4.9 |
| 1 1/2 | 1 1/2 | F24-WC-PBW24- | 88.9 | 50.0 | 57.2 | 54.0 | 34.0 | 26.2 | 48.3 | 5.1 |

Штуцер под приварку

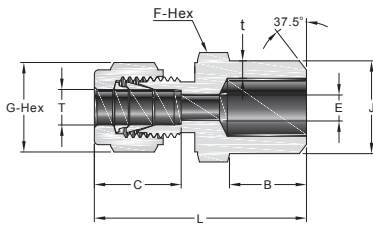

Метрическая трубка

Под приварку встык

| Трубка, мм | Трубка под приварку | Артикул для заказа | Размеры, мм | | | | | | |
|------------|---------------------|--------------------|-------------|------|----|----|------|------|-----|
| | | | L | C | G | F | E | B | t |
| 3 | 1/8 | M3-WC-PBW2- | 30.5 | 12.9 | 12 | 12 | 2.4 | 9.7 | 2.4 |
| 4 | 1/8 | M4-WC-PBW2- | 31.5 | 13.7 | 12 | 12 | 2.4 | 9.7 | 2.4 |
| 6 | 1/8 | M6-WC-PBW2- | 32.8 | 15.3 | 14 | 14 | 4.8 | 9.7 | 2.4 |
| 6 | 1/4 | M6-WC-PBW4- | 37.9 | 15.3 | 14 | 14 | 4.8 | 14.2 | 3.0 |
| 8 | 1/8 | M8-WC-PBW2- | 34.2 | 16.2 | 16 | 15 | 5.4 | 9.7 | 2.4 |
| 8 | 1/4 | M8-WC-PBW4- | 38.7 | 16.2 | 16 | 15 | 6.4 | 14.2 | 3.0 |
| 8 | 1/2 | M8-WC-PBW8- | 45.6 | 16.2 | 16 | 22 | 6.4 | 19.1 | 3.7 |
| 10 | 1/4 | M10-WC-PBW4- | 40.9 | 17.2 | 19 | 18 | 7.5 | 14.2 | 3.0 |
| 10 | 3/8 | M10-WC-PBW6- | 40.9 | 17.2 | 19 | 18 | 7.9 | 14.2 | 3.2 |
| 10 | 1/2 | M10-WC-PBW8- | 46.5 | 17.2 | 19 | 22 | 7.9 | 19.1 | 3.7 |
| 12 | 1/4 | M12-WC-PBW4- | 43.4 | 22.8 | 22 | 22 | 7.5 | 14.2 | 3.0 |
| 12 | 3/8 | M12-WC-PBW6- | 43.4 | 22.8 | 22 | 22 | 9.5 | 14.2 | 3.2 |
| 12 | 1/2 | M12-WC-PBW8- | 49.0 | 22.8 | 22 | 22 | 9.5 | 19.1 | 3.7 |
| 14 | 3/8 | M14-WC-PBW6- | 44.1 | 24.4 | 25 | 24 | 10.7 | 14.2 | 3.2 |
| 15 | 1/2 | M15-WC-PBW8- | 49.0 | 24.4 | 25 | 24 | 11.9 | 19.1 | 3.7 |
| 16 | 1/2 | M16-WC-PBW8- | 49.0 | 24.4 | 25 | 24 | 12.7 | 19.1 | 3.7 |
| 18 | 1/2 | M18-WC-PBW8- | 50.5 | 24.4 | 30 | 27 | 13.9 | 19.1 | 3.7 |
| 30 | 1 1/4 | M30-WC-PBW20- | 77.2 | 39.6 | 50 | 46 | 26.2 | 23.9 | 4.9 |
| 32 | 1 1/4 | M32-WC-PBW20- | 79.6 | 42.0 | 50 | 46 | 28.6 | 23.9 | 4.9 |
| 38 | 1 1/2 | M38-WC-PBW24- | 91.6 | 49.4 | 60 | 55 | 33.7 | 26.2 | 5.1 |

Соединительный угольник под приварку

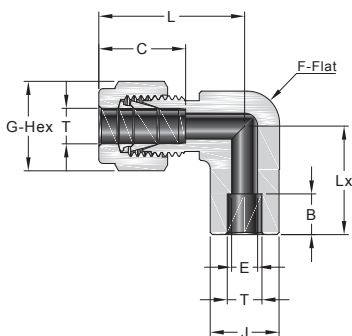

Дюймовая трубка

Под приварку враструб

| Трубка, дюйм | Артикул для заказа | Размеры, мм | | | | | | | |
|--------------|--------------------|-------------|------|------|------|------|------|------|------|
| | | L | C | G | F | B | E | Lx | J |
| 1/8 | F2-WE-FSW2- | 16.8 | 12.7 | 11.1 | 9.5 | 2.5 | 2.3 | 16.0 | 9.7 |
| 3/16 | F3-WE-FSW3- | 18.3 | 13.7 | 12.7 | 11.1 | 4.8 | 3.3 | 17.5 | 11.2 |
| 1/4 | F4-WE-FSW4- | 26.9 | 15.2 | 14.3 | 12.7 | 7.1 | 4.8 | 19.6 | 12.7 |
| 3/8 | F6-WE-FSW6- | 30.5 | 16.8 | 17.5 | 15.9 | 7.9 | 7.1 | 23.1 | 15.7 |
| 1/2 | F8-WE-FSW8- | 36.1 | 22.9 | 22.2 | 20.6 | 9.7 | 10.4 | 25.9 | 20.6 |
| 5/8 | F10-WE-FSW10- | 29.5 | 24.4 | 25.4 | 27.0 | 10.4 | 12.7 | 29.5 | 23.9 |
| 3/4 | F12-WE-FSW12- | 39.9 | 24.4 | 28.6 | 27.0 | 11.2 | 15.7 | 29.7 | 26.9 |
| 1 | F16-WE-FSW16- | 49.0 | 31.2 | 38.1 | 34.9 | 15.7 | 22.4 | 36.8 | 35.1 |

Соединительный угольник под приварку

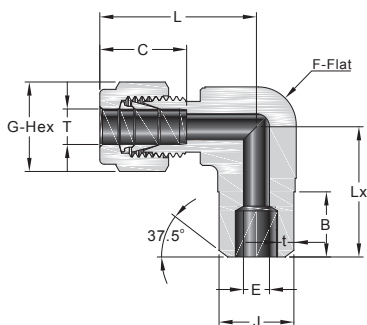

Дюймовая трубка

Под приварку встык

| Трубка, дюйм | Трубка под приварку | Артикул для заказа | Размеры, мм | | | | | | | |
|--------------|---------------------|--------------------|-------------|------|------|------|------|------|------|------|
| | | | L | C | G | F | B | E | Lx | J |
| 1/8 | 1/8 | F2-WE-PBW2- | 23.4 | 12.7 | 11.1 | 11.1 | 9.7 | 2.3 | 18.3 | 10.3 |
| 3/16 | 1/8 | F3-WE-PBW2- | 25.7 | 13.7 | 12.7 | 12.7 | 9.7 | 3.3 | 18.8 | 10.3 |
| 1/4 | 1/8 | F4-WE-PBW2- | 26.9 | 15.2 | 14.3 | 12.7 | 9.7 | 4.8 | 18.8 | 10.3 |
| 1/4 | 1/4 | F4-WE-PBW4- | 26.9 | 15.2 | 14.3 | 12.7 | 14.2 | 4.8 | 23.4 | 13.7 |
| 3/8 | 1/4 | F6-WE-PBW4- | 30.5 | 16.8 | 17.5 | 15.9 | 14.2 | 7.1 | 25.4 | 13.7 |
| 1/2 | 3/8 | F8-WE-PBW6- | 34.8 | 22.9 | 22.2 | 19.1 | 14.2 | 10.4 | 28.8 | 17.2 |
| 1/2 | 1/2 | F8-WE-PBW8- | 36.1 | 22.9 | 22.2 | 20.6 | 19.1 | 10.4 | 33.0 | 21.3 |
| 5/8 | 1/2 | F10-WE-PBW8- | 36.3 | 24.4 | 25.4 | 23.8 | 19.1 | 12.7 | 35.1 | 21.3 |
| 3/4 | 3/4 | F12-WE-PBW12- | 39.9 | 24.4 | 28.6 | 27.0 | 19.1 | 15.7 | 36.8 | 26.7 |
| 1 | 3/4 | F16-WE-PBW12- | 49.3 | 31.2 | 38.1 | 34.9 | 19.1 | 22.4 | 41.9 | 26.7 |
| 1 | 1 | F16-WE-PBW16- | 49.3 | 31.2 | 38.1 | 34.9 | 20.6 | 22.4 | 46.7 | 33.4 |

Гайка

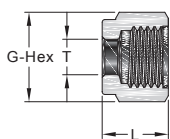

Дюймовая трубка

| Трубка, дюйм | Артикул для заказа | Размеры, дюйм (мм) | |
|--------------|--------------------|--------------------|------------|
| | | L | G |
| 1/16 | N-F1- | 0.31(7.9) | 0.31(7.9) |
| 1/8 | N-F2- | 0.47(11.9) | 0.44(11.1) |
| 3/16 | N-F3- | 0.47(11.9) | 0.50(12.7) |
| 1/4 | N-F4- | 0.50(12.7) | 0.56(14.3) |
| 5/16 | N-F5- | 0.53(13.5) | 0.63(15.9) |
| 3/8 | N-F6- | 0.56(14.2) | 0.69(17.5) |
| 1/2 | N-F8- | 0.69(17.5) | 0.87(22.2) |
| 5/8 | N-F10- | 0.69(17.5) | 1.00(25.4) |
| 3/4 | N-F12- | 0.69(17.5) | 1.13(28.6) |
| 7/8 | N-F14- | 0.69(17.5) | 1.25(31.8) |
| 1 | N-F16- | 0.81(20.6) | 1.50(38.1) |
| 1 1/8 | N-F18- | 1.21(30.8) | 1.81(46.0) |
| 1 1/4 | N-F20- | 1.25(31.8) | 1.87(47.6) |
| 1 1/2 | N-F24- | 1.50(38.1) | 2.25(57.2) |

Метрическая трубка

| Трубка, мм | Артикул для заказа | Размеры, дюйм (мм) | |
|------------|--------------------|--------------------|------------|
| | | L | G |
| 2 | N-M2- | 11.9(0.47) | 12.0(0.47) |
| 3 | N-M3- | 11.9(0.47) | 12.0(0.47) |
| 4 | N-M4- | 11.9(0.47) | 12.0(0.47) |
| 6 | N-M6- | 12.7(0.50) | 14.0(0.55) |
| 8 | N-M8- | 13.5(0.53) | 16.0(0.63) |
| 10 | N-M10- | 15.1(0.59) | 19.0(0.75) |
| 12 | N-M12- | 17.4(0.69) | 22.0(0.87) |
| 14 | N-M14- | 17.4(0.69) | 25.0(0.98) |
| 15 | N-M15- | 17.4(0.69) | 25.0(0.98) |
| 16 | N-M16- | 17.4(0.69) | 25.0(0.98) |
| 18 | N-M18- | 17.4(0.69) | 30.0(1.18) |
| 20 | N-M20- | 17.4(0.69) | 32.0(1.26) |
| 22 | N-M22- | 17.4(0.69) | 32.0(1.26) |
| 25 | N-M25- | 20.6(0.81) | 38.0(1.50) |
| 28 | N-M28- | 30.6(1.20) | 46.0(1.81) |
| 30 | N-M30- | 32.7(1.29) | 50.0(1.97) |
| 32 | N-M32- | 34.4(1.35) | 50.0(1.97) |
| 38 | N-M38- | 40.6(1.60) | 60.0(2.36) |

Гайки

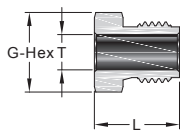

Дюймовая трубка

| Трубка, дюйм | Артикул для заказа | Размеры, дюйм (мм) | |
|--------------|--------------------|--------------------|------------|
| | | L | G |
| 1/16 | MN-F1- | 0.38(9.7) | 0.25(6.4) |
| 1/8 | MN-F2- | 0.53(13.5) | 0.37(9.5) |
| 1/4 | MN-F4- | 0.62(15.7) | 0.50(12.7) |
| 1/2 | MN-F8- | 0.87(22.1) | 0.94(23.8) |

Метрическая трубка

| Трубка, мм | Артикул для заказа | Размеры, дюйм (мм) | |
|------------|--------------------|--------------------|------------|
| | | L | G |
| 3 | MN-M3- | 13.5(0.53) | 10.0(0.39) |
| 6 | MN-M6- | 15.7(0.62) | 14.0(0.55) |
| 10 | MN-M10- | 22.1(0.87) | 22.0(0.87) |
| 12 | MN-M12- | 22.1(0.87) | 24.0(0.94) |

Передние обжимные кольца



Дюймовая трубка

| Трубка, дюйм | Артикул для заказа |
|--------------|--------------------|
| 1/16 | FF-F1 |
| 1/8 | FF-F2 |
| 3/16 | FF-F3 |
| 1/4 | FF-F4 |
| 5/16 | FF-F5 |
| 3/8 | FF-F6 |
| 1/2 | FF-F8 |
| 5/8 | FF-F10 |
| 3/4 | FF-F12 |
| 7/8 | FF-F14 |
| 1 | FF-F16 |
| 1 1/8 | FF-F18 |
| 1 1/4 | FF-F20 |
| 1 1/2 | FF-F24 |

Метрическая трубка

| Трубка, мм | Артикул для заказа |
|------------|--------------------|
| 2 | FF-M2 |
| 3 | FF-M3 |
| 4 | FF-M4 |
| 6 | FF-M6 |
| 8 | FF-M8 |
| 10 | FF-M10 |
| 12 | FF-M12 |
| 14 | FF-M14 |
| 15 | FF-M15 |
| 16 | FF-M16 |
| 18 | FF-M18 |
| 20 | FF-M20 |
| 22 | FF-M22 |
| 25 | FF-M25 |
| 28 | FF-M28 |
| 30 | FF-M30 |
| 32 | FF-M32 |
| 38 | FF-M38 |

Задние обжимные кольца



Дюймовая трубка

| Трубка, дюйм | Артикул для заказа |
|--------------|--------------------|
| 1/16 | RF-F1 |
| 1/8 | RF-F2 |
| 3/16 | RF-F3 |
| 1/4 | RF-L4 |
| 5/16 | RF-F5 |
| 3/8 | RF-L6 |
| 1/2 | RF-F8 |
| 5/8 | RF-F10 |
| 3/4 | RF-F12 |
| 7/8 | RF-F14 |
| 1 | RF-F16 |
| 1 1/8 | RF-F18 |
| 1 1/4 | RF-F20 |
| 1 1/2 | RF-F24 |

Метрическая трубка

| Трубка, мм | Артикул для заказа |
|------------|--------------------|
| 2 | RF-M2 |
| 3 | RF-M3 |
| 4 | RF-M4 |
| 6 | RF-M6 |
| 8 | RF-M8 |
| 10 | RF-M10 |
| 12 | RF-M12 |
| 14 | RF-M14 |
| 15 | RF-M15 |
| 16 | RF-M16 |
| 18 | RF-M18 |
| 20 | RF-M20 |
| 22 | RF-M22 |
| 25 | RF-M25 |
| 28 | RF-M28 |
| 30 | RF-M30 |
| 32 | RF-M32 |
| 38 | RF-M38 |

Комплект обжимных колец и гайки

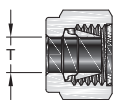

Дюймовая трубка

| Трубка, дюйм | Артикул для заказа |
|--------------|--------------------|
| 1/16 | NFR-F1 |
| 1/8 | NFR-F2 |
| 3/16 | NFR-F3 |
| 1/4 | NFR-F4 |
| 5/16 | NFR-F5 |
| 3/8 | NFR-F6 |
| 1/2 | NFR-F8 |
| 5/8 | NFR-F10 |
| 3/4 | NFR-F12 |
| 7/8 | NFR-F14 |
| 1 | NFR-F16 |
| 1 1/8 | NFR-F18 |
| 1 1/4 | NFR-F20 |
| 1 1/2 | NFR-F24 |

Метрическая трубка

| Трубка, мм | Артикул для заказа |
|------------|--------------------|
| 2 | NFR-M2 |
| 3 | NFR-M3 |
| 4 | NFR-M4 |
| 6 | NFR-M6 |
| 8 | NFR-M8 |
| 10 | NFR-M10 |
| 12 | NFR-M12 |
| 14 | NFR-M14 |
| 15 | NFR-M15 |
| 16 | NFR-M16 |
| 18 | NFR-M18 |
| 20 | NFR-M20 |
| 22 | NFR-M22 |
| 25 | NFR-M25 |
| 28 | NFR-M28 |
| 30 | NFR-M30 |
| 32 | NFR-M32 |
| 38 | NFR-M38 |

Комплект обжимных колец и гайки



Каждый комплект состоит из 5 гаек, 5 передних колец и 5 задних.

Дюймовая трубка

| Трубка, дюйм | Артикул для заказа |
|--------------|--------------------|
| 1/16 | NFS-F1- |
| 1/8 | NFS-F2- |
| 3/16 | NFS-F3- |
| 1/4 | NFS-F4- |
| 5/16 | NFS-F5- |
| 3/8 | NFS-F6- |
| 1/2 | NFS-F8- |
| 5/8 | NFS-F10- |
| 3/4 | NFS-F12- |

Метрическая трубка

| Трубка, мм | Артикул для заказа |
|------------|--------------------|
| 2 | NFS-M2- |
| 3 | NFS-M3- |
| 4 | NFS-M4- |
| 6 | NFS-M6- |
| 8 | NFS-M8- |
| 10 | NFS-M10- |
| 12 | NFS-M12- |
| 14 | NFS-M14- |
| 15 | NFS-M15- |
| 16 | NFS-M16- |
| 18 | NFS-M18- |

Набор обжимных колец



Каждый набор обжимных колец состоит из 10 передних и 10 задних колец.

Дюймовая трубка

| Трубка, дюйм | Артикул для заказа |
|--------------|--------------------|
| 1/16 | FRS-F1- |
| 1/8 | FRS-F2- |
| 3/16 | FRS-F3- |
| 1/4 | FRS-F4- |
| 5/16 | FRS-F5- |
| 3/8 | FRS-F6- |
| 1/2 | FRS-F8- |
| 5/8 | FRS-F10- |
| 3/4 | FRS-F12- |

Метрическая трубка

| Трубка, мм | Артикул для заказа |
|------------|--------------------|
| 2 | FRS-M2- |
| 3 | FRS-M3- |
| 4 | FRS-M4- |
| 6 | FRS-M6- |
| 8 | FRS-M8- |
| 10 | FRS-M10- |
| 12 | FRS-M12- |
| 14 | FRS-M14- |
| 15 | FRS-M15- |
| 16 | FRS-M16- |
| 18 | FRS-M18- |

Вставки для мягких трубок

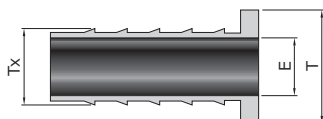

Дюймовая трубка

| T- Трубка, дюйм | Tх- Трубка, дюйм | Артикул для заказа | E дюйм (мм) |
|-----------------|------------------|--------------------|-------------|
| 3/16 | 1/8 | ISPF-3-2- | 0.09(2.3) |
| 1/4 | 1/8 | ISPF-4-2- | 0.09(2.3) |
| 1/4 | 0.17 | ISPF-4-017- | 0.11(2.8) |
| 1/4 | 3/16 | ISPF-4-3- | 0.14(3.5) |
| 5/16 | 1/8 | ISPF-5-2- | 0.09(2.3) |
| 5/16 | 3/16 | ISPF-5-3- | 0.12(3.0) |
| 5/16 | 1/4 | ISPF-5-4- | 0.19(4.8) |
| 3/8 | 3/16 | ISPF-6-3- | 0.12(3.0) |
| 3/8 | 1/4 | ISPF-6-4- | 0.19(4.8) |
| 1/2 | 1/4 | ISPF-8-4- | 0.19(4.8) |
| 1/2 | 3/8 | ISPF-8-6- | 0.31(7.9) |
| 5/8 | 3/8 | ISPF-10-6- | 0.31(7.9) |
| 5/8 | 1/2 | ISPF-10-8- | 0.44(11.1) |
| 3/4 | 1/2 | ISPF-12-8- | 0.44(11.1) |
| 3/4 | 5/8 | ISPF-12-10- | 0.56(14.2) |
| 1 | 3/4 | ISPF-16-12- | 0.69(17.5) |

Метрическая трубка

| T- Трубка, мм | Tх- Трубка, мм | Артикул для заказа | E дюйм (мм) |
|---------------|----------------|--------------------|-------------|
| 6 | 4 | ISPM-6-4- | 2.8(0.11) |
| 8 | 6 | ISPM-8-6- | 4.4(0.17) |
| 10 | 8 | ISPM-10-8- | 6.4(0.25) |
| 12 | 8 | ISPM-12-8- | 6.4(0.25) |
| 12 | 10 | ISPM-12-10- | 8.3(0.33) |

Комбинированные уплотнительные кольца BS

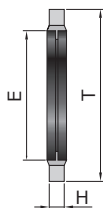

| Размер цилиндрической резьбы ISO | Артикул для заказа | Размеры, дюйм (мм) | | |
|----------------------------------|--------------------|--------------------|------------|-----------|
| | | T | E | H |
| 1/8 | BS-2- | 0.63(16.0) | 0.41(10.4) | 0.08(2.0) |
| 1/4 | BS-4- | 0.81(20.6) | 0.54(13.7) | |
| 3/8 | BS-6- | 0.94(23.9) | 0.68(17.3) | |
| 1/2 | BS-8- | 1.13(28.7) | 0.85(21.6) | 0.10(2.5) |
| 3/4 | BS-12- | 1.38(35.1) | 1.06(26.9) | |
| 1 | BS-16- | 1.69(42.9) | 1.33(33.8) | |

| Размер метрической резьбы | Артикул для заказа | Размеры, дюйм (мм) | | |
|---------------------------|--------------------|--------------------|------------|-----------|
| | | T | E | H |
| M8 x 1 | BS-MS8- | 13.0(0.51) | 8.7(0.34) | 1.0(0.04) |
| M10 x 1 | BS-MS10- | 16.0(0.63) | 10.7(0.42) | |
| M12 x 1.5 | BS-MS12- | 18.0(0.71) | 12.7(0.50) | |
| M14 x 1.5 | BS-MS14- | 22.0(0.87) | 14.7(0.58) | |
| M16 x 1.5 | BS-MS16- | 24.0(0.94) | 16.7(0.66) | |
| M18 x 1.5 | BS-MS18- | 26.0(1.02) | 18.7(0.74) | |
| M20 x 1.5 | BS-MS20- | 28.0(1.10) | 20.7(0.81) | 1.5(0.06) |
| M22 x 1.5 | BS-MS22- | 30.0(1.18) | 22.7(0.89) | |
| M24 x 1.5 | BS-MS24- | 32.0(1.26) | 24.7(0.97) | |
| M27 x 2 | BS-MS27- | 36.0(1.42) | 27.2(1.07) | |
| M30 x 2 | BS-MS30- | 39.0(1.54) | 30.7(1.21) | 2.0(0.08) |
| M33 x 2 | BS-MS33- | 42.0(1.65) | 33.7(1.33) | |
| M36 x 2 | BS-MS36- | 48.0(1.89) | 37.0(1.46) | |
| M39 x 2 | BS-MS39- | 51.0(2.01) | 40.0(1.57) | 2.5(0.10) |
| M42 x 2 | BS-MS42- | 53.0(2.09) | 42.7(1.68) | |
| M45 x 2 | BS-MS45- | 57.0(2.24) | 46.0(1.81) | 3.0(0.12) |
| M48 x 2 | BS-MS48- | 59.0(2.32) | 48.7(1.92) | |

❖ Уплотнительные кольца BS служат для уплотнения цилиндрических ISO и метрических резьб

Информация для заказа

❖ Добавьте обозначение материала в конце артикула.

| Кольцо | | Обозначение |
|-----------------------|------------|-------------|
| Внешнее | Внутреннее | |
| Нержавеющая сталь 316 | FKM | 316 |
| Углеродистая сталь | Vuna-N | CS |

Пример:

- ❖ Для заказа уплотнительного кольца под резьбу 1/8" из углеродистой стали со вставкой из Vuna, номер для заказа BS-2-CS
- ❖ Кольца BS используется с фитингами BS.

Уплотнительные медные кольца для внешней резьбы ВР

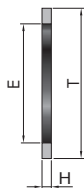

| Размер цилиндрической резьбы ISO | Артикул для заказа | Размеры, дюйм (мм) | | |
|----------------------------------|--------------------|--------------------|------------|-----------|
| | | T | E | H |
| 1/8 | BP-2- | 0.59(15.0) | 0.39(9.9) | 0.06(1.5) |
| 1/4 | BP-4- | 0.75(19.1) | 0.52(13.2) | |
| 3/8 | BP-6- | 0.91(23.1) | 0.66(16.8) | |
| 1/2 | BP-8- | 1.06(26.9) | 0.83(21.1) | 0.08(2.0) |
| 3/4 | BP-12- | 1.30(33.0) | 1.05(26.7) | |
| 1 | BP-16- | 1.69(40.1) | 1.31(33.2) | |

| Размер метрической резьбы | Артикул для заказа | Размеры, дюйм (мм) | | |
|---------------------------|--------------------|--------------------|------------|-----------|
| | | T | E | H |
| M8 x 1 | BP-MS8- | 13.2(0.52) | 8.2(0.32) | 1.5(0.06) |
| M10 x 1 | BP-MS10- | 15.2(0.60) | 10.2(0.40) | |
| M12 x 1.5 | BP-MS12- | 18.2(0.72) | 12.2(0.48) | |
| M14 x 1.5 | BP-MS14- | 20.2(0.80) | 14.2(0.56) | 2.0(0.08) |
| M16 x 1.5 | BP-MS16- | 22.2(0.87) | 16.2(0.64) | |
| M18 x 1.5 | BP-MS18- | 24.2(0.95) | 18.2(0.72) | |
| M20 x 1.5 | BP-MS20- | 26.2(1.03) | 20.2(0.80) | |
| M22 x 1.5 | BP-MS22- | 28.2(1.11) | 22.2(0.87) | |
| M24 x 1.5 | BP-MS24- | 30.2(1.19) | 24.2(0.95) | |
| M27 x 2 | BP-MS27- | 33.3(1.31) | 27.2(1.07) | 2.5(0.10) |
| M30 x 2 | BP-MS30- | 37.3(1.47) | 30.2(1.19) | |
| M33 x 2 | BP-MS33- | 40.3(1.59) | 33.2(1.37) | |
| M36 x 2 | BP-MS36- | 43.3(1.70) | 36.2(1.43) | |
| M39 x 2 | BP-MS39- | 47.3(1.86) | 39.2(1.54) | |
| M42 x 2 | BP-MS42- | 50.3(1.98) | 42.2(1.66) | |
| M45 x 2 | BP-MS45- | 53.3(2.10) | 45.2(1.78) | |
| M48 x 2 | BP-MS48- | 56.3(2.22) | 48.2(1.90) | |

❖ Уплотнительные кольца BS служат для уплотнения цилиндрических ISO и метрических резьб

❖ Кольца BP используется с фитингами ВР.

Комбинированные уплотнительные кольца ВГ

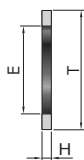

| Размер цилиндрической резьбы ISO | Артикул для заказа | Размеры, дюйм (мм) | | |
|----------------------------------|--------------------|--------------------|-----------|-----------|
| | | T | E | H |
| 1/4 | BG-4- | 0.42(10.7) | 0.30(7.6) | 0.08(2.0) |
| 3/8 | BG-6- | 0.56(14.2) | 0.34(8.6) | 0.08(2.0) |
| 1/2 | BG-8- | 0.70(17.8) | 0.36(9.1) | 0.10(2.5) |

| Размер метрической резьбы | Артикул для заказа | Размеры, дюйм (мм) | | |
|---------------------------|--------------------|--------------------|------------|-----------|
| | | T | E | H |
| M10 x 1 | BG-MS10- | 8.3(0.33) | 3.3(0.13) | 1.5(0.06) |
| M12 x 1.5 | BG-MS12- | 9.7(0.38) | 5.4(0.21) | |
| M14 x 1.5 | BG-MS14- | 11.7(0.46) | 6.4(0.25) | |
| M16 x 1.5 | BG-MS16- | 13.7(0.54) | 8.4(0.33) | 2.0(0.08) |
| M18 x 1.5 | BG-MS18- | 15.7(0.62) | 10.0(0.39) | |
| M20 x 1.5 | BG-MS20- | 18.0(0.71) | 8.0(0.31) | |
| M22 x 1.5 | BG-MS22- | 19.6(0.77) | 13.4(0.53) | |
| M24 x 1.5 | BG-MS24- | 21.6(0.85) | 14.8(0.58) | |
| M27 x 2 | BG-MS27- | 24.0(0.94) | 13.9(0.55) | |
| M30 x 2 | BG-MS30- | 27.0(1.06) | 19.5(0.77) | 2.5(0.10) |
| M33 x 2 | BG-MS33- | 30.0(1.18) | 21.5(1.85) | |
| M36 x 2 | BG-MS36- | 33.0(1.30) | 23.5(0.93) | |
| M39 x 2 | BG-MS39- | 36.0(1.42) | 24.5(1.00) | |
| M42 x 2 | BG-MS42- | 38.9(1.53) | 29.5(1.16) | |
| M45 x 2 | BG-MS45- | 41.9(1.65) | 30.0(1.18) | |
| M48 x 2 | BG-MS48- | 44.9(1.77) | 32.5(1.28) | |

Информация для заказа

❖ Добавьте обозначение материала в конце артикула.

| Материал | Обозначение |
|-----------------------|-------------|
| Медь | CU |
| Нержавеющая сталь 316 | 316 |
| PTFE | PTFE |

❖ Пример:BP-8-CU, BG-4-316, BG-MS14-CU.

Уплотнительные кольца из эластомеров



Кольца для фитингов с прямой резьбой SAE/MS

| SAE/MS Размер резьбы | Артикул для заказа | Материал |
|----------------------|--------------------|-------------------------------------|
| 5/16-24 | FKM9-902 | 90 Durometer Fluorocarbon FKM |
| 3/8-24 | FKM9-903 | |
| 7/16-20 | FKM9-904 | |
| 1/2-20 | FKM9-905 | |
| 9/16-18 | FKM9-906 | |
| 3/4-16 | FKM9-908 | |
| 7/8-14 | FKM9-910 | |
| 1 1/16-12 | FKM9-912 | |
| 1 3/16-12 | FKM9-914 | |
| 1 5/16-12 | FKM9-916 | |
| 1 5/8-12 | FKM9-920 | |
| 1 7/8-12 | FKM9-924 | |

Кольца для фитингов с трубными резьбами

| NPT/ISO Размер резьбы | Артикул для заказа | Материал |
|-----------------------|--------------------|---------------------|
| 1/8 | NBR7-013 | 70 Durometer NBR |
| 1/4 | NBR7-113 | |
| 3/8 | NBR7-116 | |
| 1/2 | NBR7-118 | |

Кольца для фитингов с цилиндрической резьбой ISO

| Размер резьбы ISO | Артикул для заказа | Материал |
|-------------------|--------------------|-------------------------------------|
| 1/8 | FKM9-502 | 90 Durometer Fluorocarbon FKM |
| 1/4 | FKM9-111 | |
| 3/8 | FKM9-113 | |
| 1/2 | FKM9-508 | |
| 3/4 | FKM9-119 | |
| 1 | FKM9-217 | |

Кольца для фитингов с цилиндрической резьбой под уплотнение

| SAE/MS Размер резьбы | Артикул для заказа | Материал |
|----------------------|--------------------|---------------------|
| 5/16-24 | NBR7-011 | 70 Durometer NBR |
| 3/8-24 | NBR7-012 | |
| 7/16-20 | NBR7-013 | |
| 1/2-20 | NBR7-112 | |
| 9/16-18 | NBR7-113 | |
| 3/4-16 | NBR7-116 | |
| 1 1/16-12 | NBR7-121 | |
| 1 5/16-12 | NBR7-125 | |

Фиксатор для монтажа на панель

- ❖ Используя фиксатор переборки, один человек может затянуть стопорную гайку на стороне А для первоначальной установки фитинга переборки. Теперь трубы могут быть подсоединены к сторонам А и В одним человеком одним гаечным ключом, поскольку фиксатор переборки действует как запасной ключ.

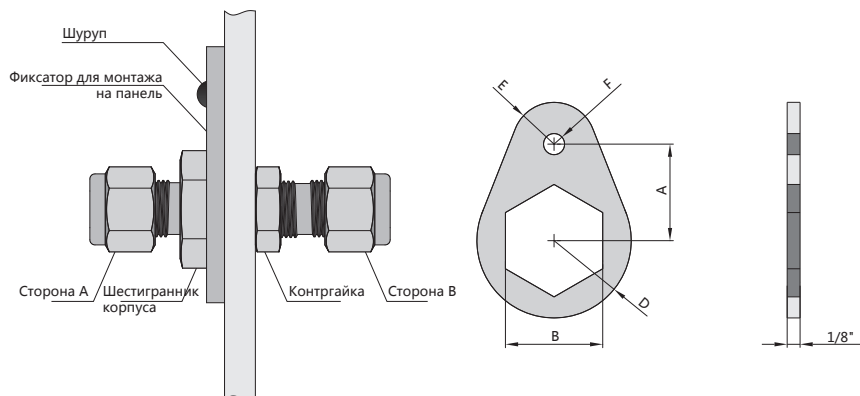

| Размер фитинга | | Артикул для заказа | Размеры, дюйм | | | | |
|----------------|-------|--------------------|---------------|--------|--------|-------|------|
| дюйм | мм | | A | B | D | E | F |
| 1/16 | — | BR-01-316 | 3/8 | 5/16 | 5/16 | 5/32 | 5/32 |
| 1/8 | — | BR-02-316 | 1/2 | 1/2 | 13/32 | 7/32 | |
| 3/16 | 3,4 | BR-03-316 | 9/16 | 9/16 | 15/32 | 1/4 | |
| 1/4 | 6 | BR-04-316 | 5/8 | 5/8 | 1/2 | 9/32 | |
| 5/16 | — | BR-05-316 | 11/16 | 11/16 | 9/16 | 5/16 | |
| — | 8 | BR-M8-316 | 11/16 | 18мм | 9/16 | 5/16 | |
| 3/8 | — | BR-06-316 | 3/4 | 3/4 | 5/8 | 11/32 | 7/32 |
| — | 10 | BR-M10-316 | 15/16 | 22мм | 3/4 | 13/32 | |
| 1/2 | 12 | BR-08-316 | 15/16 | 15/16 | 3/4 | 13/32 | |
| 5/8 | 15,16 | BR-10-316 | 1 | 1 1/16 | 13/16 | 13/32 | |
| 3/4 | 18 | BR-12-316 | 1 1/16 | 1 3/16 | 29/32 | 15/32 | |
| 7/8 | — | BR-14-316 | 1 1/8 | 1 5/16 | 1 1/32 | 17/32 | |
| 1 | — | BR-16-316 | 1 9/32 | 1 5/8 | 1 5/32 | 9/16 | |

- ❖ Включая соответствующие крепежные винты.

Как заказать

F8 — MBT — F8 — NPT8 — 316

| Тип 1 выхода | Размер 1 выхода | Обозначение конфигурации | Тип 2 выхода | Размер 2 выхода | Выходы 3 и 4 | Материал |
|----------------------------|---------------------|---|---|--------------------------|----------------------|-----------------------------------|
| M Метрич. трубка | 1 1/16" | MC Штуцер с внешней резьбой | Такой же как и 1 части ИЛИ: FNPT Внутренняя NPT | Такой как и 1 часть ИЛИ: | Такие же как 1 выход | 316 Нержавеющая сталь марки 316 |
| F Дюйм. трубка | 2 1/8" или 2 мм | VMC Штуцер с внешней резьбой и монтажом на панель | NPT Внутренняя NPT | 5 M5 x 0.8 или 5/16-24 | | 316L Нержавеющая сталь марки 316L |
| MT Метрич. трубный адаптер | 3 3/16" или 3 мм | TC Фитинг с внешней резьбой для терморлар | NPT Внешняя NPT | 6 M6 x 1 или 3/8-24 | | 304 Нержавеющая сталь марки 304 |
| FT Метрич. трубный адаптер | 4 1/4" или 4 мм | FC Фитинг с внутренней резьбой | NPT Уплотнительные кольца из эластомеров | 7 7/16-20 | | 304L Нержавеющая сталь марки 304L |
| | 5 5/16" | VFC Фланец с внутренней резьбой с креплением на панель | FBT Внутренняя FPT | 8 M8 x 1 или 1/2-20 | | A20 Сплав 20 |
| | 6 3/8" или 6 мм | U Муфта | MBT Внешняя FPT | 9 9/16-18 | | A400 Сплав 400 |
| | 8 1/2" или 8 мм | BU Муфта с монтажом на панель | MBTO Уплотнительные кольца из эластомеров с внешней FPT | 10 M10 x 1 | | A600 Сплав 600 |
| | 10 5/8" или 10 мм | ME Угольник с внешней резьбой | FBP Внутренняя FPT | 12 M12 x 1.5 или 3/4-16 | | A825 Сплав 825 |
| | 12 3/4" или 12 мм | #5ME Угольник под 45° внешней резьбой | PMBP Внешняя FPT (for BP) | 14 M14 x 1.5 или 7/8-14 | | A276 Сплав C276 |
| | 14 7/8" или 14 мм | PME Позиционируемые угольник с внешней резьбой | MBS Внешняя FPT (for BS) | 16 M16 x 1.5 | | DU7 Дуплекс 2507 |
| | 15 15 мм | FE Угольник с внутренней резьбой | MBP Внешняя FPT (for BG) | 17 1 1/16-12 | | BR Латунь |
| | 16 1" или 16 мм | UE Соединительный угольник | FMS Внутренняя FO | 18 M18 x 1.5 | | CS Углеродистая сталь |
| | 18 1 1/8" или 18 мм | MRT Тройник с внешней резьбой сбоку Тройник с внешней резьбой снизу | MS Внешняя SO (for BG) | 19 1 3/16-12 | | TT Титан |
| | 20 1 1/4" или 20 мм | MBT Тройник с внешней резьбой сбоку Тройник с внешней резьбой снизу | BPMS Внешняя SO (for BG) | 20 M20 x 1.5 | | |
| | 22 22 мм | PMBT Позиционируемый Тройник с внешней резьбой сбоку | BSMS Внешняя SO (for BS) | 21 1 5/16-12 | | |
| | 24 1 1/2" или 24 мм | FRT Тройник с внутренней резьбой сбоку | OMS Уплотнительные кольца из эластомеров с внешней ISO | 22 M22 x 1.5 | | |
| | 25 25 мм | FBT Тройник с внутренней резьбой снизу | FST Внутренняя AE | 24 M24 x 1.5 | | |
| | 28 28 мм | UT Соединительный тройник | MST Внешняя AE (for BG) | 26 1 5/8-12 | | |
| | 30 30 мм | UC Соединительная крестовина | BPST Внешняя AE (for BP) | 27 M27 x 2 | | |
| | 32 2" или 32 мм | CA Колпак | BSST Внешняя AE (for BS) | 30 1 7/8-12 | | |
| | 38 38 мм | PL Заглушка | OST Уплотнительные кольца из эластомеров с внешней SAE | | | |
| | 50 50 мм | R Переходники с трубным адаптером | PPT Позиционируемые BSP Цилиндрическая резьба | | | |
| | | PC Соединитель для фитингов | PMS Позиционируемые FO Цилиндрическая резьба | | | |
| | | MA Трубный адаптер с внешней резьбой | PST Позиционируемые AE Цилиндрическая резьба | | | |
| | | FA Трубный адаптер с внутренней резьбой | AN 37° Flare | | | |
| | | WC Штуцер под приварку | FSW Под приварку в трубу дюйм | | | |
| | | WE Угольники под приварку | FBW Под приварку в стык дюйм | | | |
| | | FLA Фланцевый переходник | MSW Под приварку в трубу метрический | | | |
| | | SFF Переходник с санитарию фланца | | | | |
| | | N Гайка | | | | |
| | | MN Гайки | | | | |
| | | RF Задние обжимные кольца | | | | |
| | | FF Передние обжимные кольца | | | | |
| | | FR Обжимные кольца | | | | |
| | | NFR Комплект обжимных колец и гайки | | | | |

