

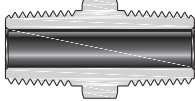

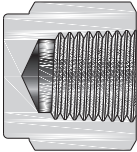
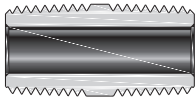
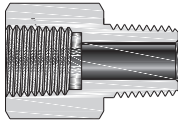
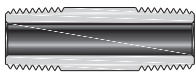
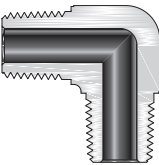

Резьбовые фитинги

Серия IPF

Содержание

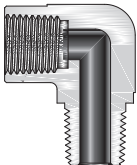
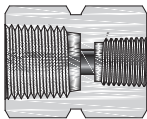
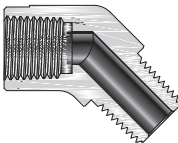
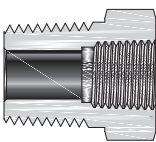
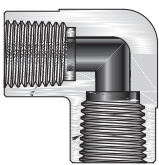
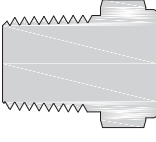
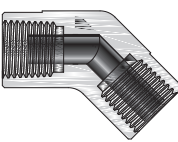
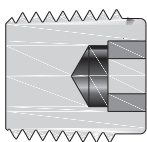
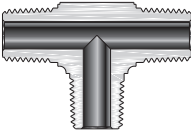
	Ниппель шестигранный		Заглушка с внутренней резьбой
5		14	
	Ниппель гладкий		Переходник
6		15	
	Специальный ниппель		Угольник с внешней резьбой
6		17	
	Удлинённый ниппель		Угольник с внутренней и внешней резьбой
8		18	
	Муфта с внутренней резьбой		Угольник с внутренней и внешней резьбой под 45°
9		20	
	Муфта с внешней резьбой		Угольник с внутренней резьбой
10	Á	22	
	ÁÁ Á		Угольник под 45° с внутренней резьбой
11		23	
	ÁÁ Á		Тройник с внешней резьбой
13		24	

Содержание

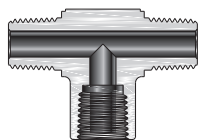

Тройник с внешними резьбами и внутренней резьбой снизу

25

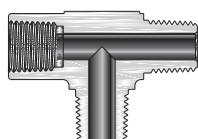

Тройник с внешними резьбами и внутренней резьбой сбоку

25

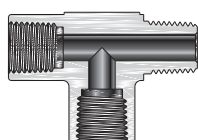

Тройник с внутренними резьбами и внешней резьбой сбоку

26

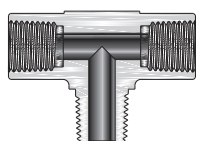

Тройник с внутренними резьбами и внешней резьбой снизу

27

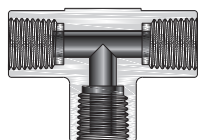

Тройник с внутренней резьбой

28

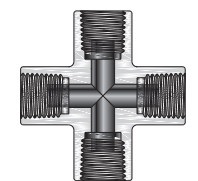

Крестовина с внутренней резьбой

29

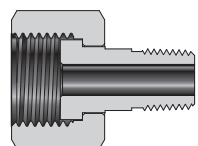

Накидная гайка M20X1.5 с внешней резьбой

29

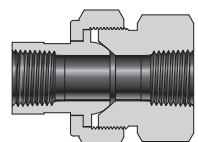

Соединитель типа «американка»

30

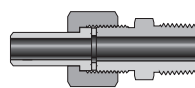

Разъёмный переходник под приварку M20x1.5 (UGJ)

30

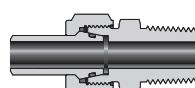

Разъёмный переходник под приварку M20x1.5 (UOJ)

31

Характеристики

- ❖ Доступны размеры от 1/16 до 2 дюймов, и от 6 до 50 мм
- ❖ Фитинги изготавливаются из нержавеющей стали, латуни и специальных сплавов.
- ❖ Изготавливаются с резьбами типа NPT, ISO/BSP, SAE и ISO.
- ❖ Превосходная обработка внутренних поверхностей

Стандарты материалов

Материал	Заготовка	Поковка
Нержавеющая сталь 316	ASTM A276 ASME SA479, EN 1.4401	ASTM A182 ASME SA182, EN 1.4401

Стандарты резьб

Тип резьбы	Стандарт
NPT	ASME B1.20.1, SAE AS71051
ISO/BSP Цилиндрическая На основе стандарта DIN 3852 Фитинги PPT, BP и BS	ISO 228, JIS B0202
ISO/BSP Коническая На основе стандарта DIN 3852 Фитинги PT	ISO 7, BS EN 10226-1, JIS B0203
ISO/BSP Манометрическая На основе стандартов EN 837-1 и 837-3 CIR-LOK BG	ISO 228
Унифицированная SAE Фитинги SA	ASME B1.1

Рабочие температуры

Material	Рабочие температуры, °F (°C)
Нержавеющая сталь 316	-321 (-196) до 1200 (649)
Латунь	-321 (-196) до 400 (204)
Углеродистая сталь	-65 (-53) до 375 (190)
Упл кольца из FKM	-5 (-15) до 400 (204)
Уплотнительные кольца из меди	-325 (-198) до 1200 (649)
Уплотнительные кольца SAE (FKM)	-20 (-28) до 400 (204)

- ❖ Температура системы может быть ограничена герметиком для резьбы или, при необходимости, материалом прокладки или уплотнительного кольца.

Шестигранный ниппель

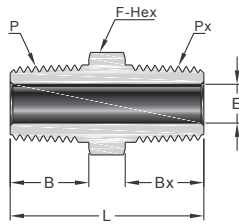

Внешняя резьба NPT

P-NPT Резьба	Px-NPT Размер	Артикул для заказа	Размеры, мм					Рабочее давление, фунт/кв. дюйм (бар)	
			L	F	B	Bx	E	Нерж. сталь 316	Латунь
1/16	1/16	NPT1-THN-NPT1-	25.6	7.9	9.7	9.7	3.0	11000 (757)	5500 (378)
1/8	1/16	NPT2-THN-NPT1-	25.6	11.1	9.7	9.7	3.0	11000 (757)	5500 (378)
1/8	1/8	NPT2-THN-NPT2-	25.6	11.1	9.7	9.7	4.8	10000 (689)	5000 (344)
1/4	1/16	NPT4-THN-NPT1-	31.0	14.3	14.2	9.7	3.0	11000 (757)	5500 (378)
1/4	1/8	NPT4-THN-NPT2-	31.0	14.3	14.2	9.7	4.8	10000 (689)	5000 (344)
1/4	1/4	NPT4-THN-NPT4-	35.6	14.3	14.2	14.2	7.1	8000 (551)	4000 (275)
3/8	1/16	NPT6-THN-NPT1-	31.8	17.5	14.2	9.7	3.0	11000 (757)	5500 (378)
3/8	1/8	NPT6-THN-NPT2-	31.8	17.5	14.2	9.7	4.8	10000 (689)	5000 (344)
3/8	1/4	NPT6-THN-NPT4-	36.3	17.5	14.2	14.2	7.1	8000 (551)	4000 (275)
3/8	3/8	NPT6-THN-NPT6-	36.3	17.5	14.2	14.2	9.6	7800 (537)	3900 (268)
1/2	1/8	NPT8-THN-NPT2-	37.3	22.2	19.1	9.7	4.8	7700 (530)	3800 (261)
1/2	1/4	NPT8-THN-NPT4-	41.9	22.2	19.1	14.2	7.1	8000 (551)	4000 (275)
1/2	3/8	NPT8-THN-NPT6-	41.9	22.2	19.1	14.2	9.6	7800 (537)	3900 (268)
1/2	1/2	NPT8-THN-NPT8-	46.7	22.2	19.1	19.1	11.9	7700 (530)	3800 (261)
3/4	1/8	NPT12-THN-NPT2-	40.4	27.0	19.1	9.7	4.8	10000 (689)	5000 (344)
3/4	1/4	NPT12-THN-NPT4-	41.9	27.0	19.1	14.2	7.1	8000 (551)	4000 (275)
3/4	3/8	NPT12-THN-NPT6-	45.2	27.0	19.1	14.2	9.6	7800 (537)	3900 (268)
3/4	1/2	NPT12-THN-NPT8-	46.7	27.0	19.1	19.1	11.9	7700 (530)	3800 (261)
3/4	3/4	NPT12-THN-NPT12-	46.7	27.0	19.1	19.1	15.7	7300 (502)	3600 (248)
1	1/8	NPT16-THN-NPT2-	45.2	34.9	23.9	9.7	4.8	10000 (689)	5000 (344)
1	1/4	NPT16-THN-NPT4-	49.3	34.9	23.9	14.2	7.1	5300 (365)	2600 (179)
1	3/8	NPT16-THN-NPT6-	50.0	34.9	23.9	14.2	9.6	7800 (537)	3900 (268)
1	1/2	NPT16-THN-NPT8-	54.1	34.9	23.9	19.1	11.9	7700 (530)	3800 (261)
1	3/4	NPT16-THN-NPT12-	54.1	34.9	23.9	19.1	15.7	7300 (502)	3600 (248)
1	1	NPT16-THN-NPT16-	58.9	34.9	23.9	23.9	22.4	5300 (365)	2600 (179)
1 1/4	1	NPT20-THN-NPT16-	62.2	44.5	23.9	23.9	22.4	5300 (365)	2600 (179)
1 1/4	1 1/4	NPT20-THN-NPT20-	62.9	44.5	23.9	23.9	28.6	6000 (410)	3000 (200)
1 1/2	1 1/2	NPT24-THN-NPT24-	66.3	50.8	26.2	26.2	34.0	5000 (344)	2500 (172)
2	2	NPT32-THN-NPT32-	77.7	69.9	26.2	26.2	45.0	3900 (268)	1900 (130)

Толстостенные ниппели с внешней резьбой NPT

1/4	1/4	NPT4-THN1-NPT4-	35.6	14.3	14.2	14.2	5.8	10000 (689)	—
1/2	1/4	NPT8-THN1-NPT4-	41.9	22.2	19.1	14.2	5.8	10000 (689)	—
1/2	1/2	NPT8-THN1-NPT8-	46.7	22.2	19.1	19.1	9.9	10000 (689)	—

Внешняя коническая резьба ISO

P-BSPT Размер	Px-BSPT Размер	Артикул для заказа	Размеры, мм					Рабочее давление, фунт/кв. дюйм (бар)	
			L	F	B	Bx	E	Нерж. сталь 316	Латунь
1/8	1/8	MBT2-THN-MBT2-	25.6	11.1	9.7	9.7	4.8	10000 (689)	5000 (344)
1/4	1/4	MBT4-THN-MBT4-	35.6	14.3	14.2	14.2	7.1	8000 (551)	4000 (275)
3/8	3/8	MBT6-THN-MBT6-	36.3	17.5	14.2	14.2	9.6	7800 (537)	3900 (268)
1/2	1/2	MBT8-THN-MBT8-	46.7	22.2	19.1	19.1	11.9	7700 (530)	3800 (261)
3/4	3/4	MBT12-THN-MBT12-	46.7	27.0	19.1	19.1	15.7	7300 (502)	3600 (248)
1	1	MBT16-THN-MBT16-	58.9	34.9	23.9	23.9	22.4	5300 (365)	2600 (179)

Шестигранный ниппель

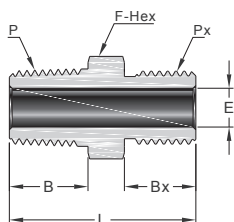

Внешняя резьба NPT

Внешняя метрическая резьба

P-NPT Размер	Px-Метрич. Размер	Артикул для заказа	Размеры, мм					Рабочее давление, фунт/кв. дюйм (бар) Нерж. сталь 316
			L	F	B	Bx	E	
1/8	M20 x 1.5	NPT2-THN-MS20-	32.7	22.2	9.7	16	5.0	7700 (530)
1/4	M8 x 1	NPT4-THN-MS8-	29.0	14.3	14.2	9	3.2	8000 (551)
1/4	M14 x 1.5	NPT4-THN-MS14-	34.2	15.9	14.2	13	7.0	8000 (551)
1/4	M16 x 1.5	NPT4-THN-MS16-	35.2	17.5	14.2	14	7.1	7800 (537)
1/4	M20 x 1.5	NPT4-THN-MS20-	37.2	22.2	14.2	16	7.1	7700 (530)
3/8	M14 x 1.5	NPT6-THN-MS14-	34.2	17.5	14.2	13	7.0	7800 (537)
3/8	M20 x 1.5	NPT6-THN-MS20-	37.2	22.2	14.2	16	9.5	7700 (530)
3/8	M24 x 1.5	NPT6-THN-MS24-	38.2	27	14.2	17	9.5	7400 (509)
1/2	M14 x 1.5	NPT8-THN-MS14-	39.1	22.2	19.1	13	7.2	7700 (530)
1/2	M20 x 1.5	NPT8-THN-MS20-	42.0	22.2	19.1	16	10.0	7700 (530)
1/2	M24 x 1.5	NPT8-THN-MS24-	43.5	27	19.1	17	11.9	7400 (509)
3/4	M20 x 1.5	NPT12-THN-MS20-	42.1	27	19.1	16	10.8	7300 (502)
3/4	M27 x 2	NPT12-THN-MS27-	46.7	31.8	19.1	18	15.8	6100 (420)
1	M30 x 2	NPT16-THN-MS30-	55.0	34.9	23.9	20	19.4	6100 (420)

Внешняя коническая резьба ISO

Внешняя метрическая резьба

P-BSPT Размер	Px-Метрич. Размер	Артикул для заказа	Размеры, мм					Рабочее давление, фунт/кв. дюйм (бар) Нерж. сталь 316
			L	F	B	Bx	E	
1/8	M20 x 1.5	MBT2-THN-MS20-	32.7	22.2	9.7	16	5.0	7700 (530)
1/4	M12 x 1.5	MBT4-THN-MS12-	33.4	14.3	14.2	15	6.0	8000 (551)
1/4	M20 x 1.5	MBT4-THN-MS20-	37.2	22.2	14.2	16	7.0	7700 (530)
3/8	M20 x 1.5	MBT6-THN-MS20-	37.2	22.2	14.2	16	9.5	7700 (530)
1/2	M20 x 1.5	MBT8-THN-MS20-	42.0	22.2	19.1	16	10.0	7700 (530)

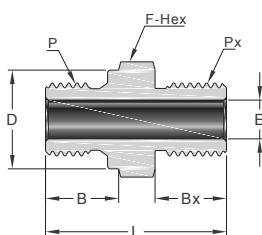

Внешняя цилиндрическая резьба ISO

Внешняя метрическая резьба

P-BS Размер	Px-Метрич. Размер	Артикул для заказа	Размеры, мм						Рабочее давление, фунт/кв. дюйм (бар) Нерж. сталь 316
			L	F	B	Bx	E	D	
1/8	M20 x 1.5	MBS2-THN-MS20-	32.6	22.2	7.1	16	4.0	13.7	7700 (530)
1/4	M18 x 1.5	MBS4-THN-MS18-	34.2	20.6	11.2	15	5.9	18.0	7800 (537)
1/4	M20 x 1.5	MBS4-THN-MS20-	37.2	22.2	11.2	16	5.9	18.0	7700 (530)
3/8	M20 x 1.5	MBS6-THN-MS20-	37.2	22.2	11.2	16	7.9	21.6	7700 (530)
1/2	M20 x 1.5	MBS8-THN-MS20-	40.2	27	14.0	16	11.9	25.9	7700 (530)

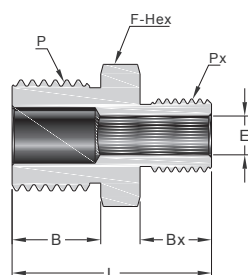

Внешняя метрическая резьба

P-Метрич. Размер	Px-Метрич. Размер	Артикул для заказа	Размеры, мм					Рабочее давление, фунт/кв. дюйм (бар) Нерж. сталь 316
			L	F	B	Bx	E	
M20 x 1.5	M10 x 1	MS20-THN-MS10-	34	22.2	16	11	4.7	10000 (689)
M20 x 1.5	M12 x 1.5	MS20-THN-MS12-	35	22.2	16	12	6.0	9000 (620)
M20 x 1.5	M14 x 1.5	MS20-THN-MS14-	36	22.2	16	13	7.2	8000 (551)
M20 x 1.5	M16 x 1.5	MS20-THN-MS16-	37	22.2	16	14	8.4	7800 (537)
M20 x 1.5	M20 x 1.5	MS20-THN-MS20-	39	22.2	16	16	10.8	7700 (530)
M27 x 2	M27 x 2	MS27-THN-MS27-	44.5	30.0	18	18	16.1	7300 (502)

Ниппель гладкий

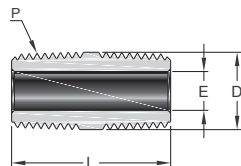

Внешняя резьба NPT

P-NPT Размер	Артикул для заказа	Размеры, мм			Рабочее давление, фунт/кв. дюйм (бар)	
		L	D	E	Нерж. сталь 316	Латунь
1/16	NPT1-TCN-NPT1-	19.1	7.9	3.0	11000 (757)	5500 (378)
1/8	NPT2-TCN-NPT2-	19.1	10.3	4.8	10000 (689)	5000 (344)
1/4	NPT4-TCN-NPT4-	28.4	13.7	7.1	8000 (551)	4000 (275)
3/8	NPT6-TCN-NPT6-	28.4	17.1	9.6	7800 (537)	3900 (268)
1/2	NPT8-TCN-NPT8-	38.1	21.3	11.9	7700 (530)	3800 (261)
3/4	NPT12-TCN-NPT12-	38.1	26.7	15.7	7300 (502)	3600 (248)
1	NPT16-TCN-NPT16-	47.8	33.4	22.4	5300 (365)	2600 (179)

Внешняя коническая резьба ISO

P-BSPT Размер	Артикул для заказа	Размеры, мм			Рабочее давление, фунт/кв. дюйм (бар)	
		L	D	E	Нерж. сталь 316	Латунь
1/16	MBT1-TCN-MBT1-	19.1	7.9	3.0	11000 (757)	5500 (378)
1/8	MBT2-TCN-MBT2-	19.1	10.3	4.8	10000 (689)	5000 (344)
1/4	MBT4-TCN-MBT4-	28.4	13.7	7.1	8000 (551)	4000 (275)
3/8	MBT6-TCN-MBT6-	28.4	17.1	9.6	7800 (537)	3900 (268)
1/2	MBT8-TCN-MBT8-	38.1	21.3	11.9	7700 (530)	3800 (261)
3/4	MBT12-TCN-MBT12-	38.1	26.7	15.7	7300 (502)	3600 (248)
1	MBT16-TCN-MBT16-	47.8	33.4	22.4	5300 (365)	2600 (179)

Специальные ниппели

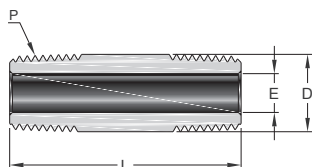

Внешняя резьба NPT

P-NPT Размер	Артикул для заказа	Размеры, мм			Рабочее давление, фунт/кв. дюйм (бар)	
		L	D	E	Нерж. сталь 316	Латунь
1/8	NPT2-TPN-NPT2-38.1-	38.1	10.3	4.8	10000 (689)	5000 (344)
1/8	NPT2-TPN-NPT2-50.8-	50.8	10.3	4.8	10000 (689)	5000 (344)
1/8	NPT2-TPN-NPT2-63.5-	63.5	10.3	4.8	10000 (689)	5000 (344)
1/8	NPT2-TPN-NPT2-76.2-	76.2	10.3	4.8	10000 (689)	5000 (344)
1/4	NPT4-TPN-NPT4-38.1-	38.1	13.7	7.1	8000 (551)	4000 (275)
1/4	NPT4-TPN-NPT4-50.8-	50.8	13.7	7.1	8000 (551)	4000 (275)
1/4	NPT4-TPN-NPT4-63.5-	63.5	13.7	7.1	8000 (551)	4000 (275)
1/4	NPT4-TPN-NPT4-76.2-	76.2	13.7	7.1	8000 (551)	4000 (275)
1/4	NPT4-TPN-NPT4-101.6-	101.6	13.7	7.1	8000 (551)	4000 (275)
3/8	NPT6-TPN-NPT6-38.1-	38.1	17.1	9.6	7800 (537)	3900 (268)
3/8	NPT6-TPN-NPT6-50.8-	50.8	17.1	9.6	7800 (537)	3900 (268)
3/8	NPT6-TPN-NPT6-63.5-	63.5	17.1	9.6	7800 (537)	3900 (268)
3/8	NPT6-TPN-NPT6-76.2-	76.2	17.1	9.6	7800 (537)	3900 (268)
3/8	NPT6-TPN-NPT6-101.6-	101.6	17.1	9.6	7800 (537)	3900 (268)
1/2	NPT8-TPN-NPT8-50.8-	50.8	21.3	11.9	7700 (530)	3800 (261)
1/2	NPT8-TPN-NPT8-76.2-	76.2	21.3	11.9	7700 (530)	3800 (261)
1/2	NPT8-TPN-NPT8-101.6-	101.6	21.3	11.9	7700 (530)	3800 (261)
1/2	NPT8-TPN-NPT8-152.4-	152.4	21.3	11.9	7700 (530)	3800 (261)
3/4	NPT12-TPN-NPT12-50.8-	50.8	26.7	15.7	7300 (502)	3600 (248)
3/4	NPT12-TPN-NPT12-76.2-	76.2	26.7	15.7	7300 (502)	3600 (248)
3/4	NPT12-TPN-NPT12-101.6-	101.6	26.7	15.7	7300 (502)	3600 (248)
1	NPT16-TPN-NPT16-76.2-	76.2	33.4	22.4	5300 (365)	2600 (179)
1	NPT16-TPN-NPT16-101.6-	101.6	33.4	22.4	5300 (365)	2600 (179)

Удлиненный nipple

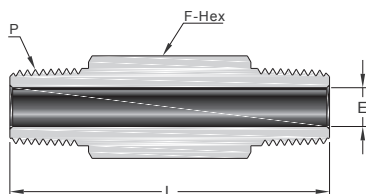

Внешняя резьба NPT

P-NPT Размер	Артикул для заказа	Размеры, мм			Рабочее давление, фунт/кв. дюйм (бар)	
		L	F	E	Нерж. сталь 316	Латунь
1/8	NPT2-TLN-NPT2-38.1-	38.1	11.1	4.8	10000 (689)	5000 (344)
1/8	NPT2-TLN-NPT2-50.8-	50.8	11.1	4.8	10000 (689)	5000 (344)
1/8	NPT2-TLN-NPT2-63.5-	63.5	11.1	4.8	10000 (689)	5000 (344)
1/8	NPT2-TLN-NPT2-76.2-	76.2	11.1	4.8	10000 (689)	5000 (344)
1/4	NPT4-TLN-NPT4-38.1-	38.1	14.3	7.1	8000 (551)	4000 (275)
1/4	NPT4-TLN-NPT4-50.8-	50.8	14.3	7.1	8000 (551)	4000 (275)
1/4	NPT4-TLN-NPT4-63.5-	63.5	14.3	7.1	8000 (551)	4000 (275)
1/4	NPT4-TLN-NPT4-76.2-	76.2	14.3	7.1	8000 (551)	4000 (275)
1/4	NPT4-TLN-NPT4-101.6-	101.6	14.3	7.1	8000 (551)	4000 (275)
3/8	NPT6-TLN-NPT6-38.1-	38.1	17.5	9.6	7800 (537)	3900 (268)
3/8	NPT6-TLN-NPT6-50.8-	50.8	17.5	9.6	7800 (537)	3900 (268)
3/8	NPT6-TLN-NPT6-63.5-	63.5	17.5	9.6	7800 (537)	3900 (268)
3/8	NPT6-TLN-NPT6-76.2-	76.2	17.5	9.6	7800 (537)	3900 (268)
3/8	NPT6-TLN-NPT6-101.6-	101.6	17.5	9.6	7800 (537)	3900 (268)
1/2	NPT8-TLN-NPT8-50.8-	50.8	22.2	11.9	7700 (530)	3800 (261)
1/2	NPT8-TLN-NPT8-76.2-	76.2	22.2	11.9	7700 (530)	3800 (261)
1/2	NPT8-TLN-NPT8-101.6-	101.6	22.2	11.9	7700 (530)	3800 (261)
1/2	NPT8-TLN-NPT8-152.4-	152.4	22.2	11.9	7700 (530)	3800 (261)
3/4	NPT12-TLN-NPT12-50.8-	50.8	27.0	15.7	7300 (502)	3600 (248)
3/4	NPT12-TLN-NPT12-76.2-	76.2	27.0	15.7	7300 (502)	3600 (248)
3/4	NPT12-TLN-NPT12-101.6-	101.6	27.0	15.7	7300 (502)	3600 (248)
1	NPT16-TLN-NPT16-76.2-	76.2	34.9	22.4	5300 (365)	2600 (179)
1	NPT16-TLN-NPT16-101.6-	101.6	34.9	22.4	5300 (365)	2600 (179)

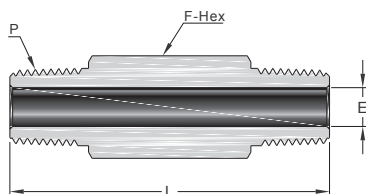

Наружная коническая резьба ISO

P-BSPT Размер	Артикул для заказа	Размеры, мм			Рабочее давление, фунт/кв. дюйм (бар)	
		L	F	E	Нерж. сталь 316	Латунь
1/8	MBT2-TLN-MBT2-38.1-	38.1	11.1	4.8	10000 (689)	5000 (344)
1/8	MBT2-TLN-MBT2-50.8-	50.8	11.1	4.8	10000 (689)	5000 (344)
1/8	MBT2-TLN-MBT2-63.5-	63.5	11.1	4.8	10000 (689)	5000 (344)
1/8	MBT2-TLN-MBT2-76.2-	76.2	11.1	4.8	10000 (689)	5000 (344)
1/4	MBT4-TLN-MBT4-38.1-	38.1	14.3	7.1	8000 (551)	4000 (275)
1/4	MBT4-TLN-MBT4-50.8-	50.8	14.3	7.1	8000 (551)	4000 (275)
1/4	MBT4-TLN-MBT4-63.5-	63.5	14.3	7.1	8000 (551)	4000 (275)
1/4	MBT4-TLN-MBT4-76.2-	76.2	14.3	7.1	8000 (551)	4000 (275)
1/4	MBT4-TLN-MBT4-101.6-	101.6	14.3	7.1	8000 (551)	4000 (275)
3/8	MBT6-TLN-MBT6-38.1-	38.1	17.5	9.6	7800 (537)	3900 (268)
3/8	MBT6-TLN-MBT6-50.8-	50.8	17.5	9.6	7800 (537)	3900 (268)
3/8	MBT6-TLN-MBT6-63.5-	63.5	17.5	9.6	7800 (537)	3900 (268)
3/8	MBT6-TLN-MBT6-76.2-	76.2	17.5	9.6	7800 (537)	3900 (268)
3/8	MBT6-TLN-MBT6-101.6-	101.6	17.5	9.6	7800 (537)	3900 (268)
1/2	MBT8-TLN-MBT8-50.8-	50.8	22.2	11.9	7700 (530)	3800 (261)
1/2	MBT8-TLN-MBT8-76.2-	76.2	22.2	11.9	7700 (530)	3800 (261)
1/2	MBT8-TLN-MBT8-101.6-	101.6	22.2	11.9	7700 (530)	3800 (261)
1/2	MBT8-TLN-MBT8-152.4-	152.4	22.2	11.9	7700 (530)	3800 (261)
3/4	MBT12-TLN-MBT12-50.8-	50.8	27.0	15.7	7300 (502)	3600 (248)
3/4	MBT12-TLN-MBT12-76.2-	76.2	27.0	15.7	7300 (502)	3600 (248)
3/4	MBT12-TLN-MBT12-101.6-	101.6	27.0	15.7	7300 (502)	3600 (248)
1	MBT16-TLN-MBT16-76.2-	76.2	34.9	22.4	5300 (365)	2600 (179)
1	MBT16-TLN-MBT16-101.6-	101.6	34.9	22.4	5300 (365)	2600 (179)

Муфта с внутренней резьбой

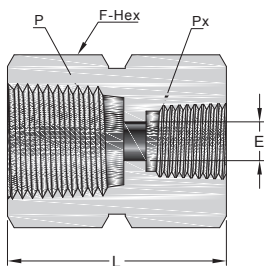

Внутренняя резьба NPT

P-NPT Резьба	Px-NPT Размер	Артикул для заказа	Размеры, мм			Рабочее давление, фунт/кв. дюйм (бар)	
			L	F	E	Нерж. сталь 316	Латунь
1/16	1/16	FNPT1-THC-FNPT1-	19.8	11.1	4.8	6700 (460)	3300 (227)
1/8	1/8	FNPT2-THC-FNPT2-	20.6	14.3	8.6	6500 (447)	3200 (220)
1/4	1/8	FNPT4-THC-FNPT2-	31.0	19.1	8.6	6600 (454)	3300 (227)
1/4	1/4	FNPT4-THC-FNPT4-	30.2	19.1	11.4	6600 (454)	3300 (227)
3/8	1/4	FNPT6-THC-FNPT4-	35.1	22.2	11.4	5300 (365)	2600 (179)
3/8	3/8	FNPT6-THC-FNPT6-	33.3	22.2	15.0	5300 (365)	2600 (179)
1/2	1/8	FNPT8-THC-FNPT2-	39.6	27.0	8.6	4900 (337)	2400 (165)
1/2	1/4	FNPT8-THC-FNPT4-	44.4	27.0	11.4	4900 (337)	2400 (165)
1/2	3/8	FNPT8-THC-FNPT6-	45.2	27.0	15.0	4900 (337)	2400 (165)
1/2	1/2	FNPT8-THC-FNPT8-	39.6	27.0	18.5	4900 (337)	2400 (165)
3/4	1/4	FNPT12-THC-FNPT4-	46.0	33.3	11.4	4600 (316)	2300 (158)
3/4	1/2	FNPT12-THC-FNPT8-	52.3	33.3	18.5	4600 (316)	2300 (158)
3/4	3/4	FNPT12-THC-FNPT12-	41.1	33.3	23.9	4600 (316)	2300 (158)
1	1/2	FNPT16-THC-FNPT8-	55.6	41.3	18.5	4400 (303)	2200 (151)
1	3/4	FNPT16-THC-FNPT12-	57.2	41.3	23.9	4400 (303)	2200 (151)
1	1	FNPT16-THC-FNPT16-	50.8	41.3	29.7	4400 (303)	2200 (151)
Толстостенные ниппели с внутренней резьбой NPT							
1/4	1/4	FNPT4-THC1-FNPT4-	30.2	25.4	11.4	10000 (689)	—
1/2	1/4	FNPT8-THC1-FNPT4-	44.4	38.1	11.4	10000 (689)	—
1/2	1/2	FNPT8-THC1-FNPT8-	39.6	38.1	18.5	10000 (689)	—

Внутренняя коническая резьба ISO

P-BSPT Размер	Px-BSPT Размер	Артикул для заказа	Размеры, мм			Рабочее давление, фунт/кв. дюйм (бар)	
			L	F	E	Нерж. сталь 316	Латунь
1/8	1/8	FBT2-THC-FBT2-	20.6	14.3	8.4	6500 (447)	3200 (220)
1/4	1/4	FBT4-THC-FBT4-	30.2	19.1	11.2	6600 (454)	3300 (227)
3/8	1/4	FBT6-THC-FBT4-	35.1	22.2	11.2	5300 (365)	2600 (179)
3/8	3/8	FBT6-THC-FBT6-	33.3	22.2	14.7	5300 (365)	2600 (179)
1/2	1/4	FBT8-THC-FBT4-	44.4	27.0	11.2	4900 (337)	2400 (165)
1/2	3/8	FBT8-THC-FBT6-	45.2	27.0	14.7	4900 (337)	2400 (165)
1/2	1/2	FBT8-THC-FBT8-	39.6	27.0	18.3	4900 (337)	2400 (165)

Переходная муфта

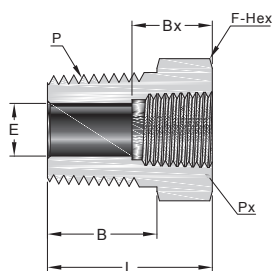

Внешняя резьба NPT

Внутренняя резьба NPT

P-NPT Размер	Px-NPT Размер	Артикул для заказа	Размеры, мм					Рабочее давление, фунт/кв. дюйм (бар)	
			L	F	B	Bx	E	Нерж. сталь 316	Латунь
1/8	1/16	NPT2-TRB-FNPT1-	26.2	11.1	9.7	9.9	4.8	6500 (447)	3200 (220)
1/4	1/16	NPT4-TRB-FNPT1-	21.8	14.3	14.2	9.9	4.8	8000 (551)	4000 (275)
1/4	1/8	NPT4-TRB-FNPT2-	26.9	14.3	14.2	10.4	7.1	6500 (447)	3300 (227)
3/8	1/16	NPT6-TRB-FNPT1-	21.8	17.5	14.2	9.9	4.8	13300 (971)	6600 (454)
3/8	1/8	NPT6-TRB-FNPT2-	21.8	17.5	14.2	10.4	8.6	9200 (633)	4700 (323)
3/8	1/4	NPT6-TRB-FNPT4-	30.2	19.1	14.2	15.0	9.6	6600 (454)	3300 (227)
1/2	1/8	NPT8-TRB-FNPT2-	27.4	22.2	19.1	10.4	8.6	12200 (840)	6200 (427)
1/2	1/4	NPT8-TRB-FNPT4-	27.4	22.2	19.1	15.0	11.4	8300 (571)	4400 (303)
1/2	3/8	NPT8-TRB-FNPT6-	35.8	22.2	19.1	15.0	11.9	5300 (365)	2600 (179)
3/4	1/8	NPT12-TRB-FNPT2-	27.4	27.0	19.1	10.4	7.1	20000(1378)	10000(689)
3/4	1/4	NPT12-TRB-FNPT4-	27.4	27.0	19.1	15.0	11.4	12000 (826)	6000 (410)
3/4	3/8	NPT12-TRB-FNPT6-	27.4	27.0	19.1	15.0	15.0	8200 (564)	4300 (296)
3/4	1/2	NPT12-TRB-FNPT8-	41.4	27.0	19.1	19.8	15.7	4900 (337)	2400 (165)
1	1/8	NPT16-TRB-FNPT2-	34.8	34.9	23.9	10.4	7.1	20000(1378)	10000(689)
1	1/4	NPT16-TRB-FNPT4-	34.8	34.9	23.9	15.0	11.4	14500 (999)	7400 (509)
1	3/8	NPT16-TRB-FNPT6-	34.8	34.9	23.9	15.0	15.0	11600 (799)	5900 (406)
1	1/2	NPT16-TRB-FNPT8-	34.8	34.9	23.9	19.8	18.5	8600 (592)	4300 (296)
1	3/4	NPT16-TRB-FNPT12-	47.0	34.9	23.9	20.6	22.4	5300 (365)	2600 (179)
1 1/4	3/4	NPT20-TRB-FNPT12-	37.3	44.5	23.9	20.6	22.4	7800 (537)	3900 (268)
1 1/4	1	NPT20-TRB-FNPT16-	37.3	44.5	23.9	25.4	22.4	3500 (241)	1750 (120)
1 1/2	1	NPT24-TRB-FNPT16-	40.1	50.8	26.2	25.4	22.4	6600 (454)	3300 (227)
1 1/2	1 1/4	NPT24-TRB-FNPT20-	56.0	54.0	26.2	25.4	34.0	5000 (344)	2500 (172)

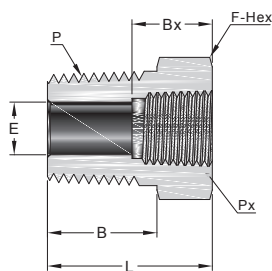

Внешняя резьба NPT

Внутренняя коническая ISO

P-NPT Размер	Px-BSPT Размер	Артикул для заказа	Размеры, мм					Рабочее давление, фунт/кв. дюйм (бар)	
			L	F	B	Bx	E	Нерж. сталь 316	Латунь
1/8	1/16	NPT2-TRB-FBT1-	26.2	11.1	9.7	9.9	4.8	6500 (447)	3200 (220)
1/4	1/16	NPT4-TRB-FBT1-	21.8	14.3	14.2	9.9	4.8	8000 (551)	4000 (275)
1/4	1/8	NPT4-TRB-FBT2-	26.9	14.3	14.2	10.4	7.1	6500 (447)	3300 (227)
3/8	1/16	NPT6-TRB-FBT1-	21.8	17.5	14.2	9.9	4.8	13300 (917)	6600 (454)
3/8	1/8	NPT6-TRB-FBT2-	21.8	17.5	14.2	10.4	7.1	9200 (633)	4700 (323)
3/8	1/4	NPT6-TRB-FBT4-	30.2	19.1	14.2	15.0	9.6	6600 (454)	3300 (227)
1/2	1/8	NPT8-TRB-FBT2-	27.4	22.2	19.1	10.4	7.1	12200 (840)	6200 (427)
1/2	1/4	NPT8-TRB-FBT4-	27.4	22.2	19.1	15.0	10.4	8300 (571)	4400 (303)
1/2	3/8	NPT8-TRB-FBT6-	35.8	22.2	19.1	15.0	11.9	5300 (365)	2600 (179)
3/4	1/8	NPT12-TRB-FBT2-	27.4	27.0	19.1	10.4	7.1	20000 (1378)	10000 (689)
3/4	1/4	NPT12-TRB-FBT4-	27.4	27.0	19.1	15.0	10.4	12000 (826)	6000 (410)
3/4	3/8	NPT12-TRB-FBT6-	27.4	27.0	19.1	15.0	12.7	8200 (564)	4300 (296)
3/4	1/2	NPT12-TRB-FBT8-	41.4	27.0	19.1	19.8	15.7	4900 (337)	2400 (165)
1	1/8	NPT16-TRB-FBT2-	34.8	34.9	23.9	10.4	7.1	20000 (1378)	10000 (689)
1	1/4	NPT16-TRB-FBT4-	34.8	34.9	23.9	15.0	10.4	14500 (999)	7400 (509)
1	3/8	NPT16-TRB-FBT6-	34.8	34.9	23.9	15.0	12.7	11600 (799)	5900 (406)
1	1/2	NPT16-TRB-FBT8-	34.8	34.9	23.9	19.8	15.7	8600 (592)	4300 (296)
1	3/4	NPT16-TRB-FBT12-	47.0	34.9	23.9	20.6	22.4	5300 (365)	2600 (179)
1 1/4	3/4	NPT20-TRB-FBT12-	37.3	44.5	23.9	20.6	22.4	7800 (537)	3900 (268)
1 1/4	1	NPT20-TRB-FBT16-	37.3	44.5	23.9	25.4	22.4	3500 (241)	1750 (120)
1 1/2	1	NPT24-TRB-FBT16-	40.1	50.8	26.2	25.4	22.4	6600 (454)	3300 (227)
1 1/2	1 1/4	NPT24-TRB-FBT20-	56.0	54.0	26.2	25.4	34.0	5000 (344)	2500 (172)

Переходная муфта

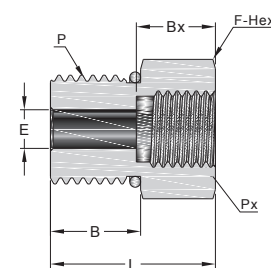
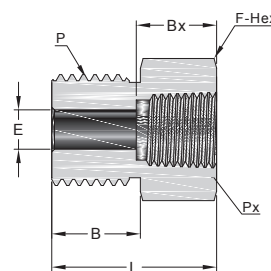
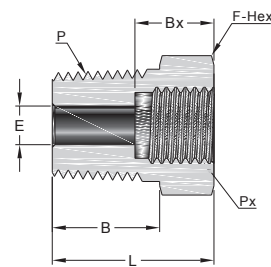
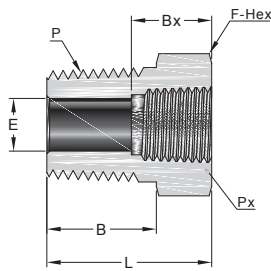

Внешняя коническая резьба ISO

Внутренняя коническая резьба ISO

P-BSPT Размер	Px-BSPT Размер	Артикул для заказа	Размеры, мм					Рабочее давление, фунт/кв. дюйм (бар)	
			L	F	B	Bx	E	Нерж. сталь 316	Латунь
1/4	1/8	MBT4-TRB-FBT2-	26.9	14.3	14.2	10.4	7.1	6500 (447)	3200 (220)
3/8	1/4	MBT6-TRB-FBT4-	30.2	19.1	14.2	15.0	9.6	6600 (454)	3300 (227)
1/2	1/4	MBT8-TRB-FBT4-	27.4	22.2	19.1	15.0	11.2	8300 (571)	4400 (303)
1/2	3/8	MBT8-TRB-FBT6-	35.8	22.2	19.1	15.0	11.9	5300 (365)	2600 (179)

Внешняя резьба NPT

Внутренняя цилиндрическая резьба ISO

P-NPT Размер	Px-BG Размер	Артикул для заказа	Размеры, мм					Рабочее давление, фунт/кв. дюйм (бар)	
			L	F	B	Bx	E	Нерж. сталь 316	Латунь
3/8	1/4	NPT6-TRB-FBP4-	30.2	19.1	14.2	12.9	5.6	5700 (392)	
1/2	3/8	NPT8-TRB-FBP6-	35.8	22.2	19.1	14.2	6.6	5700 (392)	
3/4	1/2	NPT12-TRB-FBP8-	41.4	27.0	19.1	18.8	7.1	3900 (268)	

Внешняя цилиндрическая резьба ISO

Внутренняя резьба NPT

P-BG Размер	Px-NPT Размер	Артикул для заказа	Размеры, мм					Рабочее давление, фунт/кв. дюйм (бар)	
			L	F	B	Bx	E	Нерж. сталь 316	Латунь
1/4	1/8	MBP4-TRB-FNPT2-	26.9	14.3	12.9	10.4	4.5	6500 (447)	3200 (220)
3/8	1/4	MBP6-TRB-FNPT4-	31.0	19.1	14.2	15	7.1	6600 (454)	3300 (227)
1/2	3/8	MBP8-TRB-FNPT6-	35.8	22.2	18.8	15	6.6	5300 (365)	2600 (179)

Внешняя прямая резьба SAE

Внутренняя прямая резьба MS

P- SAE/MS Размер	Px- SAE/MS Размер	Артикул для заказа	Размеры, мм					Рабочее давление, фунт/кв. дюйм (бар)	
			L	F	B	Bx	E	Нерж. сталь 316	Латунь
9/16-18	7/16-20	OST9-TRB-FST7-	28.4	20.6	9.9	14.0	7.1	4500 (310)	
3/4-16	7/16-20	OST12-TRB-FST7-	24.9	22.2	11.2	14.0	9.9	4500 (310)	
3/4-16	9/16-18	OST12-TRB-FST9-	30.2	25.4	11.2	16.0	10.7	4500 (310)	
7/8-14	9/16-18	OST14-TRB-FST9-	27.9	25.4	12.7	16.0	12.7	3600 (248)	
7/8-14	3/4-16	OST14-TRB-FST12-	36.1	30.2	12.7	18.0	12.7	3600 (248)	
1 1/16-12	3/4-16	OST17-TRB-FST12-	32.3	31.8	15.0	18.0	16.5	3600 (248)	
1 5/16-12	1 1/16-12	OST21-TRB-FST17-	40.9	41.3	15.0	24.0	22.1	2900 (199)	
1 5/8-12	1 5/16-12	OST26-TRB-FST21-	50.3	54.0	15.0	24.0	27.7	2300 (158)	
1 7/8-12	1 5/16-12	OST30-TRB-FST21-	50.3	54.0	15.0	24.0	31.2	2300 (158)	

Заглушка с внешней резьбой

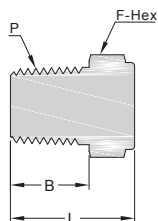

Внешняя резьба NPT

P-NPT Размер	Артикул для заказа	Размеры, мм		
		L	F	B
1/16	TP-NPT1-	14.2	7.9	9.7
1/8	TP-NPT2-	14.2	11.1	9.7
1/4	TP-NPT4-	19.1	14.3	14.2
3/8	TP-NPT6-	19.8	17.5	14.2
1/2	TP-NPT8-	24.6	22.2	19.1
3/4	TP-NPT12-	30.7	27.0	19.1
1	TP-NPT16-	38.1	34.9	23.9
1 1/4	TP-NPT20-	38.4	44.5	23.9
1 1/2	TP-NPT24-	43.7	50.8	26.2
2	TP-NPT32-	50.8	69.9	26.2

Внешняя коническая резьба ISO

P-BSPT Размер	Артикул для заказа	Размеры, мм		
		L	F	B
1/16	TP-MBT1-	14.2	7.9	9.7
1/8	TP-MBT2-	14.2	11.1	9.7
1/4	TP-MBT4-	19.1	14.3	14.2
3/8	TP-MBT6-	19.8	17.5	14.2
1/2	TP-MBT8-	24.6	22.2	19.1
3/4	TP-MBT12-	30.7	27.0	19.1
1	TP-MBT16-	38.1	34.9	23.9
1 1/4	TP-MBT20-	38.4	44.5	23.9
1 1/2	TP-MBT24-	43.7	50.8	26.2
2	TP-MBT32-	50.8	69.9	26.2

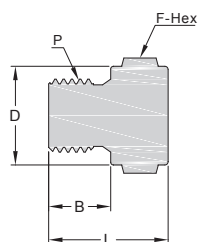

Внешняя цилиндрическая резьба ISO

P-BS Размеры	Артикул для заказа	Размеры, мм			
		L	F	B	D
1/8	TP-MBS2-	14.0	14.3	7.1	13.7
1/4	TP-MBS4-	19.8	19.1	11.2	18.0
3/8	TP-MBS6-	19.8	22.2	11.2	21.8
1/2	TP-MBS8-	25.1	27.0	14.0	25.9
3/4	TP-MBS12-	28.7	33.3	15.7	32.0
1	TP-MBS16-	30.7	41.3	18.0	39.1

Внешняя метрическая резьба

P- Метрич. Размеры	Артикул для заказа	Размеры, мм			
		L	F	B	D
M14 x 1.5	TP-BSMS14-	21	20.6	12	18.8
M16 x 1.5	TP-BSMS16-	23	22.2	12	20.8
M18 x 1.5	TP-BSMS18-	25	23.8	12	22.8
M20 x 1.5	TP-BSMS20-	26.5	25.4	14	24.8
M22 x 1.5	TP-BSMS22-	28.8	28.6	14	26.8
M24 x 1.5	TP-BSMS24-	29	35.0	14	28.8
M27 x 2	TP-BSMS27-	30	36.5	16	31.8

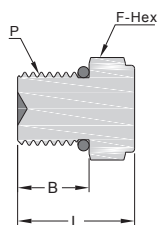

Прямая внешняя резьба SAE/MS

P-SAE/MS Размеры	Артикул для заказа	Размеры, мм		
		L	F	B
7/16-20	TP-OST7-	19.3	14.3	9.1
9/16-18	TP-OST9-	20.8	17.5	9.9
3/4-16	TP-OST12-	22.6	22.2	11.2
1 1/16-12	TP-OST17-	28.4	31.8	15.0
1 5/16-12	TP-OST21-	30.0	38.1	15.0

Заглушка с внешней резьбой

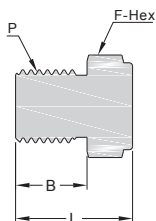

Внешняя метрическая резьба

P- Метрич. Резьба	Артикул для заказа	Размеры, мм		
		L	F	B
M14 x 1.5	TP-MS14-	18	16	13
M16 x 1.5	TP-MS16-	20	18	14
M18 x 1.5	TP-MS18-	22	19	15
M20 x 1.5	TP-MS20-	24	22	16
M22 x 1.5	TP-MS22-	26	24	17
M24 x 1.5	TP-MS24-	26	27	17
M27 x 2	TP-MS27-	27	30	18
M30 x 2	TP-MS30-	32	32	20

Заглушка с внутренним шестигранником

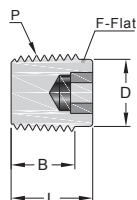

Внешняя коническая резьба ISO

P-BSPT Размер	Артикул для заказа	Размеры, мм			
		L	F	B	D
1/16	THP-MBT1-	7.6	4.0	7.4	7.4
1/8	THP-MBT2-	10.4	4.8	7.4	9.4
1/4	THP-MBT4-	15.5	6.4	12.4	12.1
3/8	THP-MBT6-	15.5	7.9	12.4	15.7
1/2	THP-MBT8-	19.3	9.5	16.2	19.3
3/4	THP-MBT12-	19.8	14.3	16.7	25.7
1	THP-MBT16-	20.8	15.9	17.7	31.8

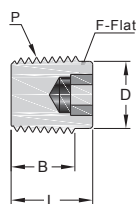

Внешняя резьба NPT

P-NPT Размер	Артикул для заказа	Размеры, мм			
		L	F	B	D
1/16	THP-NPT1-	7.6	4.0	7.4	7.4
1/8	THP-NPT2-	10.4	4.8	7.4	9.4
1/4	THP-NPT4-	15.5	6.4	12.4	12.1
3/8	THP-NPT6-	15.0	7.9	11.9	15.7
1/2	THP-NPT8-	19.3	9.5	16.2	19.3
3/4	THP-NPT12-	19.8	14.3	16.7	25.7
1	THP-NPT16-	20.8	15.9	17.7	31.8

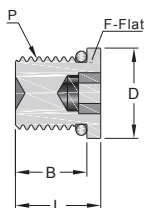

Внешняя прямая резьба SAE/MS

P-SAE/MS Размер	Артикул для заказа	Размеры, мм			
		L	F	B	D
7/16-20	THP-OST7-	11.4	4.8	9.1	14.2
9/16-18	THP-OST9-	12.2	6.4	9.9	17.5
3/4-16	THP-OST12-	14.2	7.9	11.2	22.4
1 1/16-12	THP-OST17-	19.1	14.3	15.0	31.8
1 5/16-12	THP-OST21-	19.1	15.9	15.0	38.1

Заглушка с внутренней резьбой

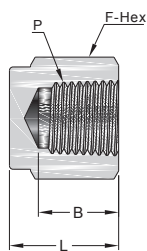

Внутренняя резьба NPT

P-NPT Резьба	Артикул для заказа	Размеры, мм			Рабочее давление, фунт/кв. дюйм (бар)	
		L	F	B	Нерж. сталь 316	Латунь
1/16	PC-FNPT1-	12.7	11.1	9.9	6700 (460)	3300 (227)
1/8	PC-FNPT2-	19.1	14.3	10.4	6500 (447)	3200 (220)
1/4	PC-FNPT4-	23.1	19.1	15.0	6600 (454)	3300 (277)
3/8	PC-FNPT6-	26.2	22.2	15.0	5300 (365)	2600 (179)
1/2	PC-FNPT8-	34.0	27.0	19.8	4900 (337)	2400 (165)
3/4	PC-FNPT12-	36.6	33.3	20.6	4600 (316)	2300 (158)
1	PC-FNPT16-	41.1	41.3	25.4	4400 (303)	2200 (151)
Толстостенные ниппели с внутренней резьбой NPT						
1/4	PC1-FNPT4	28.2	25.4	15.0	10000 (689)	—
1/2	PC1-FNPT8	40.1	38.1	19.8	10000 (689)	—

Внутренняя коническая резьба ISO

P-BSPT Резьба	Артикул для заказа	Размеры, мм			Рабочее давление, фунт/кв. дюйм (бар)	
		L	F	B	Нерж. сталь 316	Латунь
1/16	PC-FBT1-	12.7	11.1	9.9	6700 (460)	3300 (227)
1/8	PC-FBT2-	19.1	14.3	10.4	6500 (447)	3200 (220)
1/4	PC-FBT4-	23.1	19.1	15.0	6600 (454)	3300 (277)
3/8	PC-FBT6-	26.2	22.2	15.0	5300 (365)	2600 (179)
1/2	PC-FBT8-	34.0	27.0	19.8	4900 (337)	2400 (165)
3/4	PC-FBT12-	36.6	33.3	20.6	4600 (316)	2300 (158)
1	PC-FBT16-	41.1	41.3	25.4	4400 (303)	2200 (151)

Переходник

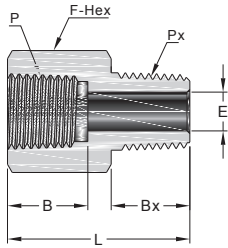

Внутренняя резьба NPT

Внешняя резьба NPT

P-NPT Размер	Px-NPT Размер	Артикул для заказа	Размеры, мм					Рабочее давление, фунт/кв. дюйм (бар)	
			L	F	B	Bx	E	Нерж. сталь 316	Латунь
1/8	1/16	FNPT2-TA-NPT1-	27.7	14.3	10.4	9.7	3.0	6500 (447)	3200 (220)
1/8	1/8	FNPT2-TA-NPT2-	27.9	14.3	10.4	9.7	4.8	6500 (447)	3200 (220)
1/4	1/16	FNPT4-TA-NPT1-	30.5	19.1	15.0	9.7	3.0	6600 (454)	3300 (227)
1/4	1/8	FNPT4-TA-NPT2-	32.0	19.1	15.0	9.7	4.8	6600 (454)	3300 (227)
1/4	1/4	FNPT4-TA-NPT4-	35.6	19.1	15.0	14.2	7.1	6600 (454)	3300 (227)
3/8	1/16	FNPT6-TA-NPT1-	31.8	22.2	15.0	9.7	3.0	5300 (365)	2600 (179)
3/8	1/8	FNPT6-TA-NPT2-	33.8	22.2	15.0	9.7	4.8	5300 (365)	2600 (179)
3/8	1/4	FNPT6-TA-NPT4-	38.1	22.2	15.0	14.2	7.1	5300 (365)	2600 (179)
3/8	3/8	FNPT6-TA-NPT6-	38.4	22.2	15.0	14.2	9.6	5300 (365)	2600 (179)
1/2	1/8	FNPT8-TA-NPT2-	40.1	27.0	19.8	9.7	4.8	4900 (337)	2400 (165)
1/2	1/4	FNPT8-TA-NPT4-	44.7	27.0	19.8	14.2	7.1	4900 (337)	2400 (165)
1/2	3/8	FNPT8-TA-NPT6-	44.4	27.0	19.8	14.2	9.6	4900 (337)	2400 (165)
1/2	1/2	FNPT8-TA-NPT8-	49.3	27.0	19.8	19.1	11.9	4900 (337)	2400 (165)
3/4	1/8	FNPT12-TA-NPT2-	39.6	33.3	20.6	9.7	4.8	4600 (316)	2300 (158)
3/4	1/4	FNPT12-TA-NPT4-	47.0	33.3	20.6	14.2	7.1	4600 (316)	2300 (158)
3/4	3/8	FNPT12-TA-NPT6-	46.2	33.3	20.6	14.2	9.6	4600 (316)	2300 (158)
3/4	1/2	FNPT12-TA-NPT8-	51.3	33.3	20.6	19.1	11.9	4600 (316)	2300 (158)
3/4	3/4	FNPT12-TA-NPT12-	51.3	33.3	20.6	19.1	15.7	4600 (316)	2300 (158)
1	1/8	FNPT16-TA-NPT2-	46.0	41.3	25.4	9.7	4.8	4400 (303)	2200 (151)
1	1/4	FNPT16-TA-NPT4-	49.8	41.3	25.4	14.2	7.1	4400 (303)	2200 (151)
1	3/8	FNPT16-TA-NPT6-	50.8	41.3	25.4	14.2	9.6	4400 (303)	2200 (151)
1	1/2	FNPT16-TA-NPT8-	54.9	41.3	25.4	19.1	11.9	4400 (303)	2200 (151)
1	3/4	FNPT16-TA-NPT12-	55.1	41.3	25.4	19.1	15.7	4400 (303)	2200 (151)
1	1	FNPT16-TA-NPT16-	57.9	41.3	25.4	23.9	22.4	4400 (303)	2200 (151)
1 1/4	1	FNPT20-TA-NPT16-	62.7	54.0	25.4	23.9	22.4	5000 (344)	2500 (172)
Толстостенный ниппель с внутренней и наружной резьбой NPT									
1/4	1/4	FNPT4-TA1-NPT4-	36.3	25.4	15.0	14.2	5.8	10000 (689)	/
1/2	1/4	FNPT8-TA1-NPT4-	46.0	38.1	19.8	14.2	5.8	10000 (689)	/
1/2	1/2	FNPT8-TA1-NPT8-	51.3	38.1	19.8	19.1	9.9	10000 (689)	/

Переходник

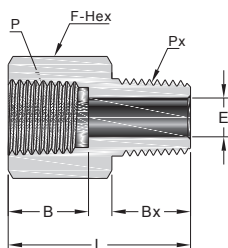

Внутренняя резьба NPT

Внешняя коническая резьба ISO

P-NPT Размер	Px-BSPT Размер	Артикул для заказа	Размеры, мм					Рабочее давление, фунт/кв. дюйм (бар)	
			L	F	B	Bx	E	Нерж. сталь 316	Латунь
1/8	1/8	FNPT2-TA-MBT2-	27.7	14.3	10.4	9.7	4.8	6500 (447)	3200 (220)
1/4	1/4	FNPT4-TA-MBT4-	36.1	19.1	15.0	14.2	7.1	6600 (454)	3300 (227)
3/8	3/8	FNPT6-TA-MBT6-	38.1	22.2	15.0	14.2	9.6	5300 (365)	2600 (179)
1/2	1/2	FNPT8-TA-MBT8-	49.3	27.0	19.8	19.1	11.9	4900 (337)	2400 (165)
3/4	3/4	FNPT12-TA-MBT12-	51.3	33.3	20.6	19.1	15.7	4600 (316)	2300 (158)
1	1	FNPT16-TA-MBT16-	58.4	41.3	25.4	23.9	22.4	4400 (303)	2200 (151)

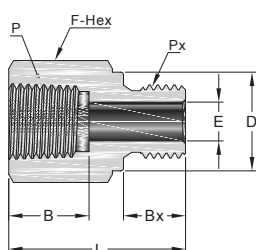

Внутренняя резьба NPT

Внешняя цилиндрическая резьба ISO

P-NPT Размер	Px-BS Размер	Артикул для заказа	Размеры, мм							Рабочее давление, фунт/кв. дюйм (бар)	
			L	F	B	Bx	D	E	Нерж. сталь 316	Латунь	
1/8	1/8	FNPT2-TA-MBS2-	25.1	14.3	9.9	7.1	13.7	4.1	6500 (447)	3200 (220)	
1/4	1/4	FNPT4-TA-MBS4-	33.5	19.1	10.4	11.2	18.0	5.8	6600 (454)	3300 (227)	
3/8	3/8	FNPT6-TA-MBS6-	35.8	22.2	15.0	11.2	21.6	7.9	5300 (365)	2600 (179)	
1/2	1/2	FNPT8-TA-MBS8-	44.2	27.0	15.0	14.2	25.9	11.9	4900 (337)	2400 (165)	
3/4	3/4	FNPT12-TA-MBS12-	48.0	33.3	20.6	15.7	32.0	15.7	4600 (316)	2300 (158)	
1	1	FNPT16-TA-MBS16-	53.3	41.3	25.4	18.3	38.9	19.8	4400 (303)	2200 (151)	

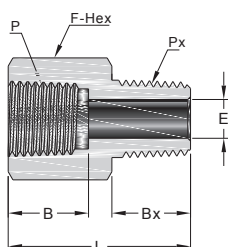

Внутренняя коническая резьба ISO

Внешняя коническая резьба ISO

P-BSPT Размер	Px-BSPT Размер	Артикул для заказа	Размеры, мм					Рабочее давление, фунт/кв. дюйм (бар)	
			L	F	B	Bx	E	Нерж. сталь 316	Латунь
1/8	1/8	FBT2-TA-MBT2-	27.7	14.3	10.4	9.7	4.8	6500 (447)	3200 (220)
1/4	1/8	FBT4-TA-MBT2-	32.0	19.1	15.0	9.7	4.8	6600 (454)	3300 (227)
1/4	1/4	FBT4-TA-MBT4-	36.1	19.1	15.0	14.2	7.1	6600 (454)	3300 (227)
3/8	1/4	FBT6-TA-MBT4-	38.1	22.2	15.0	14.2	7.1	5300 (365)	2600 (179)
3/8	3/8	FBT6-TA-MBT6-	38.1	22.2	15.0	14.2	9.6	5300 (365)	2600 (179)
1/2	1/4	FBT8-TA-MBT4-	44.7	27.0	19.8	14.2	7.1	4900 (337)	2400 (165)
1/2	3/8	FBT8-TA-MBT6-	44.4	27.0	19.8	14.2	9.6	4900 (337)	2400 (165)
1/2	1/2	FBT8-TA-MBT8-	49.5	27.0	19.8	19.1	11.9	4900 (337)	2400 (165)
3/4	3/4	FBT12-TA-MBT12-	51.3	33.3	20.6	19.1	15.7	4600 (316)	2300 (158)
1	1	FBT16-TA-MBT16-	58.4	41.3	25.4	23.9	22.4	4400 (303)	2200 (151)

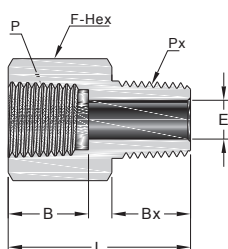

Внутренняя коническая резьба ISO

Внешняя резьба NPT

P-BSPT Размер	Px-NPT Размер	Артикул для заказа	Размеры, мм					Рабочее давление, фунт/кв. дюйм (бар)	
			L	F	B	Bx	E	Нерж. сталь 316	Латунь
1/8	1/8	FBT2-TA-NPT2-	27.7	14.3	10.4	9.7	4.8	6500 (447)	3200 (220)
1/4	1/4	FBT4-TA-NPT4-	36.3	19.1	15.0	14.2	7.1	6600 (454)	3300 (227)
3/8	3/8	FBT6-TA-NPT6-	38.4	22.2	15.0	14.2	9.6	5300 (365)	2600 (179)
1/2	1/2	FBT8-TA-NPT8-	49.8	27.0	19.8	19.1	11.9	4900 (337)	2400 (165)
3/4	3/4	FBT12-TA-NPT12-	51.3	33.3	20.6	19.1	15.7	4600 (316)	2300 (158)
1	1	FBT16-TA-NPT16-	58.4	41.3	25.4	23.9	22.4	4400 (303)	2200 (151)

Переходник

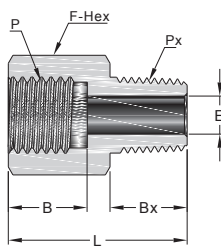
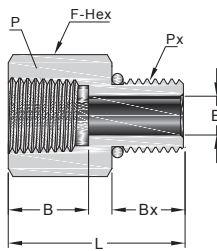

Внутренняя резьба NPT

Внешняя прямая резьба SAE/MS

P-NPT Размер	Px-SAE/MS Размер	Артикул для заказа	Размеры, мм					Рабочее давление, фунт/кв. дюйм (бар) Нерж. сталь 316
			L	F	B	Bx	E	
1/4	7/16-20	FNPT4-TA-OST7-	33.5	19.1	15.0	9.1	5.1	4500 (310)
3/8	9/16-18	FNPT6-TA-OST9-	35.3	23.8	15.0	9.9	7.1	4500 (310)
1/2	3/4-16	FNPT8-TA-OST12-	44.7	27.0	19.8	11.2	10.7	4500 (310)
3/4	1 1/16-12	FNPT12-TA-OST17-	50.5	34.9	20.6	15.0	16.7	3600 (248)
1	1 5/16-12	FNPT16-TA-OST21-	53.8	41.3	25.4	15.0	22.4	2900 (199)

Внутренняя цилиндрическая резьба ISO

Внешняя резьба NPT

P-BG Размер	Px-NPT Размер	Артикул для заказа	Размеры, мм					Рабочее давление, фунт/кв. дюйм (бар) Нерж. сталь 316
			L	F	B	Bx	E	
1/8	1/8	FBP2-TA-NPT2-	21.8	14.3	6.5	9.7	4.8	6100 (420)
1/4	1/4	FBP4-TA-NPT4-	30.2	19.1	12.9	14.2	5.6	5700 (392)
3/8	3/8	FBP6-TA-NPT6-	32.2	23.8	14.2	14.2	6.6	5700 (392)
1/2	1/2	FBP8-TA-NPT8-	42.7	27.0	18.8	19.1	7.1	3900 (268)

Угольник с внешней резьбой

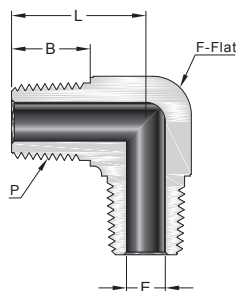

Внешняя резьба NPT

P-NPT P размер	Артикул для заказа	Размеры, мм				Рабочее давление, фунт/кв. дюйм (бар)	
		L	F	B	E	Нерж. сталь 316	Латунь
1/16	NPT1-TME-NPT1-	15.5	9.5	9.7	3.0	11000 (757)	5500 (378)
1/8	NPT2-TME-NPT2-	22.4	11.1	9.7	4.8	10000 (689)	5000 (344)
1/4	NPT4-TME-NPT4-	26.7	12.7	14.2	7.1	8000 (551)	4000 (275)
3/8	NPT6-TME-NPT6-	29.7	17.5	14.2	9.6	7800 (537)	3900 (268)
1/2	NPT8-TME-NPT8-	36.8	20.6	19.1	11.9	7700 (530)	3800 (261)
3/4	NPT12-TME-NPT12-	40.4	27.0	19.1	15.7	7300 (502)	3600 (248)
1	NPT16-TME-NPT16-	50.0	34.9	23.9	22.4	5300 (365)	2600 (179)

Внешняя коническая трубная резьба ISO

P-BSPT Размер	Артикул для заказа	Размеры, мм				Рабочее давление, фунт/кв. дюйм (бар)	
		L	F	B	E	Нерж. сталь 316	Латунь
1/16	MBT1-TME-MBT1-	15.5	9.5	9.7	3.0	11000 (757)	5500 (378)
1/8	MBT2-TME-MBT2-	22.4	11.1	9.7	4.8	10000 (689)	5000 (344)
1/4	MBT4-TME-MBT4-	26.7	12.7	14.2	7.1	8000 (551)	4000 (275)
3/8	MBT6-TME-MBT6-	29.7	17.5	14.2	9.6	7800 (537)	3900 (268)
1/2	MBT8-TME-MBT8-	36.8	20.6	19.1	11.9	7700 (530)	3800 (261)
3/4	MBT12-TME-MBT12-	40.4	27.0	19.1	15.7	7300 (502)	3600 (248)
1	MBT16-TME-MBT16-	50.0	34.9	23.9	22.4	5300 (365)	2600 (179)

Угольник с внутренней и внешней резьбой

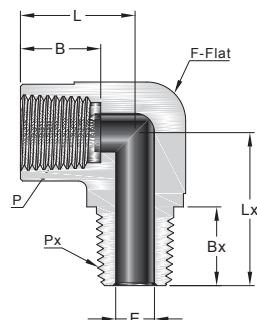

Внутренняя резьба NPT

Внешняя резьба NPT

P-NPT Размер	Px-NPT Размер	Артикул для заказа	Размеры, мм						Рабочее давление, фунт/кв. дюйм (бар)	
			L	F	B	E	Lx	Bx	Нерж. сталь 316	Латунь
1/16	1/16	FNPT1-TSE-NPT1-	21.8	11.1	9.9	3.0	22.4	9.7	9200 (633)	4600 (316)
1/16	1/8	FNPT1-TSE-NPT2-	21.8	11.1	9.9	4.8	22.4	9.7	9200 (633)	4600 (316)
1/16	1/4	FNPT1-TSE-NPT4-	22.4	14.3	9.9	4.8	27.7	14.2	8000 (551)	4000 (275)
1/16	3/8	FNPT1-TSE-NPT6-	22.4	17.5	9.9	4.8	29.7	14.2	7800 (537)	3900 (268)
1/8	1/16	FNPT2-TSE-NPT1-	26.4	12.7	10.4	3.0	22.1	9.7	6200 (426)	3100 (213)
1/8	1/8	FNPT2-TSE-NPT2-	26.4	12.7	10.4	4.8	22.1	9.7	6200 (426)	3100 (213)
1/8	1/4	FNPT2-TSE-NPT4-	22.4	14.3	10.4	7.1	27.7	14.2	6500 (447)	3200 (220)
1/8	3/8	FNPT2-TSE-NPT6-	22.4	17.5	10.4	7.1	29.7	14.2	7800 (537)	3900 (268)
1/8	1/2	FNPT2-TSE-NPT8-	24.1	20.6	10.4	7.1	36.8	19.1	7700 (530)	3800 (261)
1/8	3/4	FNPT2-TSE-NPT12-	25.4	27.0	10.4	7.1	40.4	19.1	7300 (502)	3600 (248)
1/8	1	FNPT2-TSE-NPT16-	26.4	34.9	10.4	7.1	50.0	23.9	5300 (365)	2600 (179)
1/4	1/8	FNPT4-TSE-NPT2-	29.7	17.5	15.0	4.8	25.4	9.7	7200 (496)	3600 (248)
1/4	1/4	FNPT4-TSE-NPT4-	29.7	17.5	15.0	7.1	29.7	14.2	7200 (496)	3600 (248)
1/4	3/8	FNPT4-TSE-NPT6-	29.7	17.5	15.0	8.6	29.7	14.2	7200 (496)	3600 (248)
1/4	1/2	FNPT4-TSE-NPT8-	25.4	20.6	15.0	8.6	36.8	19.1	7200 (496)	3600 (248)
1/4	3/4	FNPT4-TSE-NPT12-	25.4	27.0	15.0	8.6	40.4	19.1	7300 (502)	3600 (248)
1/4	1	FNPT4-TSE-NPT16-	41.4	34.9	15.0	8.6	50.0	23.9	5300 (365)	2600 (179)
3/8	1/4	FNPT6-TSE-NPT4-	36.1	20.6	15.0	7.1	32.0	14.2	5600 (385)	2800 (192)
3/8	3/8	FNPT6-TSE-NPT6-	36.1	20.6	15.0	9.6	32.0	14.2	5600 (385)	2800 (192)
3/8	1/2	FNPT6-TSE-NPT8-	36.1	20.6	15.0	11.9	36.8	19.1	5600 (385)	2800 (192)
3/8	3/4	FNPT6-TSE-NPT12-	31.2	27.0	15.0	11.9	40.4	19.1	7300 (502)	3600 (248)
3/8	1	FNPT6-TSE-NPT16-	41.4	34.9	15.0	11.9	50.0	23.9	5300 (365)	2600 (179)
1/2	1/4	FNPT8-TSE-NPT4-	39.6	25.4	19.8	7.1	35.1	14.2	5600 (385)	2800 (192)
1/2	3/8	FNPT8-TSE-NPT6-	39.6	25.4	19.8	9.6	35.1	14.2	5600 (385)	2800 (192)
1/2	1/2	FNPT8-TSE-NPT8-	39.6	25.4	19.8	11.9	39.6	19.1	5600 (385)	2800 (192)
1/2	3/4	FNPT8-TSE-NPT12-	31.2	27.0	19.8	15.7	40.4	19.1	5600 (385)	2800 (192)
1/2	1	FNPT8-TSE-NPT16-	41.4	34.9	19.8	15.7	50.0	23.9	5300 (365)	2600 (179)
3/4	3/4	FNPT12-TSE-NPT12-	48.8	31.8	20.6	15.7	42.4	19.1	5100 (351)	2500 (172)
3/4	1	FNPT12-TSE-NPT16-	41.4	34.9	20.6	22.4	50.0	23.9	5100 (351)	2500 (172)
1	1	FNPT16-TSE-NPT16-	48.5	42.9	25.4	22.4	49.3	23.9	5300 (365)	2600 (179)
1 1/4	1 1/4	FNPT20-TSE-NPT20-	60.5	50.8	25.4	31.8	60.5	23.9	3100 (213)	1600 (110)

Угольник с внутренней и внешней резьбой

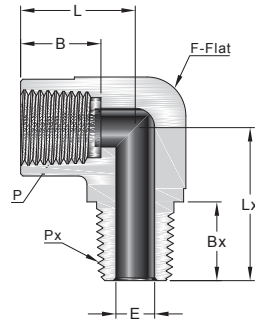

Внутренняя коническая резьба трубы ISO

Внешняя коническая резьба ISO

P-BSPT Размер	Px-BSPT Размер	Артикул для заказа	Размеры, мм						Рабочее давление, фунт/кв. дюйм (бар)	
			L	F	B	E	Lx	Bx	Нерж. сталь 316	Латунь
1/16	1/16	FBT1-TSE-MBT1-	21.8	11.1	9.9	3.0	22.4	9.7	9200 (633)	4600 (316)
1/16	1/8	FBT1-TSE-MBT2-	21.8	11.1	9.9	4.8	22.4	9.7	9200 (633)	4600 (316)
1/16	1/4	FBT1-TSE-MBT4-	22.4	14.3	9.9	4.8	27.7	14.2	8000 (551)	4000 (275)
1/16	3/8	FBT1-TSE-MBT6-	22.4	17.5	9.9	4.8	29.7	14.2	7800 (537)	3900 (268)
1/8	1/16	FBT2-TSE-MBT1-	26.4	12.7	10.4	3.0	22.1	9.7	6200 (426)	3100 (213)
1/8	1/8	FBT2-TSE-MBT2-	26.4	12.7	10.4	4.8	22.1	9.7	6200 (426)	3100 (213)
1/8	1/4	FBT2-TSE-MBT4-	22.4	14.3	10.4	7.1	27.7	14.2	6500 (447)	3200 (220)
1/8	3/8	FBT2-TSE-MBT6-	22.4	17.5	10.4	7.1	29.7	14.2	7800 (537)	3900 (268)
1/8	1/2	FBT2-TSE-MBT8-	24.1	20.6	10.4	7.1	36.8	19.1	7700 (530)	3800 (261)
1/8	3/4	FBT2-TSE-MBT12-	25.4	27.0	10.4	7.1	40.4	19.1	7300 (502)	3600 (248)
1/8	1	FBT2-TSE-MBT16-	26.4	34.9	10.4	7.1	50.0	23.9	5300 (365)	2600 (179)
1/4	1/8	FBT4-TSE-MBT2-	29.7	17.5	15.0	4.8	25.4	9.7	7200 (496)	3600 (248)
1/4	1/4	FBT4-TSE-MBT4-	29.7	17.5	15.0	7.1	29.7	14.2	7200 (496)	3600 (248)
1/4	3/8	FBT4-TSE-MBT6-	29.7	17.5	15.0	8.6	29.7	14.2	7200 (496)	3600 (248)
1/4	1/2	FBT4-TSE-MBT8-	25.4	20.6	15.0	8.6	36.8	19.1	7200 (496)	3600 (248)
1/4	3/4	FBT4-TSE-MBT12-	25.4	27.0	15.0	8.6	40.4	19.1	7300 (502)	3600 (248)
1/4	1	FBT4-TSE-MBT16-	41.4	34.9	15.0	8.6	50.0	23.9	5300 (365)	2600 (179)
3/8	1/4	FBT6-TSE-MBT4-	36.1	20.6	15.0	7.1	32.0	14.2	5600 (385)	2800 (192)
3/8	3/8	FBT6-TSE-MBT6-	36.1	20.6	15.0	9.6	32.0	14.2	5600 (385)	2800 (192)
3/8	1/2	FBT6-TSE-MBT8-	36.1	20.6	15.0	11.9	36.8	19.1	5600 (385)	2800 (192)
3/8	3/4	FBT6-TSE-MBT12-	31.2	27.0	15.0	11.9	40.4	19.1	7300 (502)	3600 (248)
3/8	1	FBT6-TSE-MBT16-	41.4	34.9	15.0	11.9	50.0	23.9	5300 (365)	2600 (179)
1/2	1/4	FBT8-TSE-MBT4-	39.6	25.4	19.8	7.1	35.1	14.2	5600 (385)	2800 (192)
1/2	3/8	FBT8-TSE-MBT6-	39.6	25.4	19.8	9.6	35.1	14.2	5600 (385)	2800 (192)
1/2	1/2	FBT8-TSE-MBT8-	39.6	25.4	19.8	11.9	39.6	19.1	5600 (385)	2800 (192)
1/2	3/4	FBT8-TSE-MBT12-	31.2	27.0	19.8	15.7	40.4	19.1	5600 (385)	2800 (192)
1/2	1	FBT8-TSE-MBT16-	41.4	34.9	19.8	15.7	50.0	23.9	5300 (365)	2600 (179)
3/4	3/4	FBT12-TSE-MBT12-	48.8	31.8	20.6	15.7	42.4	19.1	5100 (351)	2500 (172)
3/4	1	FBT12-TSE-MBT16-	41.4	34.9	20.6	22.4	50.0	23.9	5100 (351)	2500 (172)
1	1	FBT16-TSE-MBT16-	48.5	42.9	25.4	22.4	49.3	23.9	5300 (365)	2600 (179)
1 1/4	1 1/4	FBT20-TSE-MBT20-	60.5	50.8	25.4	31.8	60.5	23.9	3100 (213)	1600 (110)

Угольник с внутренней и внешней резьбой под 45°

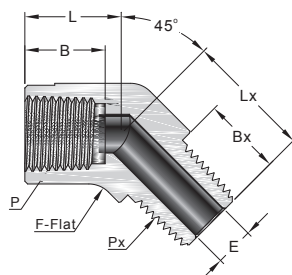

Внутренняя резьба NPT

Внешняя резьба NPT

P-NPT Размер	Px-NPT Размер	Артикул для заказа	Размеры, мм						Рабочее давление, фунт/кв. дюйм (бар)	
			L	F	B	E	Lx	Bx	Нерж. сталь 316	Латунь
1/16	1/16	FNPT1-T45E-NPT1-	16.8	11.1	9.9	3.0	16.8	9.7	9200 (633)	4600 (316)
1/16	1/8	FNPT1-T45E-NPT2-	16.8	11.1	9.9	4.8	16.8	9.7	9200 (633)	4600 (316)
1/16	1/4	FNPT1-T45E-NPT4-	16.8	14.3	9.9	4.8	21.8	14.2	8000 (551)	4000 (275)
1/16	3/8	FNPT1-T45E-NPT6-	22.4	17.5	9.9	4.8	23.8	14.2	7800 (537)	3900 (268)
1/8	1/16	FNPT2-T45E-NPT1-	20.2	12.7	10.4	3.0	17.2	9.7	6200 (426)	3100 (213)
1/8	1/8	FNPT2-T45E-NPT2-	20.2	12.7	10.4	4.8	17.2	9.7	6200 (426)	3100 (213)
1/8	1/4	FNPT2-T45E-NPT4-	16.8	14.3	10.4	7.1	21.8	14.2	6500 (447)	3200 (220)
1/8	3/8	FNPT2-T45E-NPT6-	22.4	17.5	10.4	7.1	23.8	14.2	7800 (537)	3900 (268)
1/8	1/2	FNPT2-T45E-NPT8-	22.2	20.6	10.4	7.1	29.0	19.1	7700 (530)	3800 (261)
1/8	3/4	FNPT2-T45E-NPT12-	25.4	27.0	10.4	7.1	30.5	19.1	7300 (502)	3600 (248)
1/8	1	FNPT2-T45E-NPT16-	26.4	34.9	10.4	7.1	49.3	23.9	5300 (365)	2600 (179)
1/4	1/8	FNPT4-T45E-NPT2-	25.4	17.5	15.0	4.8	19.3	9.7	7200 (496)	3600 (248)
1/4	1/4	FNPT4-T45E-NPT4-	25.4	17.5	15.0	7.1	19.3	14.2	7200 (496)	3600 (248)
1/4	3/8	FNPT4-T45E-NPT6-	25.4	17.5	15.0	8.6	23.8	14.2	7200 (496)	3600 (248)
1/4	1/2	FNPT4-T45E-NPT8-	22.2	20.6	15.0	8.6	29.0	19.1	7200 (496)	3600 (248)
1/4	3/4	FNPT4-T45E-NPT12-	25.4	27.0	15.0	8.6	30.5	19.1	7300 (502)	3600 (248)
1/4	1	FNPT4-T45E-NPT16-	32.0	34.9	15.0	8.6	37.6	23.9	5300 (365)	2600 (179)
3/8	1/4	FNPT6-T45E-NPT4-	27.0	20.6	15.0	7.1	24.2	14.2	5600 (385)	2800 (192)
3/8	3/8	FNPT6-T45E-NPT6-	27.0	20.6	15.0	9.6	24.2	14.2	5600 (385)	2800 (192)
3/8	1/2	FNPT6-T45E-NPT8-	27.0	20.6	15.0	11.9	29.0	19.1	5600 (385)	2800 (192)
3/8	3/4	FNPT6-T45E-NPT12-	27.0	27.0	15.0	11.9	30.5	19.1	7300 (502)	3600 (248)
3/8	1	FNPT6-T45E-NPT16-	32.0	34.9	15.0	11.9	37.6	23.9	5300 (365)	2600 (179)
1/2	1/4	FNPT8-T45E-NPT4-	32.0	25.4	19.8	7.1	25.2	14.2	5600 (385)	2800 (192)
1/2	3/8	FNPT8-T45E-NPT6-	32.0	25.4	19.8	9.6	25.2	14.2	5600 (385)	2800 (192)
1/2	1/2	FNPT8-T45E-NPT8-	32.0	25.4	19.8	11.9	32.0	19.1	5600 (385)	2800 (192)
1/2	3/4	FNPT8-T45E-NPT12-	32.5	27.0	19.8	15.7	30.5	19.1	5600 (385)	2800 (192)
1/2	1	FNPT8-T45E-NPT16-	37.6	34.9	19.8	15.7	37.6	23.9	5300 (365)	2600 (179)
3/4	3/4	FNPT12-T45E-NPT12-	34.5	31.8	20.6	15.7	34.5	19.1	5100 (351)	2500 (172)
3/4	1	FNPT12-T45E-NPT16-	37.6	34.9	20.6	22.4	37.6	23.9	5100 (351)	2500 (172)
1	1	FNPT16-T45E-NPT16-	46.0	42.9	25.4	22.4	46.0	23.9	5300 (365)	2600 (179)
1 1/4	1 1/4	FNPT20-T45E-NPT20-	50.8	50.8	25.4	31.8	50.8	23.9	3100 (213)	1600 (110)

Угольник с внутренней и внешней резьбой под 45°

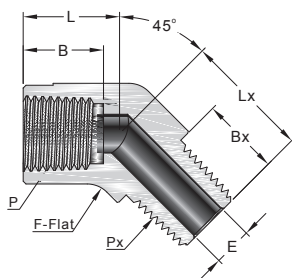

Внутренняя коническая резьба ISO

Внешняя коническая резьба ISO

P-BSPT Размер	Px-BSPT Размер	Артикул для заказа	Размеры, мм						Рабочее давление, фунт/кв. дюйм (бар)	
			L	F	B	E	Lx	Bx	Нерж. сталь 316	Латунь
1/16	1/16	FBT1-T45E-MBT1-	16.8	11.1	9.9	3.0	16.8	9.7	9200 (633)	4600 (316)
1/16	1/8	FBT1-T45E-MBT2-	16.8	11.1	9.9	4.8	16.8	9.7	9200 (633)	4600 (316)
1/16	1/4	FBT1-T45E-MBT4-	16.8	14.3	9.9	4.8	21.8	14.2	8000 (551)	4000 (275)
1/16	3/8	FBT1-T45E-MBT6-	22.4	17.5	9.9	4.8	23.8	14.2	7800 (537)	3900 (268)
1/8	1/16	FBT2-T45E-MBT1-	20.2	12.7	10.4	3.0	17.2	9.7	6200 (426)	3100 (213)
1/8	1/8	FBT2-T45E-MBT2-	20.2	12.7	10.4	4.8	17.2	9.7	6200 (426)	3100 (213)
1/8	1/4	FBT2-T45E-MBT4-	16.8	14.3	10.4	7.1	21.8	14.2	6500 (447)	3200 (220)
1/8	3/8	FBT2-T45E-MBT6-	22.4	17.5	10.4	7.1	23.8	14.2	7800 (537)	3900 (268)
1/8	1/2	FBT2-T45E-MBT8-	22.2	20.6	10.4	7.1	29.0	19.1	7700 (530)	3800 (261)
1/8	3/4	FBT2-T45E-MBT12-	25.4	27.0	10.4	7.1	30.5	19.1	7300 (502)	3600 (248)
1/8	1	FBT2-T45E-MBT16-	26.4	34.9	10.4	7.1	49.3	23.9	5300 (365)	2600 (179)
1/4	1/8	FBT4-T45E-MBT2-	25.4	17.5	15.0	4.8	19.3	9.7	7200 (496)	3600 (248)
1/4	1/4	FBT4-T45E-MBT4-	25.4	17.5	15.0	7.1	19.3	14.2	7200 (496)	3600 (248)
1/4	3/8	FBT4-T45E-MBT6-	25.4	17.5	15.0	8.6	23.8	14.2	7200 (496)	3600 (248)
1/4	1/2	FBT4-T45E-MBT8-	22.2	20.6	15.0	8.6	29.0	19.1	7200 (496)	3600 (248)
1/4	3/4	FBT4-T45E-MBT12-	25.4	27.0	15.0	8.6	30.5	19.1	7300 (502)	3600 (248)
1/4	1	FBT4-T45E-MBT16-	32.0	34.9	15.0	8.6	37.6	23.9	5300 (365)	2600 (179)
3/8	1/4	FBT6-T45E-MBT4-	27.0	20.6	15.0	7.1	24.2	14.2	5600 (385)	2800 (192)
3/8	3/8	FBT6-T45E-MBT6-	27.0	20.6	15.0	9.6	24.2	14.2	5600 (385)	2800 (192)
3/8	1/2	FBT6-T45E-MBT8-	27.0	20.6	15.0	11.9	29.0	19.1	5600 (385)	2800 (192)
3/8	3/4	FBT6-T45E-MBT12-	27.0	27.0	15.0	11.9	30.5	19.1	7300 (502)	3600 (248)
3/8	1	FBT6-T45E-MBT16-	32.0	34.9	15.0	11.9	37.6	23.9	5300 (365)	2600 (179)
1/2	1/4	FBT8-T45E-MBT4-	32.0	25.4	19.8	7.1	25.2	14.2	5600 (385)	2800 (192)
1/2	3/8	FBT8-T45E-MBT6-	32.0	25.4	19.8	9.6	25.2	14.2	5600 (385)	2800 (192)
1/2	1/2	FBT8-T45E-MBT8-	32.0	25.4	19.8	11.9	32.0	19.1	5600 (385)	2800 (192)
1/2	3/4	FBT8-T45E-MBT12-	32.5	27.0	19.8	15.7	30.5	19.1	5600 (385)	2800 (192)
1/2	1	FBT8-T45E-MBT16-	37.6	34.9	19.8	15.7	37.6	23.9	5300 (365)	2600 (179)
3/4	3/4	FBT12-T45E-MBT12-	34.5	31.8	20.6	15.7	34.5	19.1	5100 (351)	2500 (172)
3/4	1	FBT12-T45E-MBT16-	37.6	34.9	20.6	22.4	37.6	23.9	5100 (351)	2500 (172)
1	1	FBT16-T45E-MBT16-	46.0	42.9	25.4	22.4	46.0	23.9	5300 (365)	2600 (179)
1 1/4	1 1/4	FBT20-T45E-MBT20-	50.8	50.8	25.4	31.8	50.8	23.9	3100 (213)	1600 (110)

Угольник с внутренней резьбой

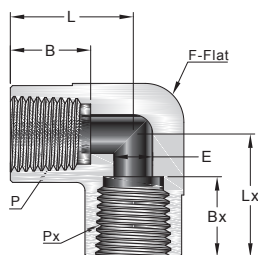

Внутренняя резьба FNPT

P-FNPT Размер	Px-FNPT Размер	Артикул для заказа	Размеры, мм						Рабочее давление, фунт/кв. дюйм (бар)	
			L	F	B	E	Lx	Bx	Нерж. сталь 316	Латунь
1/16	1/16	FNPT1-TFE-FNPT1-	21.8	11.1	9.9	4.8	21.8	9.9	6700 (460)	3300 (227)
1/8	1/16	FNPT2-TFE-FNPT1-	26.4	12.7	10.4	4.8	26.4	9.9	6200 (427)	3100 (213)
1/8	1/8	FNPT2-TFE-FNPT2-	26.4	12.7	10.4	8.6	26.4	10.4	6200 (427)	3100 (213)
1/4	1/8	FNPT4-TFE-FNPT2-	29.7	17.5	15.0	7.1	29.7	10.4	7200 (496)	3600 (248)
1/4	1/4	FNPT4-TFE-FNPT4-	29.7	17.5	15.0	11.4	29.7	15.0	7200 (496)	3600 (248)
3/8	3/8	FNPT6-TFE-FNPT6-	36.1	20.6	15.0	15.0	36.1	15.0	5600 (385)	2800 (192)
1/2	1/2	FNPT8-TFE-FNPT8-	39.6	25.4	19.8	18.5	39.6	19.8	5600 (385)	2800 (192)
3/4	3/4	FNPT12-TFE-FNPT12-	48.8	31.8	20.6	23.9	48.8	20.6	5100 (351)	2500 (172)
1	1	FNPT16-TFE-FNPT16-	48.5	42.9	25.4	29.7	48.5	25.4	6400 (440)	3200 (220)
1 1/4	1 1/4	FNPT20-TFE-FNPT20-	59.8	50.8	25.4	27.7	50.8	25.4	3100 (213)	1600 (110)
1 1/2	1 1/2	FNPT24-TFE-FNPT24-	65.0	63.5	27.7	34.0	52.8	27.7	5100 (351)	2500 (172)
Толстостенные nipples с внутренней резьбой NPT										
1/4	1/4	FNPT4-TFE1-FNPT4-	39.6	25.4	15.0	11.4	29.7	15.0	10000 (689)	—
1/2	1/2	FNPT8-TFE1-FNPT8-	50.0	42.9	19.8	18.5	39.6	19.8	10000 (689)	—

Внутренняя коническая резьба ISO

P-BSPT Размер	Px-BSPT Размер	Артикул для заказа	Размеры, мм						Рабочее давление, фунт/кв. дюйм (бар)	
			L	F	B	E	Lx	Bx	Нерж. сталь 316	Латунь
1/16	1/16	FBT1-TFE-FBT1-	21.8	11.1	9.9	4.8	21.6	9.9	6700 (460)	3300 (227)
1/8	1/16	FBT2-TFE-FBT1-	16.8	12.7	10.4	4.8	16.8	9.9	6200 (427)	3100 (213)
1/8	1/8	FBT2-TFE-FBT2-	26.4	12.7	10.4	7.1	26.4	10.4	6200 (427)	3100 (213)
1/4	1/8	FBT4-TFE-FBT2-	29.7	17.5	15.0	7.1	29.7	10.4	7200 (496)	3600 (248)
1/4	1/4	FBT4-TFE-FBT4-	29.7	17.5	15.0	10.4	29.7	15.0	7200 (496)	3600 (248)
3/8	3/8	FBT6-TFE-FBT6-	36.1	20.6	15.0	12.7	36.1	15.0	5600 (385)	2800 (192)
1/2	1/2	FBT8-TFE-FBT8-	39.6	25.4	19.8	15.7	39.6	19.8	5600 (385)	2800 (192)
3/4	3/4	FBT12-TFE-FBT12-	48.8	31.8	20.6	22.4	48.8	20.6	5100 (351)	2500 (172)
1	1	FBT16-TFE-FBT16-	48.5	42.9	25.4	22.4	48.5	25.4	6400 (440)	3200 (220)
1 1/4	1 1/4	FBT20-TFE-FBT20-	59.8	50.8	25.4	27.7	50.8	25.4	3100 (213)	1600 (110)
1 1/2	1 1/2	FBT24-TFE-FBT24-	65.0	63.5	27.7	34.0	52.8	27.7	5100 (351)	2500 (172)

Угольник под 45° с внутренней резьбой

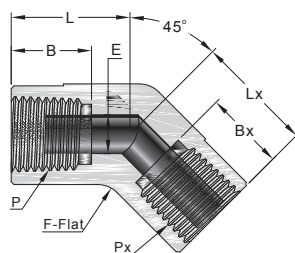

Внутренняя резьба NPT

P-FNPT Размер	Px-FNPT Размер	Артикул для заказа	Размеры, мм						Рабочее давление, фунт/кв. дюйм (бар)	
			L	F	B	E	Lx	Bx	Нерж. сталь 316	Латунь
1/16	1/16	FNPT1-T45FE-FNPT1-	16.8	11.1	9.9	4.8	16.8	9.9	6700 (460)	3300 (227)
1/8	1/16	FNPT2-T45FE-FNPT1-	20.2	12.7	10.4	4.8	20.2	9.9	6200 (427)	3100 (213)
1/8	1/8	FNPT2-T45FE-FNPT2-	20.2	12.7	10.4	7.1	20.2	10.4	6200 (427)	3100 (213)
1/4	1/8	FNPT4-T45FE-FNPT2-	25.4	17.5	15.0	7.1	25.4	10.4	7200 (496)	3600 (248)
1/4	1/4	FNPT4-T45FE-FNPT4-	25.4	17.5	15.0	10.4	25.4	15.0	7200 (496)	3600 (248)
3/8	3/8	FNPT6-T45FE-FNPT6-	27.0	20.6	15.0	12.7	27.0	15.0	5600 (385)	2800 (192)
1/2	1/2	FNPT8-T45FE-FNPT8-	32.0	25.4	19.8	15.7	32.0	19.8	5600 (385)	2800 (192)
3/4	3/4	FNPT12-T45FE-FNPT12-	34.5	31.8	20.6	22.4	34.5	20.6	5100 (351)	2500 (172)
1	1	FNPT16-T45FE-FNPT16-	46.0	42.9	25.4	22.4	46.0	25.4	6400 (440)	3200 (220)
1 1/4	1 1/4	FNPT20-T45FE-FNPT20-	43.2	50.8	25.4	27.7	43.2	25.4	3100 (213)	1600 (110)
1 1/2	1 1/2	FNPT24-T45FE-FNPT24-	46.0	63.5	27.7	34.0	46.0	27.7	5100 (351)	2500 (172)

Внутренняя коническая резьба трубы ISO

P-BSPT Размер	Px-BSPT Размер	Артикул для заказа	Размеры, мм						Рабочее давление, фунт/кв. дюйм (бар)	
			L	F	B	E	Lx	Bx	Нерж. сталь 316	Латунь
1/16	1/16	FBT1-T45FE-FBT1-	16.8	11.1	9.9	4.8	16.8	9.9	6700 (460)	3300 (227)
1/8	1/16	FBT2-T45FE-FBT1-	20.2	12.7	10.4	4.8	20.2	9.9	6200 (427)	3100 (213)
1/8	1/8	FBT2-T45FE-FBT2-	20.2	12.7	10.4	7.1	20.2	10.4	6200 (427)	3100 (213)
1/4	1/8	FBT4-T45FE-FBT2-	25.4	17.5	15.0	7.1	25.4	10.4	7200 (496)	3600 (248)
1/4	1/4	FBT4-T45FE-FBT4-	25.4	17.5	15.0	10.4	25.4	15.0	7200 (496)	3600 (248)
3/8	3/8	FBT6-T45FE-FBT6-	27.0	20.6	15.0	12.7	27.0	15.0	5600 (385)	2800 (192)
1/2	1/2	FBT8-T45FE-FBT8-	32.0	25.4	19.8	15.7	32.0	19.8	5600 (385)	2800 (192)
3/4	3/4	FBT12-T45FE-FBT12-	34.5	31.8	20.6	22.4	34.5	20.6	5100 (351)	2500 (172)
1	1	FBT16-T45FE-FBT16-	46.0	42.9	25.4	22.4	46.0	25.4	6400 (440)	3200 (220)
1 1/4	1 1/4	FBT20-T45FE-FBT20-	43.2	50.8	25.4	27.7	43.2	25.4	3100 (213)	1600 (110)
1 1/2	1 1/2	FBT24-T45FE-FBT24-	46.0	63.5	27.7	34.0	46.0	27.7	5100 (351)	2500 (172)

Тройник с внешней резьбой

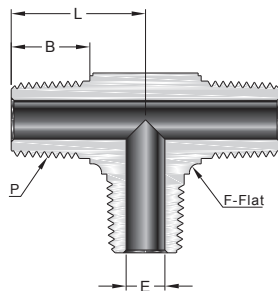

Внешняя резьба NPT

P-NPT Размер	Артикул для заказа	Размеры, мм				Рабочее давление, фунт/кв. дюйм (бар)	
		L	F	B	E	Нерж. сталь 316	Латунь
1/16	NPT1-TMT-NPT1-NPT1-	15.5	9.5	9.7	3.0	11000 (757)	5500 (378)
1/8	NPT2-TMT-NPT2-NPT2-	22.4	11.1	9.7	4.8	10000 (689)	5000 (344)
1/4	NPT4-TMT-NPT4-NPT4-	26.7	12.7	14.2	7.1	8000 (551)	4000 (275)
3/8	NPT6-TMT-NPT6-NPT6-	29.7	17.5	14.2	9.6	7800 (537)	3900 (268)
1/2	NPT8-TMT-NPT8-NPT8-	36.8	20.6	19.1	11.9	7700 (530)	3800 (261)
3/4	NPT12-TMT-NPT12-NPT12-	42.4	27.0	19.1	15.7	7300 (502)	3600 (248)
1	NPT16-TMT-NPT16-NPT16-	49.3	34.9	23.9	22.4	5300 (365)	2600 (179)
1 1/4	NPT20-TMT-NPT20-NPT20-	56.4	42.9	23.9	27.7	6000 (410)	3000 (200)
1 1/2	NPT24-TMT-NPT24-NPT24-	67.1	47.6	26.2	34.0	5000 (344)	2500 (172)

Внешняя коническая резьба ISO

P-BSPT Размер	Артикул для заказа	Размеры, мм				Рабочее давление, фунт/кв. дюйм (бар)	
		L	F	B	E	Нерж. сталь 316	Латунь
1/16	MBT1-TMT-MBT1-MBT1-	15.5	9.5	9.7	3.0	11000 (757)	5500 (378)
1/8	MBT2-TMT-MBT2-MBT2-	22.4	11.1	9.7	4.8	10000 (689)	5000 (344)
1/4	MBT4-TMT-MBT4-MBT4-	26.7	12.7	14.2	7.1	8000 (551)	4000 (275)
3/8	MBT6-TMT-MBT6-MBT6-	29.7	17.5	14.2	9.6	7800 (537)	3900 (268)
1/2	MBT8-TMT-MBT8-MBT8-	36.8	20.6	19.1	11.9	7700 (530)	3800 (261)
3/4	MBT12-TMT-MBT12-MBT12-	42.4	27.0	19.1	15.7	7300 (502)	3600 (248)
1	MBT16-TMT-MBT16-MBT16-	49.3	34.9	23.9	22.4	5300 (365)	2600 (179)
1 1/4	MBT20-TMT-MBT20-MBT20-	56.4	42.9	23.9	27.7	6000 (410)	3000 (200)
1 1/2	MBT24-TMT-MBT24-MBT24-	67.1	47.6	26.2	34.0	5000 (344)	2500 (172)

Тройник с внешними резьбами и внутренней резьбой снизу

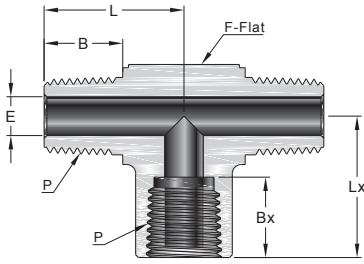

Резьба NPT

P-NPT Размер	Артикул для заказа	Размеры, мм						Рабочее давление, фунт/кв. дюйм (бар)	
		L	F	E	B	Lx	Bx	Нерж. сталь 316	Латунь
1/16	NPT1-TFBT-NPT1-FNPT1-	18.3	11.1	3.0	9.7	21.8	9.9	9200 (633)	4600 (316)
1/8	NPT2-TFBT-NPT2-FNPT2-	22.1	12.7	4.8	9.7	26.4	10.4	6200 (427)	3100 (213)
1/4	NPT4-TFBT-NPT4-FNPT4-	29.7	17.5	7.1	14.2	29.7	15.0	7200 (496)	3600 (248)
3/8	NPT6-TFBT-NPT6-FNPT6-	32.0	20.6	9.6	14.2	36.1	15.0	5600 (385)	2800 (192)
1/2	NPT8-TFBT-NPT8-FNPT8-	39.6	25.4	11.9	19.1	39.6	19.8	5600 (385)	2800 (192)
3/4	NPT12-TFBT-NPT12-FNPT12-	42.4	31.8	15.7	19.1	48.8	20.6	5100 (351)	2500 (172)
1	NPT16-TFBT-NPT16-FNPT16-	49.3	42.9	22.4	23.9	48.5	25.4	5300 (365)	2600 (179)

Коническая резьба трубы ISO

P-BSPT Размер	Артикул для заказа	Размеры, мм						Рабочее давление, фунт/кв. дюйм (бар)	
		L	F	E	B	Lx	Bx	Нерж. сталь 316	Латунь
1/16	MBT1-TFVT-MBT1-FBT1-	18.3	11.1	3.0	9.7	21.8	9.9	9200 (633)	4600 (316)
1/8	MBT2-TFVT-MBT2-FBT2-	22.1	12.7	4.8	9.7	26.4	10.4	6200 (427)	3100 (213)
1/4	MBT4-TFVT-MBT4-FBT4-	29.7	17.5	7.1	14.2	29.7	15.0	7200 (496)	3600 (248)
3/8	MBT6-TFVT-MBT6-FBT6-	32.0	20.6	9.6	14.2	36.1	15.0	5600 (385)	2800 (192)
1/2	MBT8-TFVT-MBT8-FBT8-	39.6	25.4	11.9	19.1	39.6	19.8	5600 (385)	2800 (192)
3/4	MBT12-TFVT-MBT12-FBT12-	42.4	31.8	15.7	19.1	48.8	20.6	5100 (351)	2500 (172)
1	MBT16-TFVT-MBT16-FBT16-	49.3	42.9	22.4	23.9	48.5	25.4	5300 (365)	2600 (179)

Тройник с внешними резьбами и внутренней резьбой сбоку

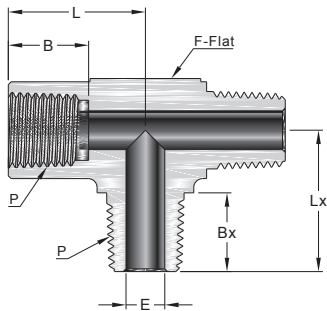

Резьба NPT

P-NPT Размер	Артикул для заказа	Размеры, мм						Рабочее давление, фунт/кв. дюйм (бар)	
		L	F	E	B	Lx	Bx	Нерж. сталь 316	Латунь
1/16	FNPT1-TFRT-NPT1-NPT1-	21.8	11.1	3.0	9.9	18.3	9.7	9200 (633)	4600 (316)
1/8	FNPT2-TFRT-NPT2-NPT2-	26.4	12.7	4.8	10.4	22.1	9.7	6200 (427)	3100 (213)
1/4	FNPT4-TFRT-NPT4-NPT4-	29.7	17.5	7.1	15.0	29.7	14.2	7200 (496)	3600 (248)
3/8	FNPT6-TFRT-NPT6-NPT6-	36.1	20.6	9.6	15.0	32.0	14.2	5600 (385)	2800 (192)
1/2	FNPT8-TFRT-NPT8-NPT8-	39.6	25.4	11.9	19.8	39.6	19.1	5600 (385)	2800 (192)
3/4	FNPT12-TFRT-NPT12-NPT12-	48.8	31.8	15.7	20.6	42.4	19.1	5100 (351)	2500 (172)
1	FNPT16-TFRT-NPT16-NPT16-	48.5	42.9	22.4	25.4	49.3	23.9	5300 (365)	2600 (179)

Коническая резьба ISO

P-BSPT Размер	Артикул для заказа	Размеры, мм						Рабочее давление, фунт/кв. дюйм (бар)	
		L	F	E	B	Lx	Bx	Нерж. сталь 316	Латунь
1/16	FBT1-TFRT-MBT1-MBT1-	21.8	11.1	3.0	9.9	18.3	9.7	9200 (633)	4600 (316)
1/8	FBT2-TFRT-MBT2-MBT2-	26.4	12.7	4.8	10.4	22.1	9.7	6200 (427)	3100 (213)
1/4	FBT4-TFRT-MBT4-MBT4-	29.7	17.5	7.1	15.0	29.7	14.2	7200 (496)	3600 (248)
3/8	FBT6-TFRT-MBT6-MBT6-	36.1	20.6	9.6	15.0	32.0	14.2	5600 (385)	2800 (192)
1/2	FBT8-TFRT-MBT8-MBT8-	39.6	25.4	11.9	19.8	39.6	19.1	5600 (385)	2800 (192)
3/4	FBT12-TFRT-MBT12-MBT12-	48.8	31.8	15.7	20.6	42.4	19.1	5100 (351)	2500 (172)
1	FBT16-TFRT-MBT16-MBT16-	48.5	42.9	22.4	25.4	49.3	23.9	5300 (365)	2600 (179)

Тройник с внутренними резьбами и внешней резьбой сбоку

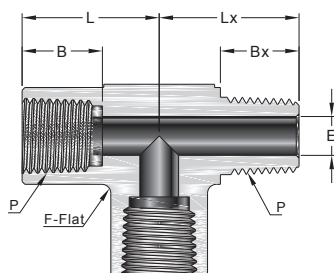

Резьба NPT

P-NPT Размер	Артикул для заказа	Размеры, мм						Рабочее давление, фунт/кв. дюйм (бар)	
		L	F	E	B	Lx	Bx	Нерж. сталь 316	Латунь
1/16	FNPT1-TMST-NPT1-FNPT1-	21.8	11.1	3.0	9.9	18.3	9.7	9200 (633)	4600 (316)
1/8	FNPT2-TMST-NPT2-FNPT2-	26.4	12.7	4.8	10.4	22.1	9.7	6200 (427)	3100 (213)
1/4	FNPT4-TMST-NPT4-FNPT4-	29.7	17.5	7.1	15.0	29.7	14.2	7200 (496)	3600 (248)
3/8	FNPT6-TMST-NPT6-FNPT6-	36.1	20.6	9.6	15.0	32.0	14.2	5600 (385)	2800 (192)
1/2	FNPT8-TMST-NPT8-FNPT8-	39.6	25.4	11.9	19.8	39.6	19.1	5600 (385)	2800 (192)
3/4	FNPT12-TMST-NPT12-FNPT12-	48.8	31.8	15.7	20.6	42.4	19.1	5100 (351)	2500 (172)
1	FNPT16-TMST-NPT16-FNPT16-	48.5	42.9	22.4	25.4	49.3	23.9	5300 (365)	2600 (179)

Коническая грубая резьба ISO

P-BSPT Размер	Артикул для заказа	Размеры, мм						Рабочее давление, фунт/кв. дюйм (бар)	
		L	F	E	B	Lx	Bx	Нерж. сталь 316	Латунь
1/16	FBT1-TMST-MBT1-FBT1-	21.8	11.1	3.0	9.9	18.3	9.7	9200 (633)	4600 (316)
1/8	FBT2-TMST-MBT2-FBT2-	26.4	12.7	4.8	10.4	22.1	9.7	6200 (427)	3100 (213)
1/4	FBT4-TMST-MBT4-FBT4-	29.7	17.5	7.1	15.0	29.7	14.2	7200 (496)	3600 (248)
3/8	FBT6-TMST-MBT6-FBT6-	36.1	20.6	9.6	15.0	32.0	14.2	5600 (385)	2800 (192)
1/2	FBT8-TMST-MBT8-FBT8-	39.6	25.4	11.9	19.8	39.6	19.1	5600 (385)	2800 (192)
3/4	FBT12-TMST-MBT12-FBT12-	48.8	31.8	15.7	20.6	42.4	19.1	5100 (351)	2500 (172)
1	FBT16-TMST-MBT16-FBT16-	48.5	42.9	22.4	25.4	49.3	23.9	5300 (365)	2600 (179)

Тройник с внутренними резьбами и внешней резьбой снизу

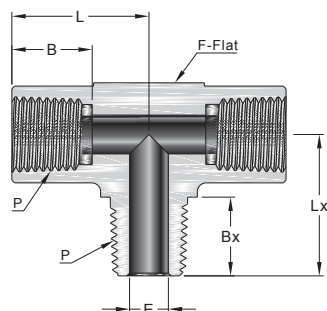

Резьба NPT

P-NPT Размер	Артикул для заказа	Размеры, мм						Рабочее давление, фунт/кв. дюйм (бар)	
		L	F	E	B	Lx	Bx	Нерж. сталь 316	Латунь
1/16	FNPT1-TMBT-FNPT1-NPT1-	21.8	11.1	3.0	9.9	18.3	9.7	9200 (633)	4600 (316)
1/8	FNPT2-TMBT-FNPT2-NPT2-	26.4	12.7	4.8	10.4	22.1	9.7	6200 (427)	3100 (213)
1/4	FNPT4-TMBT-FNPT4-NPT4-	29.7	17.5	7.1	15.0	29.7	14.2	7200 (496)	3600 (248)
3/8	FNPT6-TMBT-FNPT6-NPT6-	36.1	20.6	9.6	15.0	32.0	14.2	5600 (385)	2800 (192)
1/2	FNPT8-TMBT-FNPT8-NPT8-	39.6	25.4	11.9	19.8	39.6	19.1	5600 (385)	2800 (192)
3/4	FNPT12-TMBT-FNPT12-NPT12-	48.8	31.8	15.7	20.6	42.4	19.1	5100 (351)	2500 (172)
1	FNPT16-TMBT-FNPT16-NPT16-	48.5	42.9	22.4	25.4	49.3	23.9	5300 (365)	2600 (179)

Коническая трубная резьба ISO

P-BSPT Размер	Артикул для заказа	Размеры, мм						Рабочее давление, фунт/кв. дюйм (бар)	
		L	F	E	B	Lx	Bx	Нерж. сталь 316	Латунь
1/16	FBT1-TMBT-FBT1-MBT1-	21.8	11.1	3.0	9.9	18.3	9.7	9200 (633)	4600 (316)
1/8	FBT2-TMBT-FBT2-MBT2-	26.4	12.7	4.8	10.4	22.1	9.7	6200 (427)	3100 (213)
1/4	FBT4-TMBT-FBT4-MBT4-	29.7	17.5	7.1	15.0	29.7	14.2	7200 (496)	3600 (248)
3/8	FBT6-TMBT-FBT6-MBT6-	36.1	20.6	9.6	15.0	32.0	14.2	5600 (385)	2800 (192)
1/2	FBT8-TMBT-FBT8-MBT8-	39.6	25.4	11.9	19.8	39.6	19.1	5600 (385)	2800 (192)
3/4	FBT12-TMBT-FBT12-MBT12-	48.8	31.8	15.7	20.6	42.4	19.1	5100 (351)	2500 (172)
1	FBT16-TMBT-FBT16-MBT16-	48.5	42.9	22.4	25.4	49.3	23.9	5300 (365)	2600 (179)

Тройник с внутренней резьбой

Внутренняя резьба

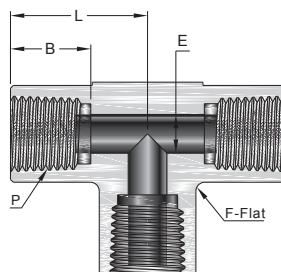

Внутренняя резьба NPT

P-NPT Размер	Артикул для заказа	Размеры, мм				Рабочее давление, фунт/кв. дюйм (бар)	
		L	F	E	B	Нерж. сталь 316	Латунь
1/16	FNPT1-TFT-FNPT1-FNPT1-	21.8	11.1	4.8	9.9	6700 (460)	3300 (227)
1/8	FNPT2-TFT-FNPT2-FNPT2-	26.4	12.7	8.6	10.4	6200 (427)	3100 (213)
1/4	FNPT4-TFT-FNPT4-FNPT4-	29.7	17.5	11.4	15.0	7200 (496)	3600 (248)
3/8	FNPT6-TFT-FNPT6-FNPT6-	36.1	20.6	15.0	15.0	5600 (385)	2800 (192)
1/2	FNPT8-TFT-FNPT8-FNPT8-	39.6	25.4	18.5	19.8	5600 (385)	2800 (192)
3/4	FNPT12-TFT-FNPT12-FNPT12-	48.8	31.8	23.9	20.6	5100 (351)	2500 (172)
1	FNPT16-TFT-FNPT16-FNPT16-	48.5	42.9	29.7	25.4	6400 (440)	3200 (220)
1 1/4	FNPT20-TFT-FNPT20-FNPT20-	59.8	50.8	37.2	25.4	3100 (213)	1600 (110)
1 1/2	FNPT24-TFT-FNPT24-FNPT24-	65.0	63.5	43.3	27.7	5100 (351)	2500 (172)
Толстостенные nipples с внутренней резьбой NPT							
1/4	FNPT4-TFT1-FNPT4-FNPT4-	39.6	25.4	11.4	15.0	10000 (689)	
1/2	FNPT8-TFT1-FNPT8-FNPT8-	50.0	27.0	18.5	19.8	10000 (689)	

Внутренняя трубная коническая резьба ISO

P-BSPT Размер	Артикул для заказа	Размеры, мм				Рабочее давление, фунт/кв. дюйм (бар)	
		L	F	E	B	Нерж. сталь 316	Латунь
1/16	FBT1-TFT-FBT1-FBT1-	21.8	11.1	4.8	9.9	6700 (460)	3300 (227)
1/8	FBT2-TFT-FBT2-FBT2-	26.4	12.7	8.6	10.4	6200 (427)	3100 (213)
1/4	FBT4-TFT-FBT4-FBT4-	29.7	17.5	11.2	15.0	7200 (496)	3600 (248)
3/8	FBT6-TFT-FBT6-FBT6-	36.1	20.6	14.7	15.0	5600 (385)	2800 (192)
1/2	FBT8-TFT-FBT8-FBT8-	39.6	25.4	18.3	19.8	5600 (385)	2800 (192)
3/4	FBT12-TFT-FBT12-FBT12-	48.8	31.8	23.9	20.6	5100 (351)	2500 (172)
1	FBT16-TFT-FBT16-FBT16-	48.5	42.9	29.7	25.4	6400 (440)	3200 (220)
1 1/4	FBT20-TFT-FBT20-FBT20-	59.8	50.8	37.2	25.4	3100 (213)	1600 (110)
1 1/2	FBT24-TFT-FBT24-FBT24-	65.0	63.5	43.3	27.7	5100 (351)	2500 (172)

Крестовина с внутренней резьбой

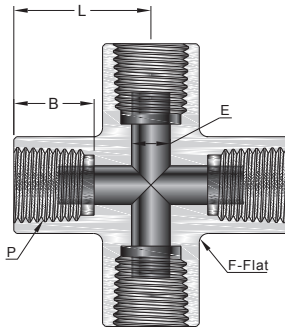

Внутренняя резьба NPT

P-NPT Размер	Артикул для заказа	Размеры, мм				Рабочее давление, фунт/кв. дюйм (бар)	
		L	F	E	B	Нерж. сталь 316	Латунь
1/16	FNPT1-TFC-FNPT1-FNPT1-FNPT1-	21.8	11.1	4.8	9.9	6700 (460)	3300 (227)
1/8	FNPT2-TFC-FNPT2-FNPT2-FNPT2-	26.4	12.7	8.6	10.4	6200 (427)	3100 (213)
1/4	FNPT4-TFC-FNPT4-FNPT4-FNPT4-	29.7	17.5	11.4	15.0	7200 (496)	3600 (248)
3/8	FNPT6-TFC-FNPT6-FNPT6-FNPT6-	36.1	20.6	15.0	15.0	5600 (385)	2800 (192)
1/2	FNPT8-TFC-FNPT8-FNPT8-FNPT8-	39.6	25.4	18.5	19.8	5600 (385)	2800 (192)
3/4	FNPT12-TFC-FNPT12-FNPT12-FNPT12-	48.8	31.8	23.9	20.6	5100 (351)	2500 (172)
1	FNPT16-TFC-FNPT16-FNPT16-FNPT16-	48.5	42.9	29.7	25.4	6400 (440)	3200 (220)

Внутренняя коническая резьба ISO

P-BSPT Размер	Артикул для заказа	Размеры, мм				Рабочее давление, фунт/кв. дюйм (бар)	
		L	F	E	B	Нерж. сталь 316	Латунь
1/16	FBT1-TFC-FBT1-FBT1-FBT1-	21.8	11.1	4.8	9.9	6700 (460)	3300 (227)
1/8	FBT2-TFC-FBT2-FBT2-FBT2-	26.4	12.7	8.6	10.4	6200 (427)	3100 (213)
1/4	FBT4-TFC-FBT4-FBT4-FBT4-	29.7	17.5	11.4	15.0	7200 (496)	3600 (248)
3/8	FBT6-TFC-FBT6-FBT6-FBT6-	36.1	20.6	15.0	15.0	5600 (385)	2800 (192)
1/2	FBT8-TFC-FBT8-FBT8-FBT8-	39.6	25.4	18.5	19.8	5600 (385)	2800 (192)
3/4	FBT12-TFC-FBT12-FBT12-FBT12-	48.8	31.8	23.9	20.6	5100 (351)	2500 (172)
1	FBT16-TFC-FBT16-FBT16-FBT16-	48.5	42.9	29.7	25.4	6400 (440)	3200 (220)

Накидная гайка M20X1.5 с внешней резьбой

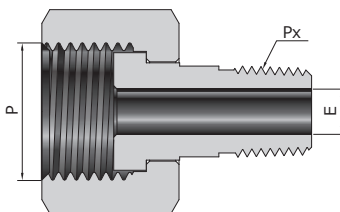

Метрическая резьба

Резьба NPT

P-Метрич. размер	Px-NPT Размер	Артикул для заказа	Размеры, мм	Рабочее давление, фунт/кв. дюйм (бар) Нерж. сталь 316
			E	
M20 x 1.5	1/8	FMS20-TPU-NPT2-	4.8	4500 (310)
M20 x 1.5	1/4	FMS20-TPU-NPT4-	7.1	4500 (310)

Метрическая резьба

Коническая резьба трубы ISO

P-Метрич. размер	Px-BSPT Размер	Артикул для заказа	Размеры, мм	Рабочее давление, фунт/кв. дюйм (бар) Нерж. сталь 316
			E	
M20 x 1.5	1/8	FMS20-TPU-MBT2-	4.8	4500 (310)
M20 x 1.5	1/4	FMS20-TPU-MBT4-	7.1	4500 (310)

Цилиндрическая резьба ISO

Резьба NPT

P-BG Размер	Px-NPT Размер	Артикул для заказа	Размеры, мм	Рабочее давление, фунт/кв. дюйм (бар) Нерж. сталь 316
			E	
1/2	1/8	FBP8-TPU-NPT2	4.8	4900 (337)
1/2	1/4	FBP8-TPU-NPT4	7.1	4900 (337)

Соединитель типа "американка"

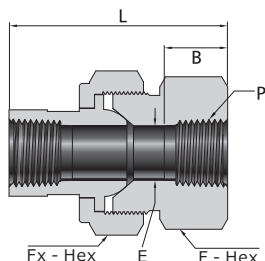

Внутренняя резьба NPT

P-NPT Размер	Артикул для заказа	Размеры, мм					Рабочее давление, фунт/кв. дюйм (бар) Нерж. сталь 316
		L	F	Fx	B	E	
1/8	FNPT2-UBJ-FNPT2-	46.0	23.8	28.6	10.4	6.8	8400 (578)
1/4	FNPT4-UBJ-FNPT4-	59.4	30.2	34.9	15.0	9.1	6600 (454)
3/8	FNPT6-UBJ-FNPT6-	63.5	33.3	38.1	15.0	13.2	5300 (365)
1/2	FNPT8-UBJ-FNPT8-	68.3	41.3	44.5	19.8	15.7	6000 (410)
3/4	FNPT12-UBJ-FNPT12-	79.2	47.6	54.0	20.6	22.4	4600 (316)
1	FNPT16-UBJ-FNPT16-	90.4	60.3	63.5	25.4	26.2	6800 (468)

Female ISO Tapered Threads

P-BSPT Размер	Артикул для заказа	Размеры, мм					Рабочее давление, фунт/кв. дюйм (бар) Нерж. сталь 316
		L	F	Fx	B	E	
1/8	FBT2-UBJ-FBT2-	46.0	23.8	28.6	10.4	6.8	8400 (578)
1/4	FBT4-UBJ-FBT4-	59.4	30.2	34.9	15.0	9.1	6600 (454)
3/8	FBT6-UBJ-FBT6-	63.5	33.3	38.1	15.0	13.2	5300 (365)
1/2	FBT8-UBJ-FBT8-	68.3	41.3	44.5	19.8	15.7	6000 (410)
3/4	FBT12-UBJ-FBT12-	79.2	47.6	54.0	20.6	22.4	4600 (316)
1	FBT16-UBJ-FBT16-	90.4	60.3	63.5	25.4	26.2	6800 (468)

Разъёмный переходник под приварку M20x1.5 (UGJ)

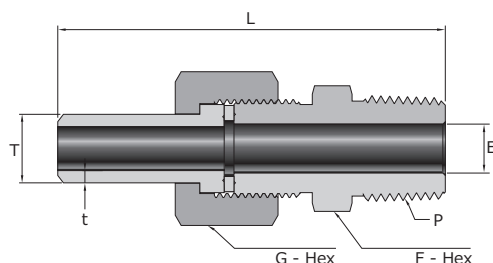

Резьба NPT

Метрическая трубка

P-NPT Размер	Трубка, мм	t-толщина стенки (мм)	Артикул для заказа	Размеры, мм (дюйм)				Рабочее давление, фунт/кв. дюйм (бар)
				L	F	G	E	
1/8	14	2.0	MBW14-UGJ-NPT2-	69.0 (2.72)	19.0 (0.75)	22.0 (0.87)	4.8 (0.19)	6280 (433)
1/4	6	1.8	MBW6-UGJ-NPT4-	60.0 (2.36)	14.0 (0.55)	14.0 (0.55)	3.0 (0.12)	8240 (566)
1/4	8	1.8	MBW8-UGJ-NPT4-	73.2 (2.88)	14.0 (0.55)	16.0 (0.63)	4.0 (0.16)	8240 (566)
1/4	10	2.2	MBW10-UGJ-NPT4-	73.2 (2.88)	15.0 (0.59)	18.0 (0.71)	6.0 (0.24)	8160 (563)
1/4	12	2.2	MBW12-UGJ-NPT4-	73.2 (2.88)	18.0 (0.71)	22.0 (0.87)	7.0 (0.28)	6470 (446)
1/4	14	2.0	MBW14-UGJ-NPT4-	73.2 (2.88)	19.0 (0.75)	22.0 (0.87)	7.1 (0.28)	6280 (433)
1/4	16	3.0	MBW16-UGJ-NPT4-	73.2 (2.88)	22.0 (0.87)	25.0 (0.98)	7.1 (0.28)	6140 (423)
1/4	18	2.8	MBW18-UGJ-NPT4-	74.2 (2.92)	24.0 (0.94)	27.0 (1.06)	7.1 (0.28)	5670 (392)
3/8	14	2.0	MBW14-UGJ-NPT6-	73.2 (2.88)	19.0 (0.75)	22.0 (0.87)	9.7 (0.38)	6280 (433)
1/2	12	2.2	MBW12-UGJ-NPT8-	78.0 (3.07)	18.0 (0.71)	22.0 (0.87)	7.0 (0.28)	6470 (446)
1/2	14	2.0	MBW14-UGJ-NPT8-	78.0 (3.07)	19.0 (0.75)	22.0 (0.87)	9.0 (0.35)	6280 (433)
1/2	16	3.0	MBW16-UGJ-NPT8-	78.0 (3.07)	22.0 (0.87)	25.0 (0.98)	10.0 (0.39)	6140 (423)
1/2	22	3.0	MBW22-UGJ-NPT8-	82.0 (3.23)	30.0 (1.18)	32.0 (1.26)	11.9 (0.47)	4620 (319)
1/2	25	2.8	MBW25-UGJ-NPT8-	86.0 (3.39)	32.0 (1.26)	35.0 (1.38)	11.9 (0.47)	4730 (326)
1	25	3.5	MBW25-UGJ-NPT16-	103.0 (4.06)	35.0 (1.38)	35.0 (1.38)	17.0 (0.67)	4730 (326)

Разъёмный переходник под приварку M20x1.5 (UOJ)

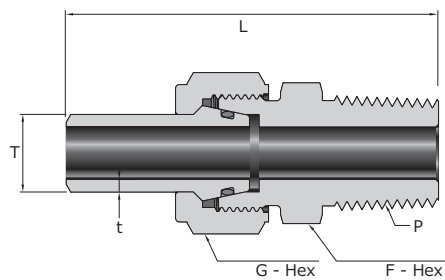

NPT Резьба

Метрическая трубка

P-NPT Размер	Трубка, мм	t-толщина стенки (мм)	Артикул для заказа	Размеры, мм (дюйм)				Рабочее давление, фунт/кв. дюйм (бар)
				L	F	G	E	
1/8	14	2.0	MBW14-UOJ-NPT2-	69.0 (2.72)	19.0 (0.75)	22.0 (0.87)	4.8 (0.19)	6280 (433)
1/4	6	1.8	MBW6-UOJ-NPT4-	60.0 (2.36)	14.0 (0.55)	14.0 (0.55)	3.0 (0.12)	8240 (566)
1/4	8	1.8	MBW8-UOJ-NPT4-	73.2 (2.88)	14.0 (0.55)	16.0 (0.63)	4.0 (0.16)	8240 (566)
1/4	10	2.2	MBW10-UOJ-NPT4-	73.2 (2.88)	15.0 (0.59)	18.0 (0.71)	6.0 (0.24)	8160 (563)
1/4	12	2.2	MBW12-UOJ-NPT4-	73.2 (2.88)	18.0 (0.71)	22.0 (0.87)	7.0 (0.28)	6470 (446)
1/4	14	2.0	MBW14-UOJ-NPT4-	73.2 (2.88)	19.0 (0.75)	22.0 (0.87)	7.1 (0.28)	6280 (433)
1/4	16	3.0	MBW16-UOJ-NPT4-	73.2 (2.88)	22.0 (0.87)	25.0 (0.98)	7.1 (0.28)	6140 (423)
1/4	18	2.8	MBW18-UOJ-NPT4-	74.2 (2.92)	24.0 (0.94)	27.0 (1.06)	7.1 (0.28)	5670 (392)
3/8	14	2.0	MBW14-UOJ-NPT6-	73.2 (2.88)	19.0 (0.75)	22.0 (0.87)	9.7 (0.38)	6280 (433)
1/2	12	2.2	MBW12-UOJ-NPT8-	78.0 (3.07)	18.0 (0.71)	22.0 (0.87)	7.0 (0.28)	6470 (446)
1/2	14	2.0	MBW14-UOJ-NPT8-	78.0 (3.07)	19.0 (0.75)	22.0 (0.87)	9.0 (0.35)	6280 (433)
1/2	16	3.0	MBW16-UOJ-NPT8-	78.0 (3.07)	22.0 (0.87)	25.0 (0.98)	10.0 (0.39)	6140 (423)
1/2	22	3.0	MBW22-UOJ-NPT8-	82.0 (3.23)	30.0 (1.18)	32.0 (1.26)	11.9 (0.47)	4620 (319)
1/2	25	2.8	MBW25-UOJ-NPT8-	86.0 (3.39)	32.0 (1.26)	35.0 (1.38)	11.9 (0.47)	4730 (326)
1	25	3.5	MBW25-UOJ-NPT16-	103.0 (4.06)	35.0 (1.38)	35.0 (1.38)	17.0 (0.67)	4730 (326)

Тип соединения 1	Размер соединения 1	Конфигурация	Соединения 2,3 и 4	Материал
FNPT Внутренняя RT	2 1/8 дюйма	TP Заглушка с внешней резьбой	Такое же как 1, ЛИБО:	316 Нержавеющая сталь марки 316
NPT Внешняя RT	4 1/4 дюйма	TNR Заглушка с внутренним шестигранником	FMS Внутренняя ISO	316L Нержавеющая сталь марки 316L
NPTO Уплотнительные кольца из эластомеров с внешней NPT	5 5/16-24	TCN Ниппель таркий Специальные ниптели Ниппель	MS Внешняя ISO для B	304 Нержавеющая сталь марки 304
FVT Внутренняя BSPT	6 3/8 дюйма ИЛИ 3/8-24	TPN шестигранный Удлиненный ниппель	BPMS Внешняя ISO для B	304L Нержавеющая сталь марки 304L
MVT Внешняя VPT	7 7/16-20	TLN ниппель Переходная муфта	BSMS Внешняя ISO для B	A20 Сплав 20
MVTO Уплотнительные кольца из эластомеров с внешней BSPT	8 9 1/2 дюйма ИЛИ M8 x 1	TRB Заглушка с внутренней резьбой	M5O Уплотнительные кольца из эластомеров с внешней ISO	A400 Сплав 400
FVP Внутренняя BSPP	10 9/16-18	PC Муфта с внутренней резьбой	FST Внутренняя AE	A600 Сплав 600
PMVP Внешняя BSPP for BP	12 M10 x 1	THC Соединитель типа «американка»	MST Внешняя AE для B	A825 Сплав 825
MBS Внешняя BSPP for BS	14 3/4 дюйма ИЛИ M12 x 1.5 ИЛИ 3/4-16 M14 x 1.5 ИЛИ 7/8-14	UBJ Соединитель типа «американка»	BPST Внешняя AE для B	AZ76 Сплав AZ76
MVP Внешняя BSPP for BG	16 1 дюйм ИЛИ M16 x 1.5	UGJ Разъемный переходник под приварку	BSST Внешняя SA для BS	DU7 Дулекс 2507
	17 1 1/16-12	UOJ Переходник	OST Уплотнительные кольца с внешней SAE	BR Латунь
	18 M18 x 1.5	TA Угольник с внешней резьбой	PPT Позиционируемая цилиндрическая резьба BSP	CS Улеродистая сталь
	19 1 3/16-12	TME Угольник с внутренней и внешней резьбой	PMS Позиционируемая цилиндрическая резьба BO	TI Титан
	20 1 1/4 дюйма ИЛИ M20 x 1.5	TSE Угольник с внутренней и внешней резьбой под 45°	PST Позиционируемая цилиндрическая резьба SAE	
	21 1 5/16-12	T45E Угольник с внутренней резьбой		
	22 M22 x 1.5	TFE Угольник с внешней резьбой		
	24 1 1/2 дюйма ИЛИ M24 x 1.5	T45FE Угольник под 45° с внутренней резьбой		
	26 1 5/8-12	TMT Тройник с внешней резьбой		
	27 M27 x 2	TFBT Тройник с внешними резьбами и внутренней резьбой снизу		
	30 1 7/8-12 ИЛИ M30 x 2	TFRT Тройник с внешними резьбами и внутренней резьбой сверху		
	32 2 дюйма	TMST Тройник с внутренними резьбами и внешней резьбой сверху		
		TMBT Тройник с внутренними резьбами и внешней резьбой снизу		
		TFT Тройник с внутренней резьбой		
		TFC Крестовина с внутренней резьбой		

